

Barbed fittings









FESTO



Barbed fittings

Product range overview





FESTO

Design	Version	Type	Pneumatic connection 1				Pneumatic connection 2		→ Page/ Internet	
			M thread	G thread	Barbed connector	For tubing O.D. [mm]	Barbed connector	For tubing O.D. [mm]		
Straight shape	Barbed fitting with male thread and external hex									
		N	M5	–	–	–	–	PK-3 PK-4	–	5
	Barbed fitting with male thread and external hex									
		CN	M3	–	–	–	–	–	3, 4	6
			M5	–	–	–	–	–	3, 4, 6	
			–	G1/8	–	–	–	–	4, 6, 8	
			–	G1/4	–	–	–	–	6, 8	
			–	G3/8	–	–	–	–	8	
	Barbed fitting with male thread and external hex – stainless steel design									
		CRCN	M5	–	–	–	–	–	3, 4, 6	7
	–		G1/8	–	–	–	–	4, 6, 8		
	–		G1/4	–	–	–	–	6, 8		
	–		G3/8	–	–	–	–	8		
Barbed bulkhead fitting										
	SCN	–	–	–	–	3	–	–	8	
		–	–	–	–	4	–	–		
		–	–	–	–	6	–	–		
		–	–	–	–	8	–	–		
Barbed tubing connector										
	RTU	–	–	PK-2	–	PK-2	–	9		
		–	–	PK-3	–	PK-2, PK-3, PK-4	–			
		–	–	PK-4	–	PK-4, PK-6	–			
		–	–	PK-6	–	PK-6	–			
L-shape	Barbed L-fitting with male thread – rotatable 360°									
		LCN	M3	–	–	–	–	–	3, 4	10
			M5	–	–	–	–	–	3, 4, 6	
			–	G1/8	–	–	–	–	4, 6, 8	
			–	G1/4	–	–	–	–	6, 8	
			–	G3/8	–	–	–	–	8	
	Barbed L-fitting with male thread – extended housing section – rotatable 360°									
		LCNH	M5	–	–	–	–	–	3, 4, 6	12
			–	G1/8	–	–	–	–	4, 6, 8	
			–	G1/4	–	–	–	–	6, 8	
	–		G3/8	–	–	–	–	8		
Barbed L-connector										
	L-PK	–	–	PK-2	–	–	–	14		
		–	–	PK-3	–	–	–			
		–	–	PK-4	–	–	–			
		–	–	PK-6	–	–	–			

Barbed fittings

Product range overview

FESTO

Design	Version	Type	Pneumatic connection 1				Pneumatic connection 2		→ Page/ Internet
			M thread	G thread	Barbed connector	For tubing O.D. [mm]	Barbed connector	For tubing O.D. [mm]	
T-shape	Barbed T-fitting with male thread – rotatable 360°								
		TCN	M3	–	–	–	–	3, 4	15
			M5	–	–	–	–	3, 4, 6	
			–	G1/8	–	–	–	4, 6, 8	
			–	G1/4	–	–	–	6, 8	
			–	G3/8	–	–	–	8	
	Barbed T-connector								
		T-PK	–	–	PK-2	–	–	–	16
			–	–	PK-3	–	–	–	
			–	–	PK-4	–	–	–	
–			–	PK-6	–	–	–		
Y-shape	Barbed Y-connector								
		Y-PK	–	–	PK-2	–	–	–	17
			–	–	PK-3	–	–	–	
			–	–	PK-4	–	–	–	
			–	–	PK-6	–	–	–	
Barbed T-connector									
	FCN	–	–	–	3	–	3, 4	18	
		–	–	–	4	–	4, 6		
		–	–	–	6	–	6, 8		
		–	–	–	8	–	8		

Tube assembly/dismantling

Assembly:

1. Hold the tubing as close to the end as possible.
2. Rotate the tubing (approx. 90°) around the barbed axis while attaching it.

Dismantling:

1. Use a knife to cut off the tubing behind the sealing and support edge.
Be careful not to damage the barbed connector on the sealing and support edge.
2. Remove the tubing.

Available supporting accessories

Connecting pliers ZMS-PK-3/4

→ Internet: zms



Disconnecting pliers ZDS-PK-3,

ZDS-PK-4

→ Internet: zds

Barbed hose fittings C-P/N-P, for hose clip

Product range overview

Design	Version	Type	Pneumatic connection D1			Pneumatic connection D2	→ Page/ Internet
			G thread	R thread	NPT thread	Barbed connector	
Barbed hose fitting							
	C-...-P		G1/8	-	-	PK-6	19
			G1/4	-	-	PK-6, PK-9	
			G3/8	-	-	PK-6, PK-9	
			G1/2	-	-	PK-13	
Barbed hose fitting with sealing ring (aluminium and brass design)							
	N-...-P N-...-MS		G1/8	-	-	PK-6	20
			G1/4	-	-	PK-6, PK-9	
			G3/8	-	-	PK-6, PK-9, PK-13	
			G1/2	-	-	PK-9, PK-13	
			G3/4	-	-	PK-13, PK-19	
			-	R1	-	PK-19	
			-	-	NPT3/4-14	PK-19	
-	-	NPT1-11 1/2	PK-19				
Hose clip to DIN 3017							
	SK						22

Barbed fittings N/CN

Technical data

Barbed fittings N

with external thread and external hexagon

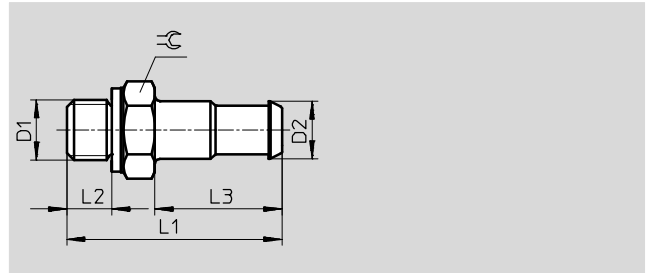

General technical data	
Type of seal on threaded plug	Sealing ring

Operating and environmental conditions	
Operating medium	Compressed air to ISO 8573-1:2010 [7:-:-]
Note on operating/pilot medium	Lubricated operation possible (in which case lubricated operation will always be required)

Materials	
Housing	Brass

Dimensions and ordering data											
Pneumatic connection		Nominal width [mm]	D2	L1	L2	L3	⌀	Weight/ piece [g]	Part No.	Type	PU ¹⁾
D1											
Metric thread with sealing ring											
M5	PK-3	2.5	3.6	16	3.5	8.5	7	1	4446	N-M5-PK-3	10
	PK-4	2.5	4.8	18	3.5	10.5	7	2	4902	N-M5-PK-4	10

1) Packaging unit

Barbed fittings N/CN

Technical data

FESTO

Barbed fitting CN

with external thread and external hexagon

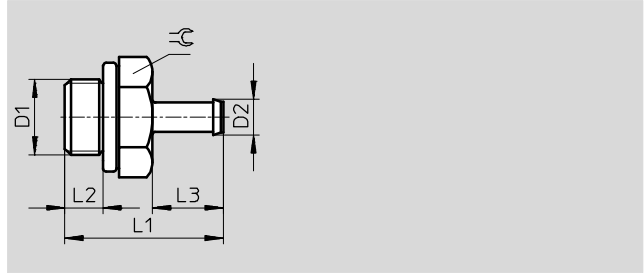

General technical data	
Type of seal on threaded plug	Sealing ring
Operating and environmental conditions	
Operating pressure [bar]	-0.95 ... +10
Operating medium	Compressed air to ISO 8573-1:2010 [7:-:-]
Note on operating/pilot medium	Lubricated operation possible (in which case lubricated operation will always be required)
Ambient temperature [°C]	0 ... +60
Corrosion resistance class CRC ¹⁾	2

- 1) Corrosion resistance class CRC 2 to Festo standard FN 940070
Moderate corrosion stress. Indoor applications in which condensation may occur. External visible parts with primarily decorative requirements for the surface and which are in direct contact with the ambient atmosphere typical for industrial applications.

Materials			
Pneumatic connection 1	Male thread M3	Male thread M5	Male thread G1/8/G1/4/G3/8
Housing	High-alloy steel	Steel	Aluminium
Note on materials	RoHS-compliant		

Dimensions and ordering data										
Pneumatic connection		Nominal width [mm]	D2	L1	L2	L3	⌀	Part No.	Type	PU ¹⁾
External thread	For tubing O.D. [mm]									
D1										
M thread with sealing ring										
M3	3	1.5	2.6	10	3	5	4.5	15871	CN-M3-PK-2	10
	4	1.5	3.4	11	3	6	4.5	15872	CN-M3-PK-3	10
M5	3	1.5	2.95	13.8	3.8	6	7	19521	CN-M5-PK-2	10
	4	2.5	3.6	17.5	3.8	9.7	7	12255	CN-M5-PK-3	10
	6	2.5	4.8	19.5	3.8	11.7	7	12256	CN-M5-PK-4	10
G thread with sealing ring										
G1/8	4	2.5	3.6	20.2	4.9	9.7	13	11944	CN-1/8-PK-3	10
	6	3.2	4.8	22.2	4.9	11.7	13	11945	CN-1/8-PK-4	10
	8	5.3	7	24.5	4.9	14	13	11946	CN-1/8-PK-6	10
G1/4	6	3.2	4.8	24.7	5.8	11.7	17	11947	CN-1/4-PK-4	10
	8	5.3	7	27	5.8	14	17	11948	CN-1/4-PK-6	10
G3/8	8	5.3	7	28	6.8	14	19	11949	CN-3/8-PK-6	10

- 1) Packaging unit

Barbed fittings N/CN

Technical data

Barbed fitting CRCN

Stainless steel design
with external thread and external
hexagon

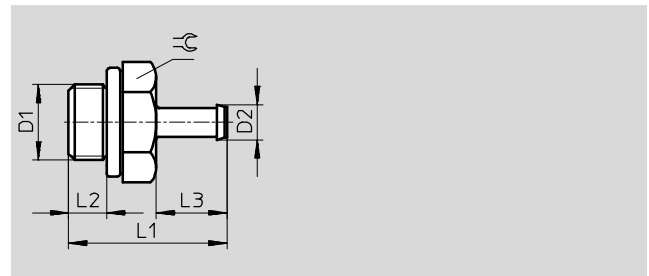

General technical data	
Type of seal on threaded plug	Sealing ring
Operating and environmental conditions	
Operating pressure [bar]	-0.95 ... +10
complete temperature range	
Operating medium	Compressed air in accordance with ISO 8573-1:2010 [7:-:-]
Note on operating/pilot medium	Lubricated operation possible (in which case lubricated operation will always be required)
Ambient temperature [°C]	0 ... +60
Corrosion resistance class CRC ¹⁾	2
Food-safe ²⁾	See supplementary material information

- 1) Corrosion resistance class CRC 2 to Festo standard FN 940070
Moderate corrosion stress. Indoor applications in which condensation may occur. External visible parts with primarily decorative requirements for the surface and which are in direct contact with the ambient atmosphere typical for industrial applications.
- 2) Additional information www.festo.com/sp → Certificates.

Materials	
Housing	High-alloy stainless steel
Threaded seal	Stainless steel, FPM
Note on materials	RoHS-compliant

Dimensions and ordering data											
Pneumatic connection		Nominal width [mm]	D2	L1	L2	L3	⌀	Weight/ piece [g]	Part No.	Type	PU ¹⁾
External thread D1	For tubing O.D. [mm]										
M thread with sealing ring											
M5	3	1.5	2.95	13.8	3.8	6	7	1.8	30985	CRCN-M5-PK-2	10
	4	2.5	3.6	17.5	3.8	9.7	7	1.74	13967	CRCN-M5-PK-3	10
	6	2.5	4.8	19.5	3.8	11.7	7	2.58	13968	CRCN-M5-PK-4	10
G thread with sealing ring											
G ¹ / ₈	4	2.5	3.6	20.2	4.9	9.7	13	7.52	13969	CRCN-¹/₈-PK-3	10
	6	3.2	4.8	22.2	4.9	11.7	13	7.86	13970	CRCN-¹/₈-PK-4	10
	8	5.3	7	24.5	4.9	14	13	7.5	13971	CRCN-¹/₈-PK-6	10
G ¹ / ₄	6	3.2	4.8	24.7	5.8	11.7	17	17.73	13972	CRCN-¹/₄-PK-4	1
	8	5.3	7	27	5.8	14	17	16.5	13973	CRCN-¹/₄-PK-6	1
G ³ / ₈	8	5.3	7	28	6.8	14	19	23.7	13974	CRCN-³/₈-PK-6	1

1) Packaging unit

Barbed fittings N/CN

Technical data



Barbed bulkhead fitting SCN

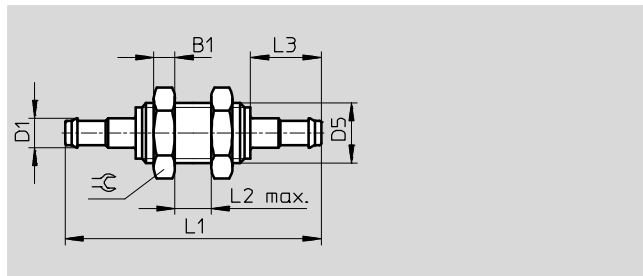

Operating and environmental conditions	
Operating pressure [bar]	-0.95 ... +10
Operating medium	Compressed air to ISO 8573-1:2010 [7:-:-]
Note on operating/pilot medium	Lubricated operation possible (in which case lubricated operation will always be required)
Ambient temperature [°C]	0 ... +60
Corrosion resistance class CRC ¹⁾	2

1) Corrosion resistance class CRC 2 to Festo standard FN 940070
 Moderate corrosion stress. Indoor applications in which condensation may occur. External visible parts with primarily decorative requirements for the surface and which are in direct contact with the ambient atmosphere typical for industrial applications.

Materials	
Housing	Aluminium
Note on materials	RoHS-compliant

Dimensions and ordering data												
Pneumatic connection for tubing O.D. [mm]	Nominal width [mm]	B1	D1	D5	L1	L2	L3	≈	Weight/ piece [g]	Part No.	Type	PU ¹⁾
3	1.5	2.2	2.95	M4	23.4	6	6	7	1	19528	SCN-PK-2	10
4	1.9	3.2	3.6	M6x0.75	35.3	8	9.7	10	4	11972	SCN-PK-3	10
6	2.8	3.5	4.8	M10x1	42.4	10	11.7	13	7	11973	SCN-PK-4	10
8	4.8	4	7	M12x1	48	10	14	17	10	11974	SCN-PK-6	10

1) Packaging unit

Barbed fittings N/CN

Technical data

Barbed tubing connector RTU

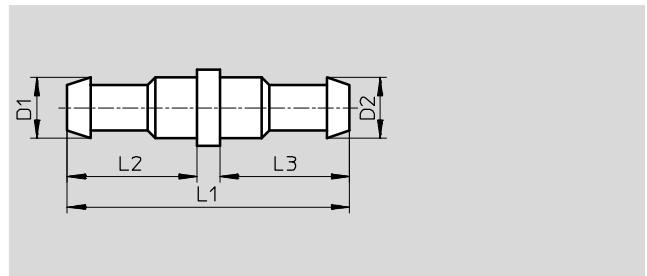

Operating and environmental conditions	
Operating medium	Compressed air to ISO 8573-1:2010 [7:-:-]
Note on operating/pilot medium	Lubricated operation possible (in which case lubricated operation will always be required)

Materials	
Housing	Brass
Note on materials	RoHS-compliant

Dimensions and ordering data											
Pneumatic connection		Nominal width [mm]	D1	D2	L1	L2	L3	Weight/ piece [g]	Part No.	Type	PU ¹⁾
PK-2	PK-2	1.5	2.95	2.95	14	6	6	1	19541	RTU-PK-2/2-B	10
PK-3	PK-2	1.5	3.6	2.95	17.7	9.7	6	1	19542	RTU-PK-3/2	10
	PK-3	2.5	3.6	3.6	19	8.5	8.5	1	4805	RTU-PK-3/3	10
	PK-4	2.5	3.6	4.8	20	8.5	10.5	2	4499	RTU-PK-3/4	10
PK-4	PK-4	3.4	4.8	4.8	23	10.5	10.5	2	4806	RTU-PK-4/4	10
	PK-6	3.4	4.8	7	25.5	10.5	13	2	7604	RTU-PK-4/6	10
PK-6	PK-6	5.3	7	7	28	13	13	3	7605	RTU-PK-6/6	10

1) Packaging unit

Barbed fittings N/CN

Technical data



Barbed L-fitting LCN

With external thread

Rotatable 360°

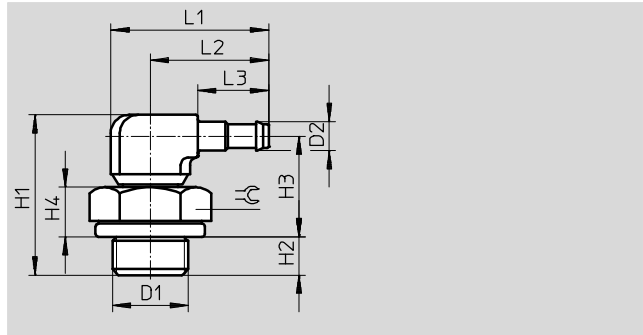

General technical data	
Type of seal on threaded plug	Sealing ring

Operating and environmental conditions	
Operating pressure [bar]	-0.95 ... +10
Operating medium	Compressed air to ISO 8573-1:2010 [7:-:-]
Note on operating/pilot medium	Lubricated operation possible (in which case lubricated operation will always be required)
Ambient temperature [°C]	0 ... +60
Corrosion resistance class CRC ¹⁾	2

1) Corrosion resistance class CRC 2 to Festo standard FN 940070
 Moderate corrosion stress. Indoor applications in which condensation may occur. External visible parts with primarily decorative requirements for the surface and which are in direct contact with the ambient atmosphere typical for industrial applications.

Materials			
Pneumatic connection 1	Male thread M3	Male thread M5	Male thread G1/8/G1/4/G3/8
Housing	High-alloy steel	Steel	Aluminium
	Die-cast zinc		
Note on materials	RoHS-compliant		

Dimensions										
Pneumatic connection		D2	H1	H2	H3	H4	L1	L2	L3	⌀
External thread	For tubing O.D.									
D1	[mm]									
M thread with sealing ring										
M3	3	2.95	14	2.8	9.2	3.0	12.2	9.6	6	4.5
	4	3.6	15.2	2.8	9.8	3.0	15.9	13.3	9.7	4.5
M5	3	2.95	16	3.8	10.2	4.0	12.2	9.6	6	7
	4	3.6	20.1	3.8	13.7	4.0	18.7	14.7	9.7	7
	6	4.8	21.4	3.8	13.9	4.0	20.7	16.7	11.7	7
G thread with sealing ring										
G1/8	4	3.6	21.2	4.9	13.7	5.6	24	17.5	9.7	13
	6	4.8	22.55	4.9	14.15	5.6	26	19.5	11.7	13
	8	7	24.45	4.9	15.15	5.6	28.5	22	14.2	13
G1/4	6	4.8	25.05	5.8	15.75	7.2	26	19.5	11.7	17
	8	7	26.95	5.8	16.75	7.2	28.5	22	14.2	17
G3/8	8	7	27.95	6.8	16.75	7.2	28.5	22	14.2	19

Barbed fittings N/CN

Technical data

Ordering data						
Pneumatic connection		Nominal width	Weight/ piece	Part No.	Type	PU ¹⁾
External thread D1	For tubing O.D. [mm]	[mm]	[g]			
M thread with sealing ring						
M3	3	1.3	2	30491	LCN-M3-PK-2-B	10
	4	2.0	2	30982	LCN-M3-PK-3	10
M5	3	1.3	4	19523	LCN-M5-PK-2	10
	4	2.0	5	12257	LCN-M5-PK-3	10
	6	2.9	6	12258	LCN-M5-PK-4	10
G thread with sealing ring						
G $\frac{1}{8}$	4	2.0	9	11955	LCN-$\frac{1}{8}$-PK-3	10
	6	2.9	10	11956	LCN-$\frac{1}{8}$-PK-4	10
	8	4.9	11	11957	LCN-$\frac{1}{8}$-PK-6	10
G $\frac{1}{4}$	6	2.9	13	12958	LCN-$\frac{1}{4}$-PK-4	10
	8	4.9	15	12959	LCN-$\frac{1}{4}$-PK-6	10
G $\frac{3}{8}$	8	4.9	20	12960	LCN-$\frac{3}{8}$-PK-6	10

1) Packaging unit

Barbed fittings N/CN

Technical data



Barbed L-fitting

LCNH

with external thread

Rotatable 360°

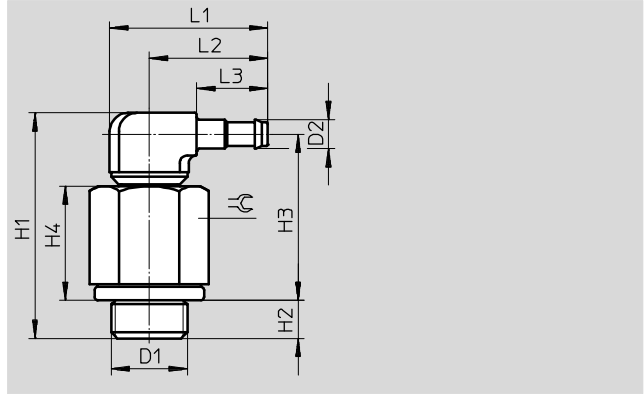

General technical data

Type of seal on threaded plug	Sealing ring
-------------------------------	--------------

Operating and environmental conditions

Operating pressure [bar]	-0.95 ... +10
Operating medium	Compressed air to ISO 8573-1:2010 [7:-:-]
Note on operating/pilot medium	Lubricated operation possible (in which case lubricated operation will always be required)
Ambient temperature [°C]	0 ... +60
Corrosion resistance class CRC ¹⁾	2

1) Corrosion resistance class CRC 2 to Festo standard FN 940070
 Moderate corrosion stress. Indoor applications in which condensation may occur. External visible parts with primarily decorative requirements for the surface and which are in direct contact with the ambient atmosphere typical for industrial applications.

Materials

Pneumatic connection 1	Male thread M5	Male thread G1/8/G1/4/G3/8
Housing	Steel	Aluminium
	Die-cast zinc	
Note on materials	RoHS-compliant	

Dimensions

Pneumatic connection		D2	H1	H2	H3	H4	L1	L2	L3	⌀
External thread	For tubing O.D.									
D1	[mm]									
M thread with sealing ring										
M5	3	2.95	26.9	3.8	21.1	14.9	12.2	9.6	6	7
	4	3.6	28.7	3.8	22.3	12.6	18.7	14.7	9.7	7
	6	4.8	30.2	3.8	22.9	12.6	20.7	16.7	11.7	7
G thread with sealing ring										
G1/8	4	3.6	31.8	4.9	24.3	16.2	24	17.5	9.7	13
	6	4.8	33.15	4.9	24.75	16.2	26	19.5	11.7	13
	8	7	35.05	4.9	25.75	16.2	28.5	22	14.2	13
G1/4	6	4.8	35.65	5.8	26.35	17.8	26	19.5	11.7	17
	8	7	37.55	5.8	27.35	17.8	28.5	22	14.2	17
G3/8	8	7	38.55	6.8	27.35	17.8	28.5	22	14.2	19

Barbed fittings N/CN

Technical data

Ordering data						
Pneumatic connection		Nominal width		Weight/ piece [g]	Part No. Type	PU ¹⁾
External thread D1	For tubing O.D. [mm]	[mm]				
M thread with sealing ring						
M5	3	1.3	8	35982	LCNH-M5-PK-2	10
	4	2.0	9	35983	LCNH-M5-PK-3	10
	6	2.9	10	35984	LCNH-M5-PK-4	10
G thread with sealing ring						
G ¹ / ₈	4	2.0	13	35985	LCNH-¹/₈-PK-3	10
	6	2.9	14	35986	LCNH-¹/₈-PK-4	10
	8	4.9	16	35987	LCNH-¹/₈-PK-6	10
G ¹ / ₄	6	2.9	21	35988	LCNH-¹/₄-PK-4	10
	8	4.9	22	35989	LCNH-¹/₄-PK-6	10
G ³ / ₈	8	4.9	29	35990	LCNH-³/₈-PK-6	10

1) Packaging unit

Barbed fittings N/CN

Technical data



Barbed L-connector L-PK

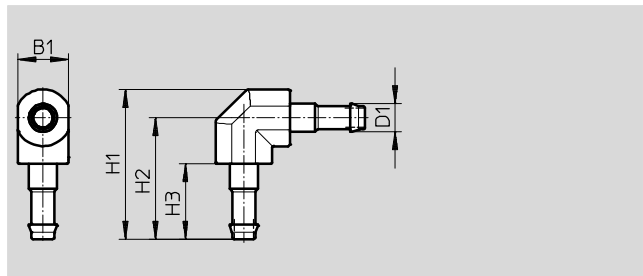

Operating and environmental conditions	
Operating medium	Compressed air to ISO 8573-1:2010 [7:-:-]
Note on operating/pilot medium	Lubricated operation possible (in which case lubricated operation will always be required)

Materials	
Housing	Brass, POM
Note on materials	RoHS-compliant

Dimensions and ordering data										
Pneumatic connection	Nominal width [mm]	B1	D1	H1	H2	H3	Weight/ piece [g]	Part No.	Type	PU ¹⁾
PK-2	1.5	4	2.95	12.2	10.2	6	1	19539	L-PK-2	10
PK-3	2.5	6.5	3.6	19.25	15.6	9.7	1	7473	L-PK-3	10
PK-4	3.4	7.8	4.8	23.1	18.7	11.7	2	9584	L-PK-4	10
PK-6	5.3	10.4	7	31.5	26.3	14	7	150012	L-PK-6	10

1) Packaging unit

Barbed fittings N/CN

Technical data

FESTO

Barbed T-fitting, TCN
with external thread
Rotatable 360°

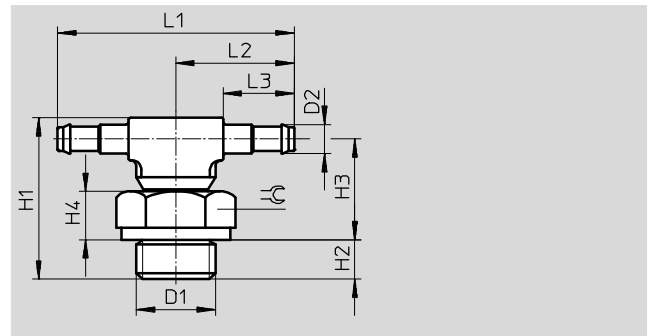

General technical data	
Type of seal on threaded plug	Sealing ring
Operating and environmental conditions	
Operating pressure [bar]	-0.95 ... +10
Operating medium	Compressed air to ISO 8573-1:2010 [7:-:-]
Note on operating/pilot medium	Lubricated operation possible (in which case lubricated operation will always be required)
Ambient temperature [°C]	0 ... +60
Corrosion resistance class CRC ¹⁾	2

1) Corrosion resistance class CRC 2 to Festo standard FN 940070
Moderate corrosion stress. Indoor applications in which condensation may occur. External visible parts with primarily decorative requirements for the surface and which are in direct contact with the ambient atmosphere typical for industrial applications.

Materials			
Pneumatic connection 1	Male thread M3	Male thread M5	Male thread G ¹ / ₈ /G ¹ / ₄ /G ³ / ₈
Housing	High-alloy steel	Steel	Aluminium
	Die-cast zinc		
Note on materials	RoHS-compliant		

Dimensions and ordering data														
Pneumatic connection		Nominal width	D2	H1	H2	H3	H4	L1	L2	L3	⊕	Part No.	Type	PU ¹⁾
External thread D1	For tubing O.D. [mm]	[mm]												
M thread with sealing ring														
M3	3	1.3	2.95	14	2.8	9.2	3.0	19.2	9.6	6	4.5	30492	TCN-M3-PK-2	10
	4	2.0	3.6	15.2	2.8	9.8	3.0	26.6	13.3	9.7	4.5	30983	TCN-M3-PK-3	10
M5	3	1.3	2.95	16	3.8	10.2	4.0	19.2	9.6	6	7	19525	TCN-M5-PK-2	10
	4	2.0	3.6	20.1	3.8	13.7	4.0	29.4	14.7	9.7	7	12259	TCN-M5-PK-3	10
	6	2.9	4.8	18.1	3.8	14.3	4.0	33.4	16.7	11.7	7	12432	TCN-M5-PK-4	10
G thread with sealing ring														
G ¹ / ₈	4	2.0	3.6	21.2	4.9	13.7	5.6	35	17.5	9.7	13	11961	TCN-1/8-PK-3	10
	6	2.9	4.8	22.55	4.9	14.15	5.6	39	19.5	11.7	13	11962	TCN-1/8-PK-4	10
	8	4.9	7	24.45	4.9	15.15	5.6	44	22	14.2	13	11963	TCN-1/8-PK-6	10
G ¹ / ₄	6	2.9	4.8	25.05	5.8	15.75	7.2	39	19.5	11.7	17	11964	TCN-1/4-PK-4	10
	8	4.9	7	26.95	5.8	16.75	7.2	44	22	14.2	17	11965	TCN-1/4-PK-6	10
G ³ / ₈	8	4.9	7	27.95	6.8	16.75	7.2	44	22	14.2	19	11966	TCN-3/8-PK-6	10

1) Packaging unit

Barbed fittings N/CN

Technical data



Barbed T-connector T-PK

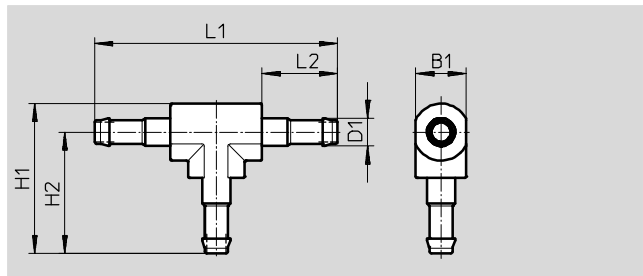

Operating and environmental conditions	
Operating medium	Compressed air to ISO 8573-1:2010 [7:-:-]
Note on operating/pilot medium	Lubricated operation possible (in which case lubricated operation will always be required)

Materials	
Housing	Brass, POM
Note on materials	RoHS-compliant

Dimensions and ordering data											
Pneumatic connection	Nominal width [mm]	B1	D1	H1	H2	L1	L2	Weight/ piece [g]	Part No.	Type	PU ¹⁾
PK-2	1.5	4	2.95	12.2	10.2	20.4	6	1	30919	T-PK-2	10
PK-3	2.5	6.5	3.6	19.25	15.6	31.2	9.7	2	7267	T-PK-3	10
PK-4	3.4	7.8	4.8	23	18.7	37.4	11.7	3	9585	T-PK-4	10
PK-6	5.3	10.4	7	31.5	26.3	52.6	14	11	150015	T-PK-6	10

1) Packaging unit

Barbed fittings N/CN

Technical data

Barbed Y-connector Y-PK

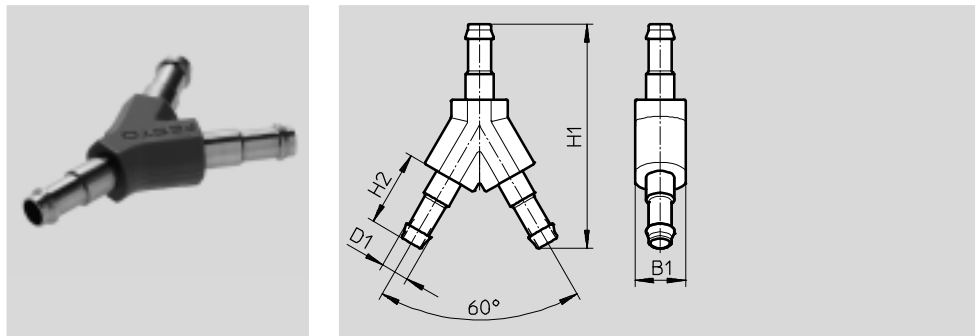

Operating and environmental conditions	
Operating medium	Compressed air to ISO 8573-1:2010 [7:-:-]
Note on operating/pilot medium	Lubricated operation possible (in which case lubricated operation will always be required)

Materials	
Housing	Brass, POM
Note on materials	RoHS-compliant

Dimensions and ordering data									
Pneumatic connection	Nominal width [mm]	B1	D1	H1	H2	Weight/ piece [g]	Part No.	Type	PU ¹⁾
PK-2	1.5	4	2.95	18	6	1	19540	Y-PK-2	10
PK-3	2.5	6.5	3.6	28.8	9.7	2	7269	Y-PK-3	10
PK-4	3.4	7.8	4.8	34.5	11.7	3	9586	Y-PK-4	10
PK-6	5.3	10.4	7	49.2	14	12	150013	Y-PK-6	10

1) Packaging unit

Barbed fittings N/CN

Technical data

FESTO

Barbed T-connector FCN

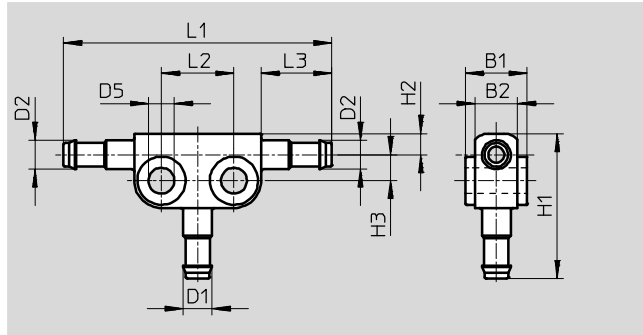

Operating and environmental conditions	
Operating pressure [bar]	-0.95 ... +10
Operating medium	Compressed air to ISO 8573-1:2010 [7:-:-]
Note on operating/pilot medium	Lubricated operation possible (in which case lubricated operation will always be required)
Ambient temperature [°C]	0 ... +60
Corrosion resistance class CRC ¹⁾	2

- 1) Corrosion resistance class CRC 2 to Festo standard FN 940070
Moderate corrosion stress. Indoor applications in which condensation may occur. External visible parts with primarily decorative requirements for the surface and which are in direct contact with the ambient atmosphere typical for industrial applications.

Materials	
Housing	Die-cast zinc
Note on materials	RoHS-compliant

Dimensions												
Pneumatic connection for tubing O.D.		B1	B2	D1	D2	D5	H1	H2	H3	L1	L2	L3
1 [mm]	2 [mm]											
3	3	6	4	2.95	2.95	3.2	15.7	3.1	2.6	28	8	6
	4	8.4	5.2	2.95	3.6	4.3	17.9	3.5	3.9	38.4	10	9.7
4	4	8.4	5.2	3.6	3.6	4.3	21.6	3.5	3.9	38.4	10	9.7
	6	10.2	7	3.6	4.8	4.3	22	3.5	4.3	44.4	12	11.7
6	6	10.2	7	4.8	4.8	4.3	24	3.5	4.3	44.4	12	11.7
	8	12	8.8	4.8	7	4.3	25.9	4.4	5.3	49.4	12	14.2
8	8	12	8.8	7	7	4.3	28.4	4.4	5.3	49.4	12	14.2

Ordering data						
Pneumatic connection for tubing O.D.		Nominal width	Weight/ piece	Part No.	Type	PU ¹⁾
1 [mm]	2 [mm]	[mm]	[g]			
3	3	1.3	5	19527	FCN-3-PK-2-B	10
	4	1.3	8	31314	FCN-3-PK-3/2	10
4	4	2	8	14768	FCN-3-PK-3	10
	6	2	12	31315	FCN-3-PK-4/3	10
6	6	2.9	12	14769	FCN-3-PK-4	10
	8	2.9	16	31316	FCN-3-PK-6/4	10
8	8	4.9	16	14770	FCN-3-PK-6	10

- 1) Packaging unit

Barbed hose fittings C-P/N-P, for hose clip

Technical data

Barbed hose fitting C-...-P

Plastic tubing is inserted and then secured with a hose clip SK.

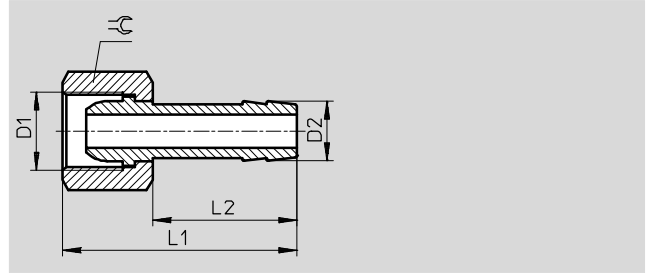

Operating and environmental conditions	
Operating medium	Compressed air to ISO 8573-1:2010 [7:-:-]
Note on operating/pilot medium	Lubricated operation possible (in which case lubricated operation will always be required)

Materials	
Housing	Brass

Dimensions and ordering data										
Pneumatic connection		Nominal width [mm]	D2	L1	L2	≡	Weight/ piece [g]	Part No.	Type	PU ¹⁾
D1										
G thread										
G ¹ / ₈	PK-6	4	7	36	24	13	18	2021	C- ¹ / ₈ -P-6	10
G ¹ / ₄	PK-6	4.5	7	39	24	17	28	2022	C- ¹ / ₄ -P-6	10
	PK-9	5.5	10	39	24	17	34	2023	C- ¹ / ₄ -P-9	10
G ³ / ₈	PK-6	4.5	7	39	24	19	31	2024	C- ³ / ₈ -P-6	1
	PK-9	6.5	10	39	24	19	34	2025	C- ³ / ₈ -P-9	1
G ¹ / ₂	PK-13	11	14.8	50	30	24	64	2026	C- ¹ / ₂ -P-13	1

1) Packaging unit

Barbed hose fittings C-P/N-P, for hose clip

Technical data

FESTO

Barbed hose fitting N-...-P

Aluminium design

Plastic tubing is inserted and then secured with a hose clip SK.

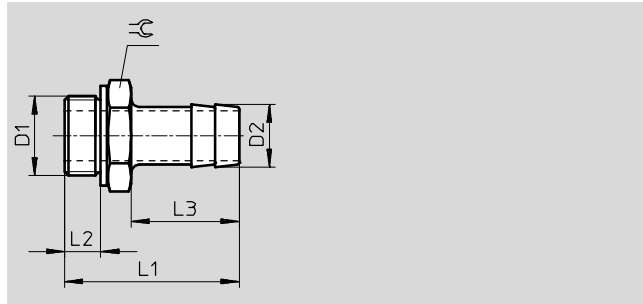

General technical data	
Type of seal on threaded plug	Sealing ring OK (G thread only)

Operating and environmental conditions	
Operating pressure for entire temperature range [bar]	-0.95 ... +16
Operating medium	Compressed air to ISO 8573-1:2010 [7:-:-]
Note on operating/pilot medium	Lubricated operation possible (in which case lubricated operation will always be required)
Corrosion resistance class CRC ¹⁾	2

1) Corrosion resistance class CRC 2 to Festo standard FN 940070
Moderate corrosion stress. Indoor applications in which condensation may occur. External visible parts with primarily decorative requirements for the surface and which are in direct contact with the ambient atmosphere typical for industrial applications.

Materials	
Housing	Blue anodised aluminium
Note on materials	RoHS-compliant

Dimensions and ordering data										
Pneumatic connection		Nominal width	D2	L1	L2	L3	≈	Part No.	Type	PU ¹⁾
D1		[mm]								
G thread with sealing ring										
G ¹ / ₈	PK-6	4.5	7	34.7	4.9	24.2	13	3605	N- ¹ / ₈ -P-6	10
G ¹ / ₄	PK-6	4.5	7	37.1	5.8	24.1	17	3606	N- ¹ / ₄ -P-6	10
	PK-9	6.5	10	37.1	5.8	24.1	17	3607	N- ¹ / ₄ -P-9	10
G ³ / ₈	PK-6	4.5	7	38.1	6.8	24.1	19	3608	N- ³ / ₈ -P-6	10
	PK-9	7.6	10	38.1	6.8	24.1	19	3609	N- ³ / ₈ -P-9	10
	PK-13	11	14.8	45.4	6.8	30	19	36160	N- ³ / ₈ -P-13	1
G ¹ / ₂	PK-9	8	10.3	39.5	8.15	24	24	3610	N- ¹ / ₂ -P-9	1
	PK-13	11	14.8	45.5	8.15	30	24	3611	N- ¹ / ₂ -P-13	1
G ³ / ₄	PK-13	11	14.8	50	9.05	30	32	3612	N- ³ / ₄ -P-13	1
	PK-19	16.5	20.8	56	9.05	36	32	3613	N- ³ / ₄ -P-19	1
R thread										
R1	PK-19	16.5	20.8	68.6	-	36	34	572260	N-1-P-19	1
NPT thread										
NPT ³ / ₄ -14	PK-19	16.5	20.8	66.68	-	36	30.17	564848	N- ³ / ₄ -P-19-NPT	1
NPT1-11 ¹ / ₂	PK-19	16.5	20.8	74.0	-	36	34	572243	N-1-P-19-NPT	1

1) Packaging unit

Barbed hose fittings C-P/N-P, for hose clip

Technical data

Barbed hose fitting N-...-P-...-MS

Brass design

Plastic tubing is inserted and then secured with a hose clip.

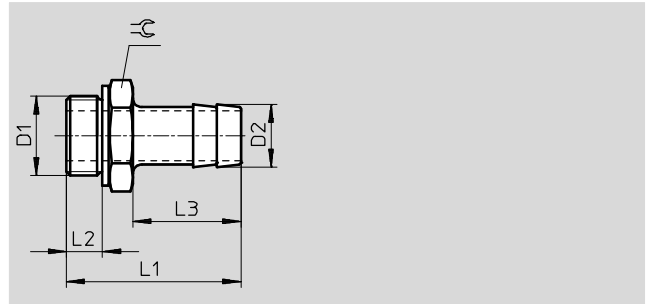

General technical data	
Type of seal on threaded plug	Sealing ring OK

Operating and environmental conditions	
Operating pressure for entire temperature range [bar]	-0.95 ... +16
Operating medium	Compressed air to ISO 8573-1:2010 [7:-:-]
Note on operating/pilot medium	Lubricated operation possible (in which case lubricated operation will always be required)
Corrosion resistance class CRC ¹⁾	1

1) Corrosion resistance class CRC 1 to Festo standard FN 940070
 Low corrosion stress. For dry indoor applications or transport and storage protection. Also applies to parts behind covers, in the non-visible interior area, and parts which are covered in the application (e.g. drive trunnions).

Materials	
Housing	Brass
Note on materials	RoHS-compliant

Dimensions and ordering data										
Pneumatic connection		Nominal width [mm]	D2	L1	L2	L3	⌀	Part No.	Type	PU ¹⁾
D1										
G thread with sealing ring										
G1/8	PK-6	4.5	7	34.7	4.9	24.2	13	15630	N-1/8-P-6-MS	10
G1/4	PK-6	4.5	7	37.1	5.8	24.1	17	15631	N-1/4-P-6-MS	10
	PK-9	6.5	10	37.1	5.8	24.1	17	15632	N-1/4-P-9-MS	10
G3/8	PK-6	4.5	7	38.1	6.8	24.1	19	15633	N-3/8-P-6-MS	10
	PK-9	7.6	10	38.1	6.8	24.1	19	15634	N-3/8-P-9-MS	10
	PK-13	11	14.8	45.4	6.8	30	19	36161	N-3/8-P-13-MS	1
G1/2	PK-9	8	10.3	39.5	8.15	24	24	15635	N-1/2-P-9-MS	1
	PK-13	11	14.8	45.5	8.15	30	24	15636	N-1/2-P-13-MS	1
G3/4	PK-13	11	14.8	50	9.05	30	32	15637	N-3/4-P-13-MS	1
	PK-19	16.5	20.8	56	9.05	36	32	15638	N-3/4-P-19-MS	1

1) Packaging unit

Hose clip SK

Technical data

Hose clip SK
to DIN 3017

The hose clips are equipped with a worm thread. 9 mm band width.



Materials	
Housing	Steel

Ordering data				
Clamping range \varnothing [mm]	Weight/ piece [g]	Part No.	Type	PU ¹⁾
8 ... 16	7	9274	SK-8-16	10
16 ... 27	12	9275	SK-16-27	10
20 ... 32	13	9276	SK-20-32	10

1) Packaging unit