

Fieldbus modules CTEU/Installation system CTEL



Fieldbus modules CTEU/Installation system CTEL

Key features

FESTO



The system

- CTEU fieldbus modules for valve terminals
- Festo-specific interface (I-Port)
- Input modules CTSL for detecting sensor signals
- Connection for the installation system CPI from Festo
- Direct and easy networking of valve terminals and other devices via a bus connection

- Wide range of applications thanks to high degree of protection to IP65/67
- Universal connection technology (Sub-D, M12, terminal strip)
- Optional decentralised installation of bus node for connecting two valve terminals
- Basic diagnostics: undervoltage, short circuit

CTEU for the universal use of valve terminals. The Festo-specific, uniformly defined interface (I-Port) enables the fieldbus modules to be used for different types of valve terminal.

The following protocols are currently supported:

- CANopen
- DeviceNet
- CC-LINK
- PROFIBUS
- EtherCAT
- AS-Interface
- PROFINET
- EtherNet/IP

Valve terminal configurator

A valve terminal configurator is available online to help you select a suitable valve terminal. Select the valve terminal with I-Port interface and order the associated CTEU bus nodes. The bus nodes then

only need to be placed on the valve terminal. The ident. code for the valve terminals specifies the valve functions, the number of valves and unused valve positions, as well as the additional

functions and the type of compressed air supply.

As is the case with all Festo products, all valve terminals are supplied:

- Fully preassembled
- Equipped with fittings on request

Online via: → www.festo.com

- Tested for electrical function
- Tested for pneumatic function
- Securely packaged
- User documentation can be downloaded free of charge

Fieldbus modules CTEU/Installation system CTEL

Key features

Fieldbus systems with CTEU



CANopen

CANopen was originally developed for the automotive industry by a joint venture led by Bosch. It has been maintained by the organisation CiA (CAN in Automation) since 1995, and at the end of 2002 it was standardised as European standard EN 50325-4.



DeviceNet

DeviceNet is an open fieldbus standard that was developed by Rockwell Automation on the basis of the CAN protocol. DeviceNet is standardised in European standard EN 50325.



CC-Link

“Control and Communications Link” (CC-Link) was developed by Mitsubishi Electric and has been available as an open fieldbus network since 1999.



PROFIBUS

Process Fieldbus (PROFIBUS) is a fieldbus that was developed by Siemens and has been standardised in the IEC 61158 series of international standards. It enables communication between devices without the need for any specific adaptations to the interface.



EtherCAT

EtherCAT is a bus with real-time capability; it was developed by Beckhoff and the EtherCAT Technology Group (ETG). EtherCAT is an open technology and has been standardised in international standards IEC 61158 and IEC 61784 and in ISO 15745-4.



AS-Interface

AS-Interface is a manufacturer-independent, easy and robust installation system. It was developed and represented by the AS-International Association, a loose association of diverse companies from different sectors. AS-Interface has been standardised by IEC 62026-2 and EN 50295.



PROFINET

PROFINET by PROFIBUS and PROFINET International (PI) is the open industrial Ethernet standard for automation and is based on Ethernet TCP/IP and IT standards. PROFINET technology is developed by Siemens and the PROFIBUS user organisation. PROFINET is standardised in IEC 61158 and IEC 61784.



EtherNet/IP

EtherNet/IP was developed by Allen-Bradley (Rockwell Automation) and the ODVA (Open DeviceNet Vendor Association). EtherNet/IP is an open standard (technology based on Ethernet TCP/IP and UDP/IP) for industrial networks and is standardised in the IEC 61158 series of international standards.

Fieldbus modules CTEU/Installation system CTCL

Key features



Integration of the I-Port interface/IO-Link

Different bus nodes are used for integration in the control systems of various manufacturers.

The following protocols are supported with the compatible bus node CTEU:

- CANopen
- DeviceNet
- EtherCAT
- CC-LINK
- PROFIBUS
- AS-Interface
- PROFINET
- EtherNet/IP

A second valve terminal can be connected via a connecting plate (decentralised adapter). (→p.6)

System overview, example

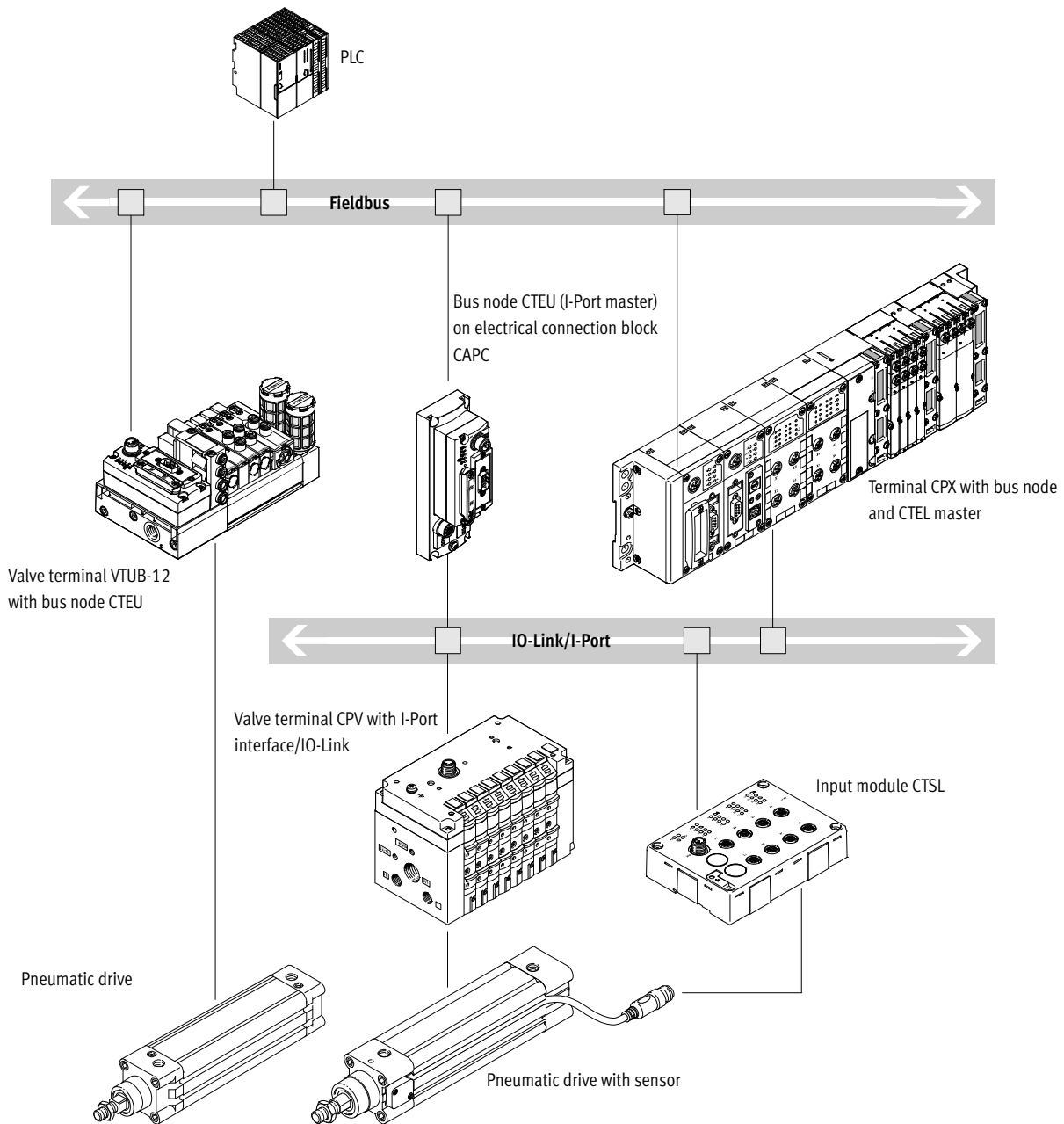

- Communication with the higher-order controller via fieldbus
- Use a bus node CTEU compatible with the fieldbus protocol
- Up to 64 inputs/outputs (solenoid coils), depending on the valve terminal

Fieldbus modules CTEU/Installation system CTEL

Key features

System overview

Example CTEU-AS interface

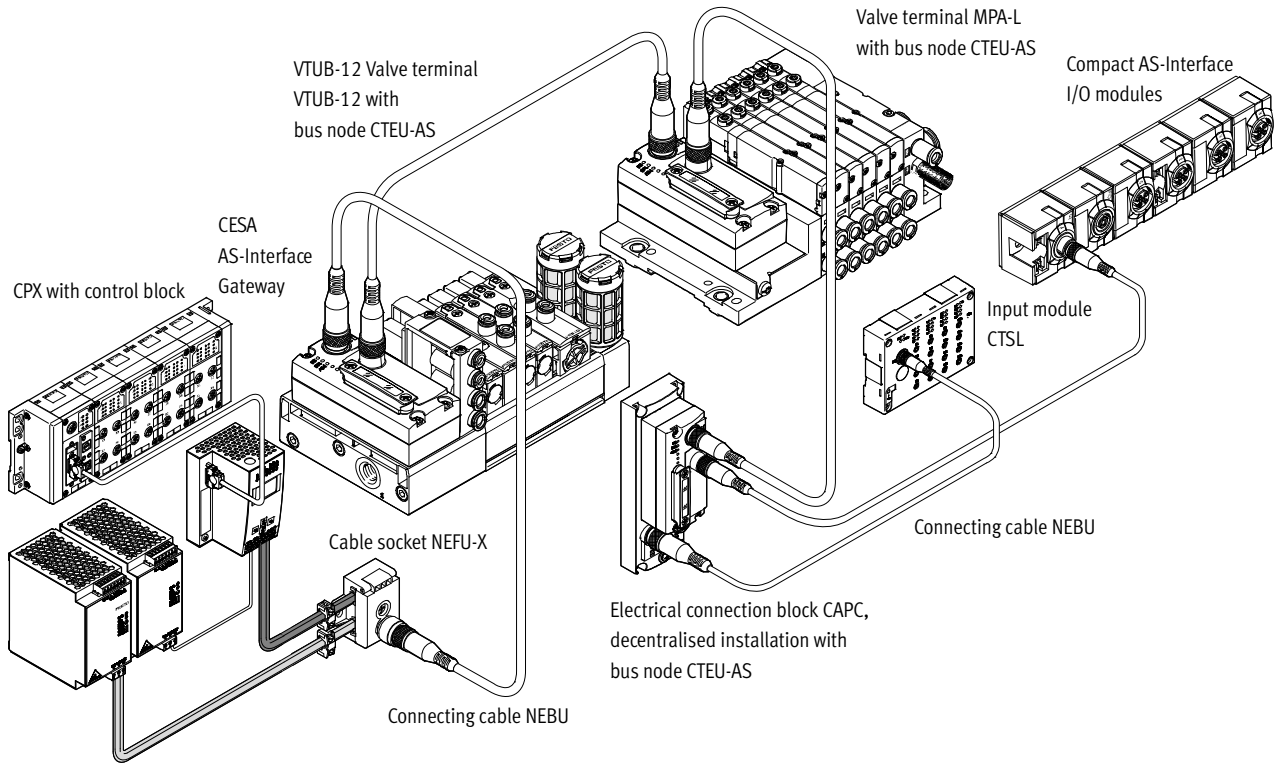

Power supply unit CACN for AS-Interface systems

Fieldbus modules CTEU/Installation system CTEL

Peripherals overview

Overview of CTEU with valve terminal VTUG

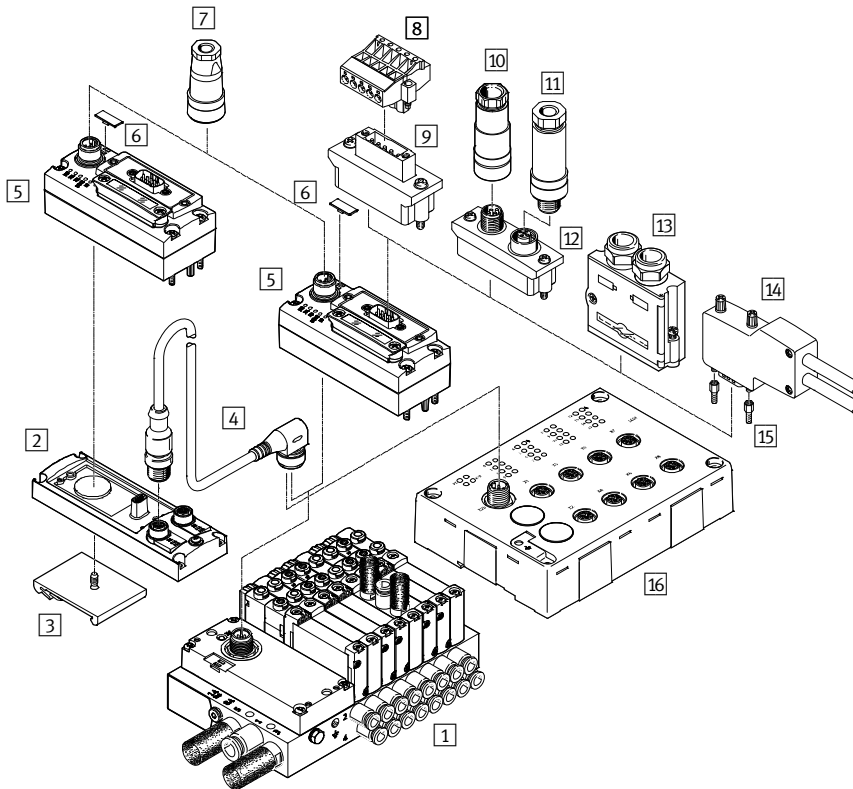

Accessories				
	Type	Brief description	→ Page/Internet	
1	Manifold rail	VABM	With I-Port interface, for connecting max. 35 valves	vtug
2	Electrical connection block	CAPC	For connecting a further terminal (2x I-Port interface)	13
3	H-rail adapter	CAFM	For electrical connection block CAPC	13
4	Connecting cable	NEBU	For IO-Link	11, 13
5	Bus node	CTEU	-	15, 19, 25, 29, 34, 38, 41, 45, 49
6	Inscription label	ASLR	For bus node	aslr
7	Power supply socket	NTSD/FBSD	For power supply	18, 23, 28, 33, 37
8	Terminal strip	FBSD-KL	For Open Style connection	18, 23
9	Bus connection	FBA-1	Open Style for 5-pin terminal strip	18, 23
10	Fieldbus socket	FBSD-GD, NECU	For Micro Style connection, M12, 5-pin	18, 23, 33
11	Plug connector	FBS, NECU	For Micro Style connection, M12, 5-pin	18, 23, 33
12	Bus connection	FBA-2	Micro Style, 2xM12, 5-pin	18, 23, 33
13	Plug connector	FBS-SUB-9-BU	Sub-D	18, 23, 33
14	Plug connector	FBS-SUB-9-WS	Sub-D, angled	18, 33
15	Threaded sleeve	UNC	Sub-D mounting bolts	18, 23, 28, 33
16	Input module	CTSL-D-16E	-	73

Fieldbus modules CTEU/Installation system CTEL

Key features – Diagnostics

System diagnostics CTEU

Diagnostics LED on the bus node CTEU

The fieldbus-specific LEDs indicate the communication status and the fieldbus function.

A further LED indicates the status of the power supply:

- Undervoltage/short circuit
- Power supply ensured
- Interruption of voltage

Diagnostic messages via the fieldbus

- Configuration error
- Short circuit/overload of an output module
- Short circuit/undervoltage
- Undervoltage/load voltage of the valves

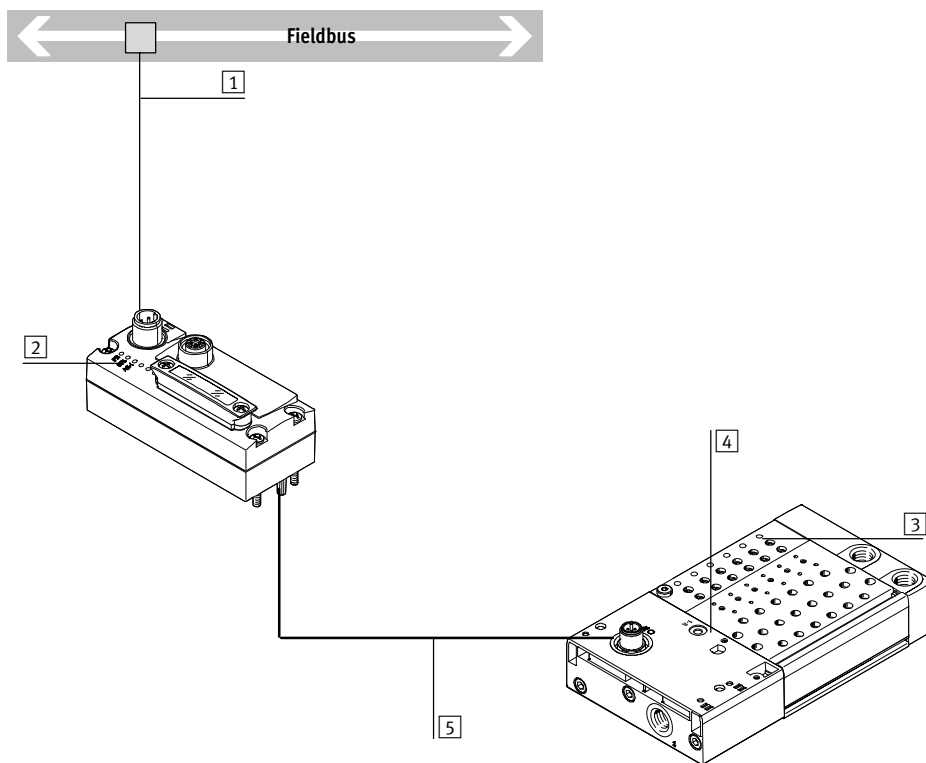

- 1 Diagnostics via fieldbus
- 2 Bus-specific LEDs
- 3 Switching status display using LEDs (one per valve on the manifold rail)
- 4 Additional communication and voltage status LED for decentralised installation
- 5 I-Port interface to the fieldbus module

Fieldbus modules CTEU/Installation system CTEL

Key features – Power supply



Operating voltage and load current supply

The operating voltages for the valve terminal with I-Port interface are centrally connected to the bus node via a 5-pin M12 plug connector.

The operating voltages are required for the bus node electronics and the load supply to the valves (supplied separately from the electronics supply).

The power supplies do not have a common 0V line and are thus completely galvanically isolated from one another.

Example power supply concept CTEU with valve terminal VTUG

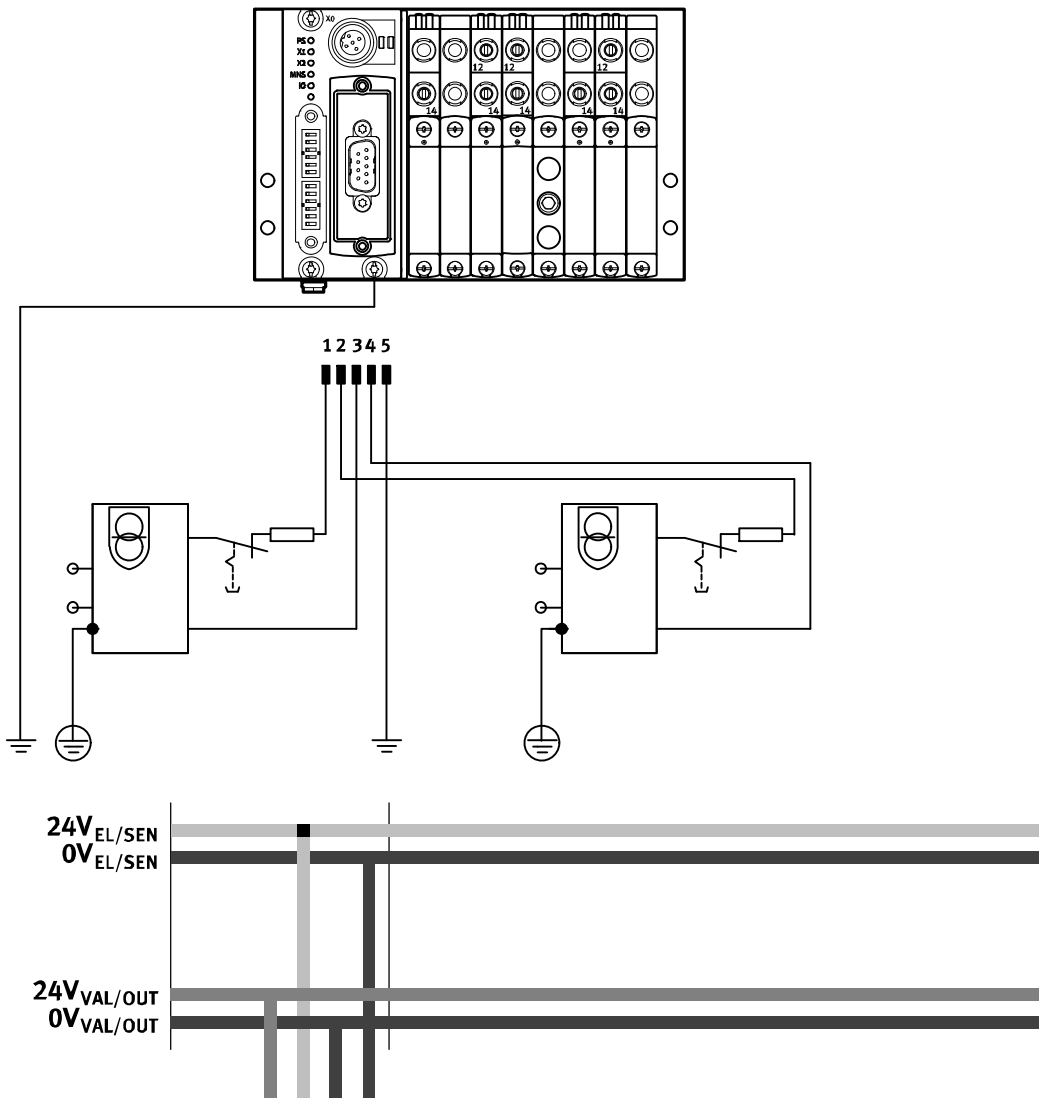

Fieldbus modules CTEU/Installation system CTEL

Key features – Power supply

Power supply concept

Example power supply concept CTEU with electrical connection block (decentralised adapter) CAPC and valve terminal VTUG

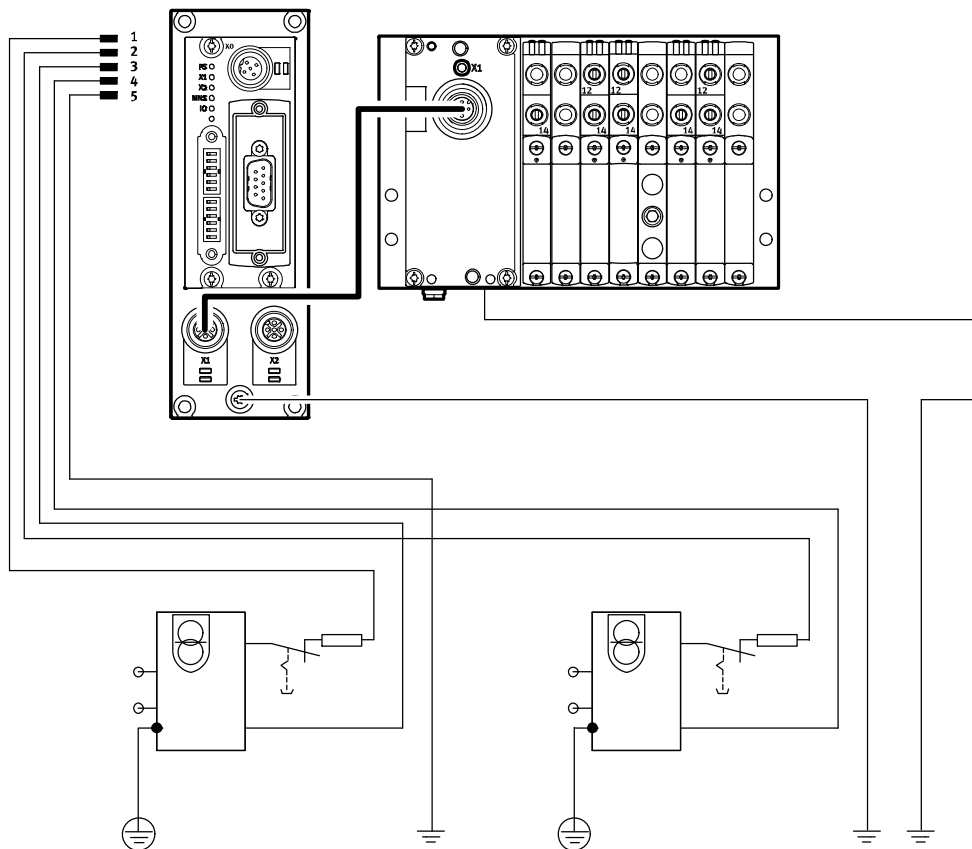

Fieldbus modules CTEU/Installation system CTCL

Technical data – I-Port interface/IO-Link for valve terminal VTUG



Festo-specific, standardised interface for direct connection to the fieldbus by mounting the bus node CTEU or to an IO-Link master via a cable (in IO-Link mode).

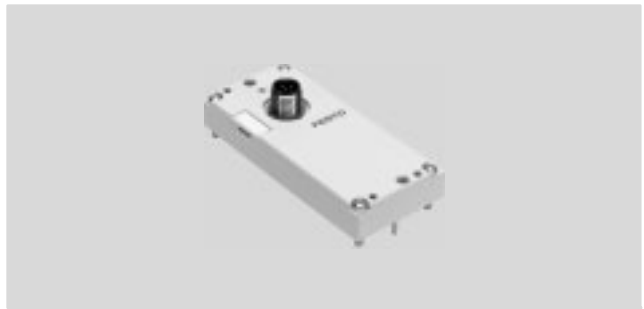

I-Port interface/IO-Link

Versions:

- I-Port interface for bus nodes (CTEU)
- IO-Link mode for direct connection to a higher-order IO-Link master

The electrical supply/transmission of communication takes place via an M12 plug connector.

General technical data			
Communication types			IO-Link
Electrical connection			<ul style="list-style-type: none"> • M12 plug connector, 5-pin • A-coded • Metal thread for screening
Baud rates	COM3	[kbps]	230.4
	COM2	[kbps]	38.4
Intrinsic current consumption, logic supply PS		[mA]	30
Intrinsic current consumption, valve supply PL		[mA]	30
Max. number of solenoid coils	VAEM-L1-S-8-PT		16
	VAEM-L1-S-16-PT		32
	VAEM-L1-S-24-PT		48
Max. no. of valve positions	VAEM-L1-S-8-PT		8
	VAEM-L1-S-16-PT		16
	VAEM-L1-S-24-PT		24
Ambient temperature		[°C]	-5 ... +50
Degree of protection to EN 60529			IP67

LED display			
Status LED X1	Colour	Status	Function
Status LED X1	Red/green	Off	No 24 V logic
	2	Status green	Everything OK
	3	Flashing green	Communication error (in the I-Port or IO-Link protocol)
	4	Flashing red/green	Load supply error (undervoltage or no load supply)
	5	Static red	Load supply error and communication error

Pin allocation I-Port interface/IO-Link			
	Pin	Allocation	Description
	1	24V _{EL} /SEN	Operating voltage supply (electronics, sensors/inputs)
	2	24V _{VAL} /OUT	Load voltage supply (valves/outputs)
	3	0V _{EL} /SEN	Operating voltage supply (electronics, sensors/inputs)
	4	C/Q	Data communication
	5	0V _{VAL} /OUT	Load voltage supply (valves/outputs)

Fieldbus modules CTEU/Installation system CTEL

Technical data – I-Port interface/IO-Link for valve terminal VTUG

Dimensions Download CAD data → www.festo.com

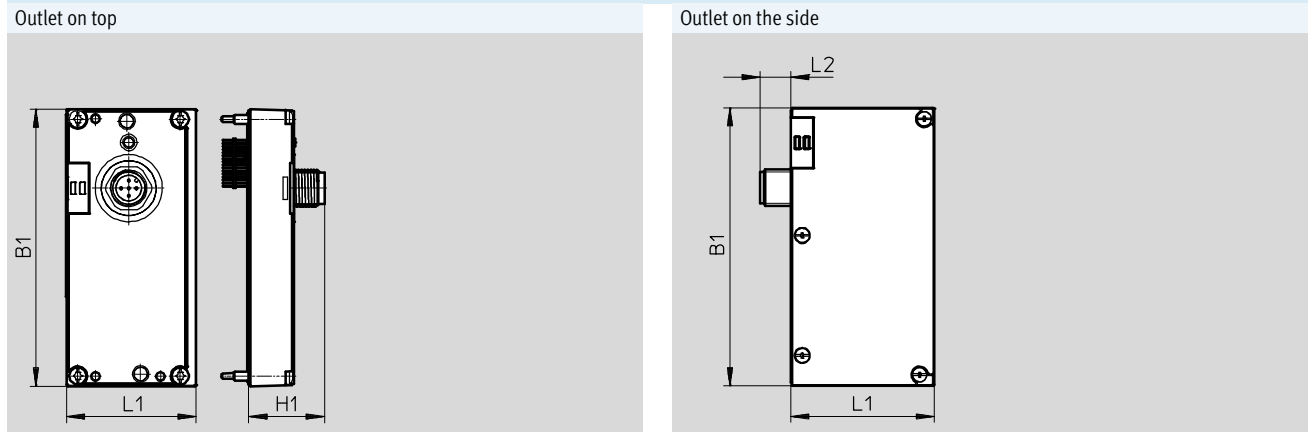

Type	Outlet on top			Outlet on the side		
	B1	L1	H1	B1	L1	L2
VAEM-L1-S-...	91	47.1	25	91.5	47.1	10

Accessories – I-Port interface/IO-Link

	Description	Part No.	Type		
Electrical interface for I-Port interface/IO-Link, outlet on top					
	Actuation of up to 8 double solenoid valve positions	573384	VAEM-L1-S-8-PT		
	Actuation of up to 16 double solenoid valve positions	573939	VAEM-L1-S-16-PT		
	Actuation of up to 24 double solenoid valve positions	573940	VAEM-L1-S-24-PT		
Electrical interface for I-Port interface/IO-Link, outlet on the side					
	Actuation of up to 8 double solenoid valve positions	574207	VAEM-L1-S-8-PTL		
	Actuation of up to 16 double solenoid valve positions	574208	VAEM-L1-S-16-PTL		
	Actuation of up to 24 double solenoid valve positions	574209	VAEM-L1-S-24-PTL		
Connection technology for I/O-Link					
	T-adapter M12, 5-pin for IO-Link and load supply	171175	FB-TA-M12-5POL		
Straight plug connector, for I-Port/IO-Link					
	Straight plug connector, M12, 5-pin (in combination with adapter for separate load supply)	175487	SEA-M12-5GS-PG7		
Inscription label for I-Port/IO-Link					
	40 pieces in frame	565306	ASLR-C-E4		
Connecting cable					
	Straight - angled	Suitable for use with energy chains	5 m	574321	NEBU-M12G5-E-5-Q8N-M12G5
			7.5 m	574322	NEBU-M12G5-E-7.5-Q8N-M12G5
			10 m	574323	NEBU-M12G5-E-10-Q8N-M12G5
	Angled - angled	Standard	0.5 m	570733	NEBU-M12W5-K-0.5-M12W5
				8003617	NEBU-M12G5-K-0.5-M12W5
			2 m	570734	NEBU-M12W5-K-2-M12W5
				8003618	NEBU-M12G5-K-2-M12W5

Fieldbus modules CTEU/Installation system CTEL

Technical data – Electrical connection block CAPC

Function

The electrical connection block CAPC enables decentralised installation of bus nodes CTEU on a valve terminal or input modules with I-Port interface.

Scope of application

- M12 connection technology (two interfaces)
- Enables the installation of valve terminals or other devices over a distance of 20 metres
- By using the accessory CAFM the electrical connection block can be installed on an H-rail



General technical data		
Type		CAPC-F1-E-M12
Dimensions W x L x H	[mm]	50x148x28
Fieldbus interface		2 x M12 socket, 5-pin, A-coded
Operating voltage range	[V DC]	18 ... 30
Max. power supply	[A]	2
Nominal operating voltage	[V DC]	24
Product weight	[g]	85
Cable length	[m]	20

Materials	
Housing	PA reinforced
Note on materials	RoHS compliant

Operating and environmental conditions	
Degree of protection to EN 60529	IP65, IP67
Ambient temperature	[°C] -5 ... +50
Storage temperature	[°C] -20 ... +70
Corrosion resistance class CRC	2 ¹⁾
CE marking (see declaration of conformity)	To EU EMC Directive ²⁾

- 1) Corrosion resistance class 2 according to Festo standard 940 070
Components subject to moderate corrosion stress. External visible parts with primarily decorative surface requirements which are in direct contact with the surrounding industrial environment or media such as coolants or lubricating agents.
- 2) For information about the applicability of the component see the manufacturer's EC declaration of conformity at: www.festo.com/sp → Certificates.
If the component is subject to restrictions on usage in residential, office or commercial environments or small businesses, further measures to reduce the emitted interference may be necessary.

Fieldbus modules CTEU/Installation system CTEL

Technical data – Electrical connection block CAPC

Dimensions Download CAD data → www.festo.com

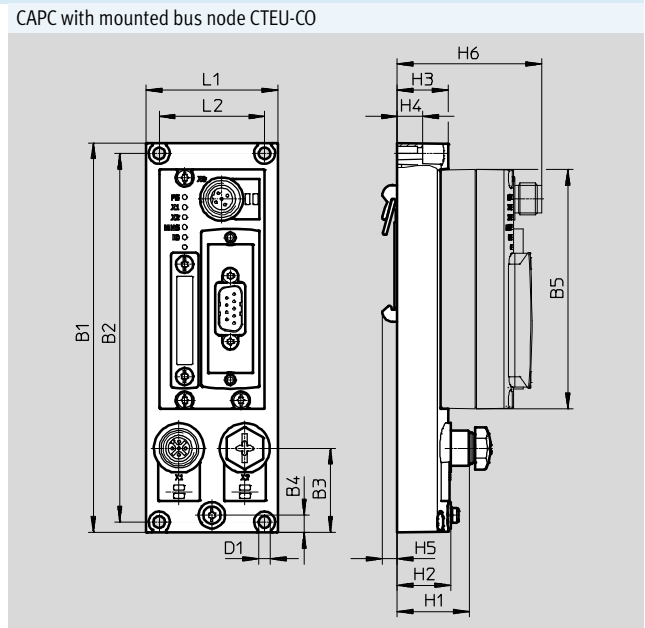
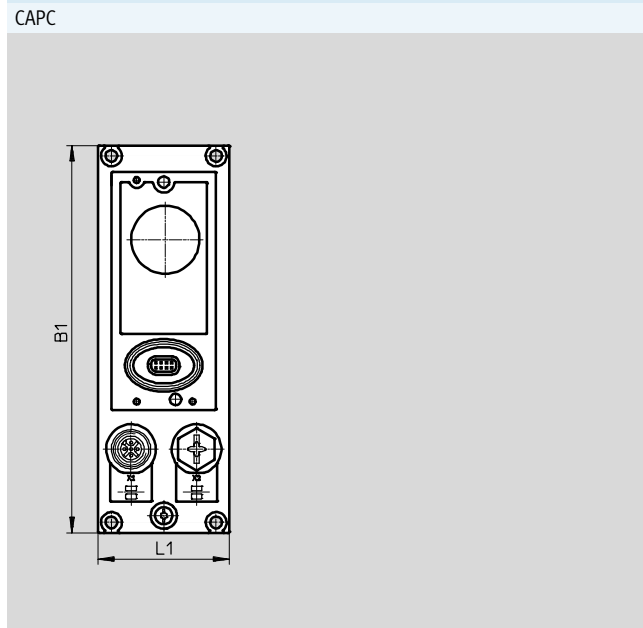

Type	B1	B2	B3	B4	B5	D1-∅	H1	H2	H3	H4	H5	H6	L1	L2
CAPC	148	140	32	6.6	91	4.4	27.3	20.3	19.3	9.6	5.7	54.8	50	40

Pin allocation I-Port interface/IO-Link			
	Pin	Allocation	Description
	1	24V _{EL} /SEN	Operating voltage supply (electronics, sensors/inputs)
	2	24V _{VAL} /OUT	Load voltage supply (valves/outputs)
	3	0V _{EL} /SEN	Operating voltage supply (electronics, sensors/inputs)
	4	C/Q	Data communication
	5	0V _{VAL} /OUT	Load voltage supply (valves/outputs)
	Housing, FE		Functional earth

Accessory CAPC				
	Description	Part No.	Type	
Electrical connection block				
	-	570042	CAPC-F1-E-M12	
H-rail mounting				
	-	570043	CAFM-F1-H	
Connecting cable				
	Straight - angled	Suitable for use with energy chains	5	574321 NEBU-M12G5-E-5-Q8N-M12G5
			7.5	574322 NEBU-M12G5-E-7.5-Q8N-M12G5
			10	574323 NEBU-M12G5-E-10-Q8N-M12G5
	Angled - angled	Standard	0.5 m	570733 NEBU-M12W5-K-0.5-M12W5
				8003617 NEBU-M12G5-K-0.5-M12W5
				570734 NEBU-M12W5-K-2-M12W5
Straight - angled		2 m	8003618 NEBU-M12G5-K-2-M12W5	

Fieldbus modules CTEU/Installation system CTEL

Technical data – CTEU-CO

FESTO



The bus node handles communication between the valve terminal and a higher-level CANopen® master.

The module has basic diagnostic functions. It has 5 integrated LEDs for on-site display. A maximum of 8 byte inputs and 8 byte outputs are transmitted in the cyclic process image.



Application

Fieldbus connection

The bus connection is established via a 9-pin Sub-D plug connector (pin) as per the CAN in Automation (CiA) specification DS 102 with additional 24 V CAN transceiver supply (option as per DS 102).

The bus connector plug (with IP65/IP67 degree of protection from Festo or IP20 degree of protection from other manufacturers) facilitates the connection of an incoming and an outgoing bus cable.

There are 4 contacts each available for the conductors (CAN_L/CAN_H and 24 V/0 V optional) of the incoming and outgoing bus cables.

The fieldbus parameters and the basic device parameter settings are set on the bus node via DIL switches.

Implementation

Protocol chip used:

- CAN transceiver 82C251

Possible transmission rate:

- 125 kbps
- 250 kbps
- 500 kbps
- 1 Mbps

Max. CANopen cable length (trunk cable):

- 40 m at 1 Mbps
- 100 m at 500 kbps
- 250 m at 250 kbps
- 500 m at 125 kbps

Max. branch cable length (drop cable):

- 0.30 m at 1 Mbps
- 0.75 m at 500 kbps
- 2.00 m at 250 kbps
- 3.75 m at 125 kbps

The following variants can be realised using an adapter:

- 2 x Micro Style M12, degree of protection IP65, 5-pin, plug connector and socket
- Open Style plug connector, degree of protection IP20, 5-pin, pin

Fieldbus modules CTEU/Installation system CTEL

Technical data – CTEU-CO

General technical data			
Fieldbus interface			<ul style="list-style-type: none"> • Sub-D socket, 9-pin • Sub-D plug connector, for self-assembly • 2x M12x1, 5-pin • 5-pin terminal strip
Protocol			CANopen
Baud rates		[kbps]	125, 250, 500 and 1000
Internal cycle time			1 ms per 1 byte of user data
Operating voltage		Nominal value	[V DC] 24
		Permissible range	[V DC] 18 ... 30
Intrinsic current consumption at nominal operating voltage		[mA]	Typically 65
Max. power supply		[A]	4
Parameterisation			Diagnostic behaviour Fail state
Max. address capacity, inputs			8 bytes
Max. address capacity, outputs			8 bytes
Additional functions			<ul style="list-style-type: none"> • Emergency message • Acyclic data access via "SDO"
Control elements			DIL switches
Configuration support			EDS files
Device-specific diagnostics			<ul style="list-style-type: none"> • System diagnostics • Undervoltage • Communication error
LED display		Fieldbus-specific	<ul style="list-style-type: none"> • MNS: Network status • IO: I/O status
		Product-specific	<ul style="list-style-type: none"> • PS: Operating voltage for electronics and load supply • X1: System status of module at I-Port 1 • X2: System status of module at I-Port 2
Degree of protection to EN 60529			IP65/IP67
Note on materials			RoHS compliant
Information on materials - housing			<ul style="list-style-type: none"> • PC • PA reinforced
Product weight		[g]	90
Temperature range		Environment	[°C] -5 ... +50
		Storage	[°C] -20 ... +70
Dimensions W x L x H		[mm]	40 x 91 x 50
Corrosion resistance class CRC			2 ¹⁾
CE marking			To EU EMC Directive ²⁾
Approval certificate			RCM mark c UL us - Recognized (OL)

1) Corrosion resistance class 2 to Festo standard 940 070

Components subject to moderate corrosion stress. External visible parts with primarily decorative surface requirements which are in direct contact with the surrounding industrial environment or media such as coolants or lubricating agents.

2) For information about the applicability of the component see the manufacturer's EC declaration of conformity at: www.festo.com/sp → Certificates.

If the component is subject to restrictions on usage in residential, office or commercial environments or small businesses, further measures to reduce the emitted interference may be necessary.

Fieldbus modules CTEU/Installation system CTEL

Technical data – CTEU-CO

Dimensions

Download CAD data → www.festo.com

CTEU-CO

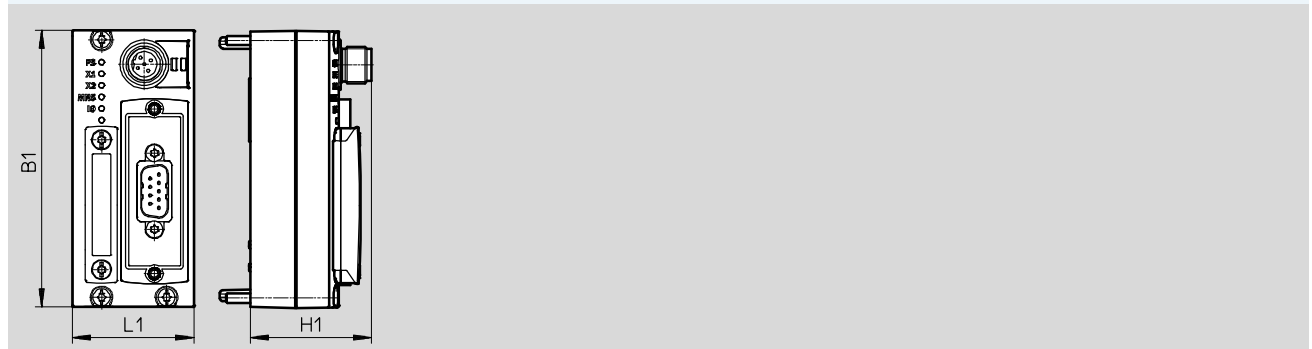

Type	B1	H1	L1
CTEU-CO	91	39.8	40

Pin allocation

	Pin	Allocation	Description
Sub-D, 9-pin, CANopen interface			
	1	n.c.	Not connected
	2	CAN_L	Received/transmitted data low
	3	CAN_GND	0 V CAN interface (connected to pin 6)
	4	n.c.	Not connected
	5	CAN_SHLD	Optional screened connection
	6	GND	0 V CAN interface, optional (connected to pin 3)
	7	CAN_H	Received/transmitted data high
	8	n.c.	Not connected
	9	CAN_V+	24 V DC supply CAN interface
	Housing		
Power supply, M12, B-coded			
	1	24V _{EL} /SEN	Operating voltage supply (electronics, sensors/inputs)
	2	24V _{VAL} /OUT	Load voltage supply (valves/outputs)
	3	0V _{EL} /SEN	Operating voltage supply (electronics, sensors/inputs)
	4	0V _{VAL} /OUT	Load voltage supply (valves/outputs)
	5	FE	Functional earth

Fieldbus modules CTEU/Installation system CTEL

Technical data – CTEU-CO







Pin allocation of the CANopen interface			
Fieldbus plug connector/adapter	Pin	Allocation	Description
Bus connection, FBA-2-M12-5POL			
	1	FE	Functional earth
	2	CAN_V+	24 V DC supply CAN interface
	3	CAN_GND	0 V CAN interface
	4	CAN_H	Received/transmitted data high
	5	CAN_L	Received/transmitted data low
Bus connection, FBA-1-SL-5POL with FBSD-KL-2X5POL			
	1	CAN_GND	0 V CAN interface
	2	CAN_L	Received/transmitted data low
	3	FE	Functional earth
	4	CAN_H	Received/transmitted data high
	5	CAN_V+	24 V DC supply CAN interface

Connection and display components	
	<ol style="list-style-type: none"> 1 Status LED (operating status/diagnostics) 2 DIL switch 3 Power supply for bus node and connected devices (valve terminal) 4 Fieldbus connection (Sub-D plug connector)

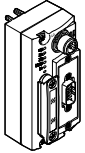
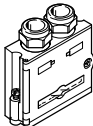
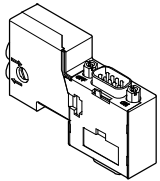
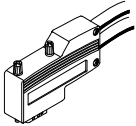
Fieldbus modules CTEU/Installation system CTEL

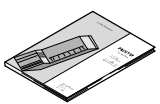

Accessories – CTEU-CO

Ordering data		Part No.	Type
Bus node			
	CANopen bus node	570038	CTEU-CO
Bus connection			
	Sub-D plug connector, straight	532219	FBS-SUB-9-BU-2x5POL-B
	Sub-D socket for CANopen with terminating resistor and programming interface	574588	NECU-S1W9-C2-ACO
	Sub-D plug connector, angled	533783	FBS-SUB-9-WS-CO-K
	Micro Style bus connection, 2xM12, 5-pin, A-coded	525632	FBA-2-M12-5POL
	Socket for micro style connection, A-coded	18324	FBSD-GD-9-5POL
	Plug connector for Micro Style connection, M12, 5-pin, A-coded	175380	FBS-M12-5GS-PG9
	Open Style bus connection	525634	FBA-1-SL-5POL
	Terminal strip for Open Style connection, 5-pin	525635	FBSD-KL-2x5POL
Fitting			
	Threaded sleeve for Sub-D	533000	UNC4-40/M3X8
Plug socket			
	For power supply	538999	NTSD-GD-9-M12-5POL-RK
User documentation			
	User documentation – bus node CTEU-CO	German	573767 P.BE-CTEU-CO-OP+MAINT-DE
		English	573768 P.BE-CTEU-CO-OP+MAINT-EN
		Spanish	573769 P.BE-CTEU-CO-OP+MAINT-ES
		French	573770 P.BE-CTEU-CO-OP+MAINT-FR
		Italian	573771 P.BE-CTEU-CO-OP+MAINT-IT
		Chinese	573772 P.BE-CTEU-CO-OP+MAINT-ZH

Fieldbus modules CTEU/Installation system CTEL

Technical data – CTEU-DN



The bus node handles communication between the valve terminal and a higher-order DeviceNet® master.

The module has basic diagnostic functions. It has 5 integrated LEDs for on-site display. Up to 8 byte inputs and 8 byte outputs are typically transmitted in the cyclic process image.



Application

Fieldbus connection

The bus connection is established via a 9-pin Sub-D socket with a typical allocation (to EN 50170).

The bus connector plug (with degree of protection IP65/IP67 from Festo or IP20 from other manufacturers) facilitates the connection of an

incoming and an outgoing bus cable. The fieldbus parameters and the basic device parameter settings are

set on the bus node via DIL switches.

Implementation

Protocol chip used:

- CAN transceiver 82C251

Possible transmission rate:

- 125 kbps
- 250 kbps
- 500 kbps

Max. DeviceNet cable length (trunk cable):

- 100 m at 500 kbps
- 250 m at 250 kbps
- 500 m at 125 kbps

Max. branch cable length (drop cable):

- 6 m at 500 kbps
- 6 m at 250 kbps
- 6 m at 125 kbps

The following variants can be realised using an adapter:

- 2 x Micro Style M12, degree of protection IP65, 5-pin, plug connector and socket
- Open Style plug connector, degree of protection IP20, 5-pin, pin

Fieldbus modules CTEU/Installation system CTEL

Technical data – CTEU-DN

General technical data			
Fieldbus interface		<ul style="list-style-type: none"> • Sub-D socket, 9-pin • Sub-D plug connector, for self-assembly • 2x M12x1, 5-pin • 5-pin terminal strip 	
Protocol		DeviceNet	
Baud rates	[kbps]	125, 250, 500	
Internal cycle time		1 ms per 1 byte of user data	
Operating voltage	Nominal value	[V DC]	24
	Permissible range	[V DC]	18 ... 30
Intrinsic current consumption at nominal operating voltage		[mA]	Typically 65
Max. power supply		[A]	4
Parameterisation		Diagnostic behaviour Fail-safe and idle response	
Max. address capacity, inputs		8 bytes	
Max. address capacity, outputs		8 bytes	
Additional functions		<ul style="list-style-type: none"> • Acyclic data access via "Explicit Message" • Quick connect • System status can be displayed using process data 	
Control elements		DIL switches	
Configuration support		EDS files	
Device-specific diagnostics		<ul style="list-style-type: none"> • System diagnostics • Undervoltage • Communication error 	
LED display	Fieldbus-specific		<ul style="list-style-type: none"> • MNS: Network status • IO: I/O status
	Product-specific		<ul style="list-style-type: none"> • PS: Operating voltage for electronics and load supply • X1: System status of module at I-Port 1 • X2: System status of module at I-Port 2
Degree of protection to EN 60529		IP 65/IP 67	
Note on materials		RoHS compliant	
Information on materials - housing		<ul style="list-style-type: none"> • PC • PA reinforced 	
Product weight		[g]	90
Temperature range	Environment		[°C] -5 ... +50
	Storage		[°C] -20 ... +70
Dimensions W x L x H		[mm]	40 x 91 x 50
Corrosion resistance class CRC		2 ¹⁾	
CE marking		To EU EMC Directive ²⁾	
Approval certificate		RCM mark c UL us - Recognized (OL)	

- 1) Corrosion resistance class 2 to Festo standard 940 070
Components subject to moderate corrosion stress. External visible parts with primarily decorative surface requirements which are in direct contact with the surrounding industrial environment or media such as coolants or lubricating agents.
- 2) For information about the applicability of the component see the manufacturer's EC declaration of conformity at: www.festo.com/sp → Certificates.
If the component is subject to restrictions on usage in residential, office or commercial environments or small businesses, further measures to reduce the emitted interference may be necessary.

Fieldbus modules CTEU/Installation system CTEL

Technical data – CTEU-DN

Dimensions

Download CAD data → www.festo.com

CTEU-DN

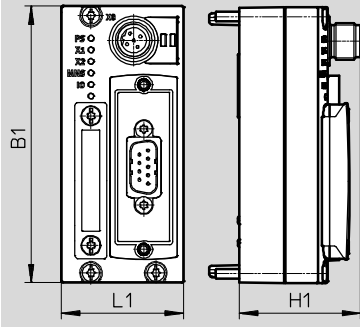

Type	B1	H1	L1
CTEU-DN	40	39.8	91

Pin allocation

	Pin	Allocation	Description
Sub-D, 9-pin, DeviceNet interface			
	1	n.c.	Not connected
	2	CAN_L	Received/transmitted data low
	3	CAN_GND	0 V CAN interface (connected to pin 6)
	4	n.c.	Not connected
	5	CAN_SHLD	Optional screened connection
	6	GND	0 V CAN interface, optional (connected to pin 3)
	7	CAN_H	Received/transmitted data high
	8	n.c.	Not connected
	9	CAN_V+	24 V DC supply CAN interface
	Housing		Cable screening, connection to functional earth FE
Power supply, M12, B-coded			
	1	24V _{EL/SEN}	Operating voltage supply (electronics, sensors/inputs)
	2	24V _{VAL/OUT}	Load voltage supply (valves/outputs)
	3	0V _{EL/SEN}	Operating voltage supply (electronics, sensors/inputs)
	4	0V _{VAL/OUT}	Load voltage supply (valves/outputs)
	5	FE	Functional earth

Fieldbus modules CTEU/Installation system CTEL



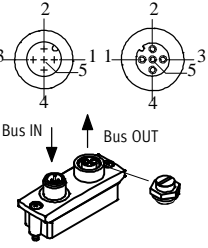
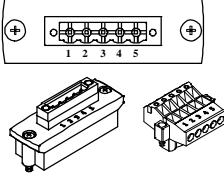

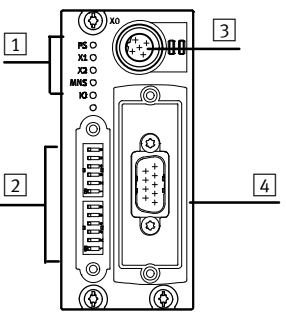

Technical data – CTEU-DN

Pin allocation for the DeviceNet interface			
Fieldbus plug connector/adaptor	Pin	Allocation	Description
Bus connection, FBA-2-M12-5POL			
	1	FE	Functional earth
	2	CAN_V+	24 V DC supply CAN interface
	3	CAN_GND	0 V CAN interface
	4	CAN_H	Received/transmitted data high
	5	CAN_L	Received/transmitted data low
Bus connection, FBA-1-SL-5POL with FBSD-KL-2X5POL			
	1	CAN_GND	0 V CAN interface
	2	CAN_L	Received/transmitted data low
	3	FE	Functional earth
	4	CAN_H	Received/transmitted data high
	5	CAN_V+	24 V DC supply CAN interface

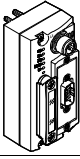
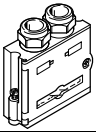
Connection and display components	
	<ol style="list-style-type: none"> 1 Status LED (operating status/diagnostics) 2 DIL switch group 3 Power supply for bus node and connected devices (valve terminal) 4 Fieldbus connection (Sub-D plug connector)

Fieldbus modules CTEU/Installation system CTEL

Accessories – CTEU-DN

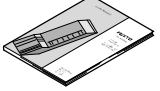
Ordering data		Part No.	Type
Bus node			
	DeviceNet bus node	570039	CTEU-DN
Bus connection			
	Sub-D plug connector, straight	532219	FBS-SUB-9-BU-2x5POL-B
	Micro Style bus connection, 2xM12, 5-pin, A-coded	525632	FBA-2-M12-5POL
	Socket for Micro Style connection, M12, 5-pin	18324	FBSD-GD-9-5POL
	Plug connector for Micro Style connection, M12, 5-pin	175380	FBS-M12-5GS-PG9
	Open Style bus connection	525634	FBA-1-SL-5POL
	Terminal strip for Open Style connection, 5-pin	525635	FBSD-KL-2x5POL
Fitting			
	Threaded sleeve for Sub-D	533000	UNC4-40/M3X8
Plug socket			
	For power supply	538999	NTSD-GD-9-M12-5POL-RK
User documentation			
	User documentation – bus node CTEU-DN	German	573744 P.BE-CTEU-DN-OP+MAINT-EN
		English	573745 P.BE-CTEU-DN-OP+MAINT-EN
		Spanish	573746 P.BE-CTEU-DN-OP+MAINT-ES
		French	573747 P.BE-CTEU-DN-OP+MAINT-FR
		Italian	573748 P.BE-CTEU-DN-OP+MAINT-IT
	Chinese	573779 P.BE-CTEU-DN-OP+MAINT-ZH	

Fieldbus modules CTEU/Installation system CTCL

Technical data – CTEU-CC



The bus node handles communication between the valve terminal and a higher-order master for Control & Communication Link (CC-Link®).

The module has basic diagnostic functions. It has 5 integrated LEDs for on-site display. A maximum of 8 byte inputs and 8 byte outputs are transmitted in the cyclic process image.



Application

Fieldbus connection

The bus connection is established by means of a screw terminal with IP20 degree of protection, a 9-pin Sub-D plug connector with IP65/IP67 degree of protection from Festo or a Sub-D plug connector with IP20 degree of protection from other manufacturers.

The module has a system and load supply, a fieldbus connection and a connection to the valve terminal with serial I-Port interface.

Both connection types have the function of an integrated T-distributor and thus support the connection of an incoming and outgoing bus cable.

The integrated interface with RS485 transmission technology is designed for the typical CC-Link 3-wire connection technology (in accordance with CLPA CC-Link Spec. V1.1).

Implementation

Protocol chip used:

- MFP3 from Mitsubishi

Maximum CC-Link cable length (minimum 0.2 m between devices):

- 100 m at 10 Mbps
- 150 m at 5 Mbps
- 200 m at 2.5 Mbps
- 600 m at 625 kbps
- 1200 m at 156 kbps

When using branch lines: maximum branch line length 8 m, maximum 6 stations per branch line

Length of main string:

- 100 m at 625 kbps, total length of branch line 50 m
- 500 m at 156 kbps, total length of branch line 200 m

Higher baud rates not permitted with a branch line.

The following variants can be realised using an adapter:

- Spring-loaded terminal In/Out with IP65 degree of protection (adapter 532220)
- Screw-in clamping connector with IP20 degree of protection (adapter 197962)

Fieldbus modules CTEU/Installation system CTEL

Technical data – CTEU-CC

General technical data			
Fieldbus interface			<ul style="list-style-type: none"> • Sub-D socket, 9-pin • Sub-D plug connector, for self-assembly • Screw terminal strip, IP20
Protocol			CC-Link
Baud rates		[kbps]	156 ... 10000
Internal cycle time			1 ms per 1 byte of user data
Operating voltage		Nominal value	[V DC] 24
		Permissible range	[V DC] 18 ... 30
Intrinsic current consumption at nominal operating voltage		[mA]	Typically 70
Max. power supply		[A]	4
Max. address capacity, inputs			16 bytes
Max. address capacity, outputs			16 bytes
Control elements			DIL switches
Device-specific diagnostics			<ul style="list-style-type: none"> • System diagnostics • Undervoltage • Communication error
Additional functions			<ul style="list-style-type: none"> • System status can be displayed using process data
Parameterisation			<ul style="list-style-type: none"> • Activate diagnostics • Fail-safe and idle response
LED display		Fieldbus-specific	<ul style="list-style-type: none"> • Err: data transmission error • Run: bus active
		Product-specific	<ul style="list-style-type: none"> • PS: Operating voltage for electronics and load supply • X1: System status of module at I-Port 1 • X2: System status of module at I-Port 2
Degree of protection to EN 60529			IP65/IP67
Note on materials			RoHS compliant
Information on materials - housing			<ul style="list-style-type: none"> • PC • PA reinforced
Temperature range		Environment	[°C] -5 ... +50
		Storage	[°C] -20 ... +70
Dimensions W x L x H		[mm]	40 x 91 x 50
Product weight		[g]	90
Corrosion resistance class CRC			2 ¹⁾
CE marking			To EU EMC Directive ²⁾
Approval certificate			RCM trademark c UL us listed (OL)

1) Corrosion resistance class 2 to Festo standard 940 070

Components subject to moderate corrosion stress. External visible parts with primarily decorative surface requirements which are in direct contact with the surrounding industrial environment or media such as coolants or lubricating agents.

2) For information about the applicability of the component see the manufacturer's EC declaration of conformity at: www.festo.com/sp → Certificates.

If the component is subject to restrictions on usage in residential, office or commercial environments or small businesses, further measures to reduce the emitted interference may be necessary.

Fieldbus modules CTEU/Installation system CTEL

Technical data – CTEU-CC

Dimensions Download CAD data → www.festo.com
CTEU-CC

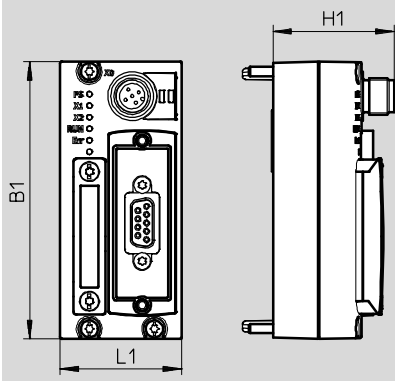

Type	B1	H1	L1
CTEU-CC	91	39.8	40

Pin allocation			
	Pin	Allocation	Description
Sub-D, 9-pin, CC-Link interface			
	1	n.c.	Not connected
	2	DA	Data transmission line A
	3	DG	Data transmission line ground (data reference potential)
	4	n.c.	Not connected
	5	n.c.	Not connected
	6	n.c.	Not connected
	7	DB	Data transmission line B
	8	n.c.	Not connected
	9	n.c.	Not connected
		Housing	
Power supply, M12, A-coded			
	1	24V _{EL/SEN}	Operating voltage supply (electronics, sensors/inputs)
	2	24V _{VAL/OUT}	Load voltage supply (valves/outputs)
	3	0V _{EL/SEN}	Operating voltage supply (electronics, sensors/inputs)
	4	0V _{VAL/OUT}	Load voltage supply (valves/outputs)
	5	FE	Functional earth

Fieldbus modules CTEU/Installation system CTEL

Technical data – CTEU-CC-Link

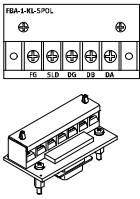
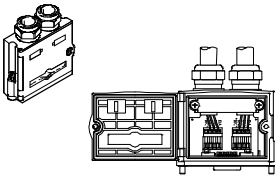

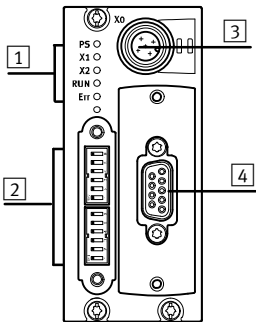

Pin allocation for the CC-Link interface		
Fieldbus plug connector/adapter	Pin	Description
Bus connection with terminal strip, FBA-1-KL-5POL		
	FE	Functional earth
	SLD	Cable screening
	DG	Data transmission line ground (data reference potential)
	DB	Data transmission line B
	DA	Data transmission line A
Bus connection, FBS-SUB-9-GS-24XPOL-B		
	DA	Data transmission line A
	DB	Data transmission line B
	DG	Data transmission line ground (data reference potential)
	n.c.	Not connected
	FE	Connected to the housing of the Sub-D plug connector by means of the clamp strap

Connection and display components	
	<ol style="list-style-type: none"> 1 Status LED (operating status/diagnostics) 2 DIL switch 3 Power supply for bus node and connected devices (valve terminal) 4 Fieldbus connection (Sub-D plug connector)

Fieldbus modules CTEU/Installation system CTEL

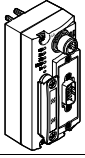
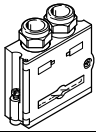
FESTO

Accessories – CTEU-CC-Link

Ordering data		Part No.	Type
Bus node			
	CC-Link bus node	1544198	CTEU-CC
Bus connection			
	Sub-D plug connector, straight	532220	FBS-SUB-9-GS-2x4POL-B
	Screw terminal bus connection	197962	FBA-1-KL-5POL
Fitting			
	Threaded sleeve for Sub-D	533000	UNC4-40/M3X8
Plug socket			
	For power supply, M12x1, 5-pin	18324	FBSD-GD-9-5POL

Fieldbus modules CTEU/Installation system CTEL

Technical data – CTEU-PB



The bus node handles communication between the valve terminal and a higher-order master for PROFIBUS DP®.

The module has basic diagnostic functions. It has 4 integrated LEDs for on-site display. A maximum of 8 byte inputs and 8 byte outputs are transmitted in the cyclic process image.



Application

Fieldbus connection

The bus connection is established via a 9-pin Sub-D socket with a typical PROFIBUS allocation (to EN 50170).

The bus connector plug (with IP65/IP67 degree of protection from Festo or IP20 degree of protection from other manufacturers) facilitates the connection of an incoming and an outgoing bus cable.

An active bus terminal can be connected using the DIL switch integrated in the plug connector.

The Sub-D interface is designed for controlling network components with a fibre-optic cable connection.

Transmission rate/overview of cable lengths

- RS 485 transceiver used: Analog Devices ADM 2485
- PROFIBUS Slave Controller used: Profichip VPC+S

Possible transmission rate:	Maximum fieldbus length:	Maximum branch line length:
9.6 kbps	1200 m	500 m
19.2 kbps	1200 m	500 m
93.75 kbps	1200 m	100 m
187.5 kbps	1000 m	33.3 m
500 kbps	400 m	20 m
1.5 Mbps	200 m	6.6 m
3 Mbps - 12 Mbps	100 m	-

Fieldbus modules CTEU/Installation system CTCL

Technical data – CTEU-PB

General technical data			
Fieldbus interface		<ul style="list-style-type: none"> • Sub-D socket, 9-pin • Sub-D plug connector, for self-assembly • 2x M12x1, 5-pin, B-coded 	
Protocol		PROFIBUS DP	
Baud rates		[kbps]	9.6, 19.2, 93.75, 187.5, 500
		[Mbps]	1.5, 12
Internal cycle time		1 ms per 1 byte of user data	
Operating voltage		Nominal value [V DC]	24
		Permissible range [V DC]	18 ... 30
Intrinsic current consumption at nominal operating voltage		[mA]	Typically 100
Max. power supply		[A]	2
Parameterisation		Diagnostic behaviour Fail-safe response	
Max. address capacity, inputs		16 bytes	
Max. address capacity, outputs		16 bytes	
Additional functions		<ul style="list-style-type: none"> • System status using diagnostics program • Emergency message 	
Control elements		DIL switches	
Configuration support		GSD files	
Device-specific diagnostics		<ul style="list-style-type: none"> • System diagnostics • Undervoltage • Communication error 	
LED display		Fieldbus-specific	• BF: Bus fault
		Product-specific	<ul style="list-style-type: none"> • PS: Operating voltage for electronics and load supply • X1: System status of module at I-Port 1 • X2: System status of module at I-Port 2
Degree of protection to EN 60529		IP65/IP67	
Note on materials		RoHS compliant	
Information on materials - housing		<ul style="list-style-type: none"> • PC • PA reinforced 	
Product weight		[g]	90
Temperature range		Environment [°C]	-5 ... +50
		Storage [°C]	-20 ... +70
Dimensions W x L x H		[mm]	40 x 91 x 50
Corrosion resistance class CRC		2 ¹⁾	
CE marking		To EU EMC Directive ²⁾	
Approval certificate		RCM mark c UL us - Recognized (OL)	

- 1) Corrosion resistance class 2 to Festo standard 940 070
Components subject to moderate corrosion stress. External visible parts with primarily decorative surface requirements which are in direct contact with the surrounding industrial environment or media such as coolants or lubricating agents.
- 2) For information about the applicability of the component see the manufacturer's EC declaration of conformity at: www.festo.com/sp → Certificates.
If the component is subject to restrictions on usage in residential, office or commercial environments or small businesses, further measures to reduce the emitted interference may be necessary.

Fieldbus modules CTEU/Installation system CTEL

Technical data – CTEU-PB

Dimensions Download CAD data → www.festo.com
 CTEU-PB



Type	B1	H1	L1
CTEU-PB	91	39.8	40

Pin allocation			
	Pin	Allocation	Description
Sub-D, 9-pin, PROFIBUS interface			
	1	Screening	Functional earth
	2	n.c.	Not connected
	3	RxD/TxD-P	Received/transmitted data positive
	4	CNTR-P	Repeater control signal
	5	DGND	Data ground
	6	VP	Supply voltage positive (+ 5 V)
	7	n.c.	Not connected
	8	RxD/TxD-N	Received/transmitted data negative
	9	n.c.	Not connected
		Housing	
Power supply, M12, A-coded			
	1	24V _{EL/SEN}	Operating voltage supply (electronics, sensors/inputs)
	2	24V _{VAL/OUT}	Load voltage supply (valves/outputs)
	3	0V _{EL/SEN}	Operating voltage supply (electronics, sensors/inputs)
	4	0V _{VAL/OUT}	Load voltage supply (valves/outputs)
	5	FE	Functional earth

Fieldbus modules CTEU/Installation system CTEL







Technical data – CTEU-PB

Pin allocation for PROFIBUS interface			
Fieldbus adapter	Pin	Bus IN	Bus OUT
Bus connection, FBA-2-M12-5POL-RK			
	1	n.c.	VP
	2	RxD/TxD-N	RxD/TxD-N
	3	n.c.	DGND
	4	RxD/TxD-P	RxD/TxD-P
	5	FE	Functional earth

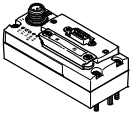
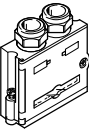
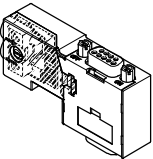
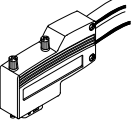
Connection and display components	
	<ul style="list-style-type: none"> 1 Status LED (operating status/diagnostics) 2 DIL switch 3 Power supply for bus node and connected devices (valve terminal) 4 Fieldbus connection (Sub-D plug connector)

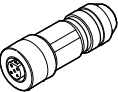
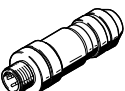
Fieldbus modules CTEU/Installation system CTEL

Accessories – CTEU-PB

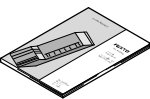
Ordering data		Part No.	Type
Bus node			
	PROFIBUS bus node	570040	CTEU-PB
Bus connection			
	Sub-D plug connector, straight	532216	FFBS-SUB-9-GS-DP-B
	Sub-D straight plug connector with terminating resistor and programming interface	574589	NECU-S1W9-C2-APB
	Sub-D plug connector, angled	533780	FBS-SUB-9-WS-PB-K
	Bus connection M12 adapter, B-coded	533118	FBA-2-M12-5POL-RK
	Straight socket, M12x1, 5-pin, for assembling a connecting cable compatible with FBA-2-M12-5POL-RK	1067905	NECU-M-B12G5-C2-PB
	Straight plug connector, M12x1, 5-pin, for assembling a connecting cable compatible with FBA-2-M12-5POL-RK	1066354	NECU-M-S-B12G5-C2-PB
	Terminating resistor, M12, B-coded for PROFIBUS	1072128	CACR-S-B12G5-220-PB
Fitting			
	Threaded sleeve for Sub-D	533000	UNC4-40/M3X8
Plug socket			
	For power supply, M12x1, 5-pin	18324	FBSD-GD-9-5POL
User documentation			
	User documentation – bus node CTEU-PB	German	575392 P.BE-CTEU-PB-OP+MAINT-DE
		English	575393 P.BE-CTEU-PB-OP+MAINT-EN
		Spanish	575394 P.BE-CTEU-PB-OP+MAINT-ES
		French	575395 P.BE-CTEU-PB-OP+MAINT-FR
		Italian	575396 P.BE-CTEU-PB-OP+MAINT-IT
		Chinese	575397 P.BE-CTEU-PB-OP+MAINT-ZH

Fieldbus modules CTEU/Installation system CTEL

Technical data – CTEU-EC

FESTO



The bus node handles communication between the valve terminal and a higher-order master for EtherCAT®.

The module has basic diagnostic functions. It has 6 integrated status LEDs for on-site display. A maximum of 16 byte inputs and 16 byte outputs are transmitted in the cyclic process image.



Application

Fieldbus connection

The bus connection is established via two M12 sockets, D-coded to IEC61076-2-101 with degree of protection IP65/IP67. Both connections are equivalent 100BaseTX Ethernet ports with integrated auto MDI functionality (cross-over and patch cables can be used)

that are brought together via an internal switch.

The module has a system and load supply, a fieldbus connection and a connection to the valve terminal with serial I-Port interface.

Please observe the applicable specifications such as the cable specifications for Ethernet networks ISO/IEC11801 and ANSI/TIA/EIA-568-B.

- Maximum cable length (between network stations): 100 m
- Transmission rate: 100 Mbps
- EtherCAT communication chip: ASIC ET1100

EtherCAT bus node

The EtherCAT bus node supports the EtherCAT protocol based on the Ethernet standard and TCP/IP technology to IEEE802.3.

This guarantees a data exchange with a high data transmission rate, for example I/O data from sensors, actuators or robot controllers, PLCs or process equipment. Furthermore, non

real-time critical information such as diagnostic information, configuration information, etc. can be transferred. The data bandwidth is sufficient to transmit both data types (real-time and non-real-time) in parallel.

The bus node has a system and load supply, EtherCAT input and output

port, LEDs for status and diagnostic messages and DIL switch elements. Diagnostics is possible directly at the bus node and/or via fieldbus. The bus node has separate operating and load voltage supplies. The bus node is mounted on an I-Port compatible device (e.g. valve terminal or connecting block) from Festo.

The bus node supplies voltage to downstream devices connected by means of the I-Port interface.

The following can be set via DIL switch:

- Station addresses
- Diagnostics on/off
- Fail state behaviour

Fieldbus modules CTEU/Installation system CTEL

Technical data – CTEU-EC

General technical data			
Fieldbus interface		2x M12 socket, D-coded, 4-pin	
Protocol		EtherCAT	
Baud rates		[Mbps]	100
Internal cycle time		1 ms per 1 byte of user data	
Operating voltage (PS)	Nominal value	[V DC]	24
	Permissible range	[V DC]	18 ... 30
	Power failure buffering	[ms]	10
Load voltage (PL)	Max.	[V DC]	30
	Typical tolerance range	[V DC]	18 ... 30
Max. power supply		[A]	4
Intrinsic current consumption at nominal operating voltage		[mA]	Typically 60
Max. address capacity, inputs		[byte]	16
Max. address capacity, outputs		[byte]	16
LED display	Fieldbus-specific	<ul style="list-style-type: none"> • Run: operating status (communication status) • L/A2: network active (connection status) port 2 (Out) • L/A1: network active (connection status) port 1 (In) 	
	Product-specific	<ul style="list-style-type: none"> • PS: Operating voltage for electronics and load supply • X1: System status of module at I-Port 1 • X2: System status of module at I-Port 2 	
Device-specific diagnostics		<ul style="list-style-type: none"> • System diagnostics • Undervoltage • Communication error 	
Additional functions		<ul style="list-style-type: none"> • Diagnostics object • Acyclic data access via "SDO" • Emergency message • Modular device profile (MDP) 	
Configuration support		XML file	
Parameterisation		<ul style="list-style-type: none"> • Diagnostic behaviour • Fail-safe response 	
Control elements		DIL switches	
Parameterisation via DIL switches		<ul style="list-style-type: none"> • Fail-safe and idle response • Diagnostics on/off 	
Degree of protection to EN 60529		IP65	
Corrosion resistance class CRC		2 ¹⁾	
CE marking (see declaration of conformity)		To EU EMC Directive ²⁾	
Approval certificate		RCM mark c UL us - Recognized (OL)	
Temperature range	Operation	[°C]	- 5 ... +50
	Storage/transport	[°C]	-20 ... +70
Note on materials		RoHS compliant	
Information on materials - housing		<ul style="list-style-type: none"> • PC • PA reinforced 	
Dimensions W x L x H		[mm]	40 x 91 x 50
Product weight		[g]	90

1) Corrosion resistance class 2 to Festo standard 940 070

Components subject to moderate corrosion stress. External visible parts with primarily decorative surface requirements which are in direct contact with the surrounding industrial environment or media such as coolants or lubricating agents.

2) For information about the applicability of the component see the manufacturer's EC declaration of conformity at: www.festo.com/sp → Certificates.

If the component is subject to restrictions on usage in residential, office or commercial environments or small businesses, further measures to reduce the emitted interference may be necessary.

Fieldbus modules CTEU/Installation system CTEL

Technical data – CTEU-EC

Dimensions

Download CAD data → www.festo.com

CTEU-EC

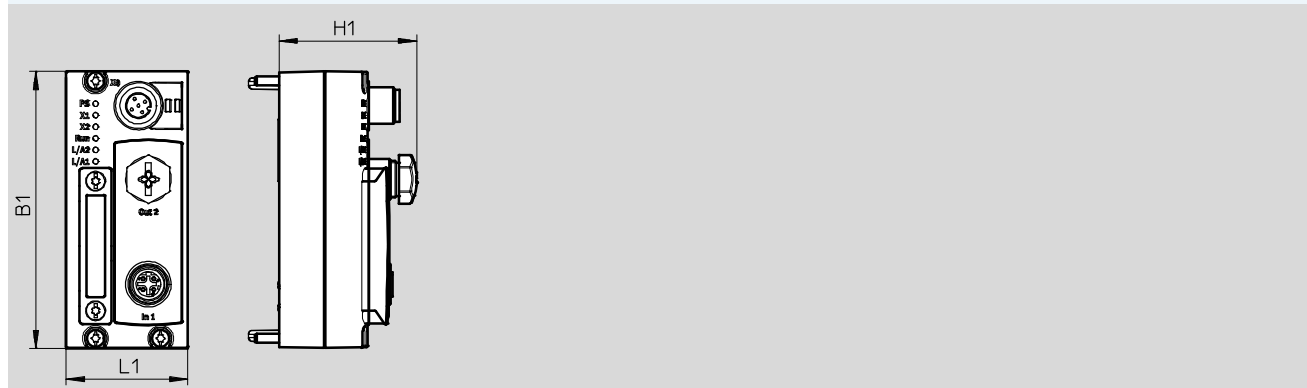

Type	B1	H1	L1
CTEU-EC	91	45.3	40

Pin allocation





	Pin	Allocation	Description
EtherCAT interface, M12, D-coded			
	1	TX+	Transmitted data+
	2	RX+	Received data+
	3	TX-	Transmitted data-
	4	RX-	Received data-
	Housing		
Power supply, M12, A-coded			
	1	24V _{EL} /SEN	Operating voltage supply (electronics, sensors/inputs)
	2	24V _{VAL} /OUT	Load voltage supply (valves/outputs)
	3	0V _{EL} /SEN	Operating voltage supply (electronics, sensors/inputs)
	4	0V _{VAL} /OUT	Load voltage supply (valves/outputs)
	5	FE	Functional earth

Connection and display components

	<ol style="list-style-type: none"> 1 Status LED (operating status/diagnostics) 2 DIL switch 3 Power supply for bus node and connected devices (valve terminal) 4 Fieldbus connection (M12 socket, D-coded)
--	--

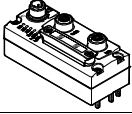
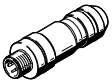
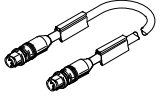
Fieldbus modules CTEU/Installation system CTEL

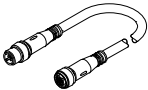
Accessories – CTEU-EC

Ordering data				Part No.	Type	
Bus node						
	EtherCAT bus node			572556	CTEU-EC	
Plug connector for bus connection						
	Plug, M12x1, 4-pin, D-coded			543109	NECU-M-S-D12G4-C2-ET	
Connecting cable for bus connection						
	Straight plug, M12x1, 4-pin, D-coded	Straight plug, M12x1, 4-pin, D-coded	0.5 m	8040446	NEBC-D12G4-ES-0.5-S-D12G4-ET	
			1 m	8040447	NEBC-D12G4-ES-1-S-D12G4-ET	
			3 m	8040448	NEBC-D12G4-ES-3-S-D12G4-ET	
			5 m	8040449	NEBC-D12G4-ES-5-S-D12G4-ET	
			10 m	8040450	NEBC-D12G4-ES-10-S-D12G4-ET	
			Straight plug, RJ45, 8-pin	1 m	8040451	NEBC-D12G4-ES-1-S-R3G4-ET
				3 m	8040452	NEBC-D12G4-ES-3-S-R3G4-ET
				5 m	8040453	NEBC-D12G4-ES-5-S-R3G4-ET
				10 m	8040454	NEBC-D12G4-ES-10-S-R3G4-ET
			Open end, 4-wire	5 m	8040456	NEBC-LE4-ES-5-D12G4-ET
Plug socket for power supply						
	Socket, M12x1, 5-pin			18324	FBSD-GD-9-5POL	
Connecting cable for power supply						
	<ul style="list-style-type: none"> Socket, M12x1, 5-pin Plug, M12x1, 5-pin 	Suitable for chain link trunking	5 m	574321	NEBU-M12G5-E-5-Q8N-M12G5	
			7.5 m	574322	NEBU-M12G5-E-7.5-Q8N-M12G5	
			10 m	574323	NEBU-M12G5-E-10-Q8N-M12G5	
			Standard	0.5 m	570733	NEBU-M12W5-K-0.5-M12W5
					8003617	NEBU-M12G5-K-0.5-M12W5
				2 m	570734	NEBU-M12W5-K-2-M12W5
					8003618	NEBU-M12G5-K-2-M12W5
User documentation						
	User documentation – bus node CTEU-EC	German	575400	P.BE-CTEU-EC-OP+MAINT-DE		
		English	575401	P.BE-CTEU-EC-OP+MAINT-EN		
		Spanish	575402	P.BE-CTEU-EC-OP+MAINT-ES		
		French	575403	P.BE-CTEU-EC-OP+MAINT-FR		
		Italian	575404	P.BE-CTEU-EC-OP+MAINT-IT		
		Chinese	575405	P.BE-CTEU-EC-OP+MAINT-ZH		

Fieldbus modules CTEU/Installation system CTEL

Technical data – CTEU-AS



The bus node handles communication between the valve terminal and a higher-order AS-Interface® master.

- Activation of up to 16 solenoid coils per valve terminal
- Automatic addressing
- Automatic detection of the number of connected valves



Properties

The module has a system and load supply, a bus connection and a connection to the valve terminal with serial I-Port interface.

The module has basic diagnostic functions. It has 3 integrated LEDs for on-site display.

A maximum of 2 byte inputs and 2 byte outputs are transmitted in the cyclic process image.

General technical data

Fieldbus interface		<ul style="list-style-type: none"> • Plug connector M12x1, 4-pin, A-coded • Socket M12x1, 4-pin, A-coded
Protocol		AS-Interface
Internal cycle time	[ms]	10
Operating voltage	Nominal value	[V DC] 30
	Permissible range	[V DC] 20 ... 31.6
Intrinsic current consumption at nominal operating voltage	[mA]	Typically 50
Max. power supply	[A]	4
Max. address capacity, inputs		2 bytes
Max. address capacity, outputs		2 bytes
Control elements		DIL switches
Device-specific diagnostics		<ul style="list-style-type: none"> • System diagnostics • Undervoltage • Communication error
Parameterisation		<ul style="list-style-type: none"> • Watchdog enable • Watchdog disable
LED display	Bus-specific	• AS-Interface operation
	Product-specific	<ul style="list-style-type: none"> • PS: Operating voltage for electronics and load supply • X1: System status of module at I-Port 1
Degree of protection to EN 60529		IP65/IP67
Note on materials		RoHS compliant
Information on materials - housing		PA reinforced
Temperature range	Environment	[°C] -5 ... +50
	Storage	[°C] -20 ... +70
Dimensions W x L x H	[mm]	40 x 91 x 50
Product weight	[g]	90
Corrosion resistance class CRC		2 ¹⁾
CE marking		To EU EMC Directive ²⁾
Approval certificate		c UL us - Recognized (OL)

1) Corrosion resistance class 2 to Festo standard 940 070
Components subject to moderate corrosion stress. External visible parts with primarily decorative surface requirements which are in direct contact with the surrounding industrial environment or media such as coolants or lubricating agents.

2) For information about the applicability of the component see the manufacturer's EC declaration of conformity at: www.festo.com/sp → Certificates.
If the component is subject to restrictions on usage in residential, office or commercial environments or small businesses, further measures to reduce the emitted interference may be necessary.

Fieldbus modules CTEU/Installation system CTEL

Technical data – CTEU-AS

Dimensions

CTEU-AS

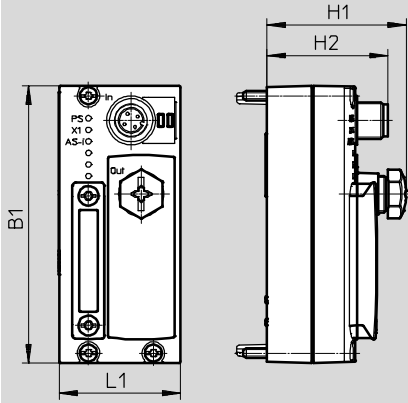

Type	B1	H1	H2	L1
CTEU-AS	91	45.3	39.7	40

Pin allocation

	Pin	Allocation
M12 plug connector, AS-Interface In		
	1	AS-Interface +
	2	24 V load voltage supply
	3	AS-Interface -
	4	0 V load voltage supply
M12 socket, AS-Interface Out		
	1	AS-Interface +
	2	24 V load voltage supply
	3	AS-Interface -
	4	0 V load voltage supply







Connection and display components

	1	Status LED (operating status/diagnostics)
	2	DIL switch
	3	M12 plug connector, AS-Interface bus and auxiliary power supply (AS-Interface In)
	4	M12 socket, AS-Interface bus and auxiliary power supply (AS-Interface Out)

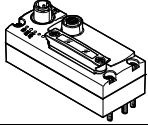
Fieldbus modules CTEU/Installation system CTEL

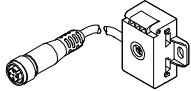

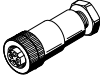
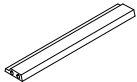
Accessories – CTEU-AS

Ordering data				Part No.	Type
Bus node					
	AS-Interface bus node			572555	CTEU-AS
Cable socket with load voltage supply					
	Flat cable	4-pin socket, M12x1, A-coded	–	572226	NEFU-X24F-M12G4
	Flat cable	4-pin socket, M12x1, A-coded	1 m	572227	NEFU-X24F-1-M12G4
Cable socket without load voltage supply					
	Flat cable	4-pin socket, M12x1, A-coded		572225	NEFU-X22F-M12G4
	Flat cable, screw terminal	4-pin straight socket, M12x1, A-coded		18789	ASI-SD-PG-M12
Flat cable					
	AS-Interface flat cable	Yellow		18940	KASI-1,5-Y-100
		Black		18941	KASI-1,5-Z-100
	Cable sleeve for insulating and sealing the flat cable			165593	ASI-KT-FK
	Cable cap for insulating and sealing the flat cable			18787	ASI-KK-FK

Fieldbus modules CTEU/Installation system CTEL

Technical data – CTEU-PN



The bus node handles communication between the valve terminal and a higher-order PROFINET® master.

The module has basic diagnostic functions. It has 6 integrated LEDs for on-site display. A maximum of 64 byte inputs and 64 byte outputs are transmitted in the cyclic process image.



Application

Fieldbus connection

The bus connection is established via two M12 sockets, D-coded to IEC61076-2-101 with degree of protection IP65, IP67.

Both connections are equivalent 100BaseTX Ethernet ports (as per IEEE 802.3).

There is also an integrated switch function that enables free selection of the ports TP1/TP2 for PROFINET communication.

The voltage for the CTEU-PN bus node is supplied via an M12 plug connector, 5-pin, A-coded.

I-port interface

The bus node supports two interfaces for connecting I-Port devices.

When mounting the bus node on a valve terminal (direct integration) only one interface is used.

When using the CTEU-PN bus node on the electrical connection block CAPC (installation system CTEL)

both interfaces are available via the connecting plate.

Fieldbus modules CTEU/Installation system CTEL

Technical data – CTEU-PN

General technical data			
Fieldbus interface	2x M12x1 socket, 4-pin, D-coded		
Protocol	PROFINET		
Baud rates	[Mbps]	100	
Internal cycle time	1 ms per 1 byte of user data		
Operating voltage	Nominal value	[V DC]	24
	Permissible range	[V DC]	18 ... 30
Intrinsic current consumption at nominal operating voltage	[mA]	Typically 80	
Max. power supply	[A]	4	
Max. address capacity, inputs	64 bytes		
Max. address capacity, outputs	64 bytes		
Additional functions	<ul style="list-style-type: none"> • Conformance class C • Fast start-up (FSU) • LLDP • MRP • PROFINET IRT • PROFinergy • SNMP • Shared device • Web servers 		
Configuration support	GSDML file		
Device-specific diagnostics	<ul style="list-style-type: none"> • System diagnostics • Undervoltage • Communication error 		
LED display	Bus-specific	<ul style="list-style-type: none"> • NF: Network fault • TP1: Network active port 1 • TP2: Network active port 2 	
	Product-specific	<ul style="list-style-type: none"> • PS: Operating voltage for electronics and load supply • X1: System status of module at I-Port 1 • X2: System status of module at I-Port 2 	
Degree of protection to EN 60529	IP65/IP67		
Note on materials	RoHS compliant		
Information on materials - housing	<ul style="list-style-type: none"> • PC • PA reinforced 		
Product weight	[g]	93	
Temperature range	Environment	[°C]	-5 ... +50
	Storage	[°C]	-20 ... +70
Dimensions W x L x H	[mm]	40 x 91 x 50	
Corrosion resistance class CRC	2 ¹⁾		
CE marking	To EU EMC Directive ²⁾		
Approval certificate	RCM mark c UL us - Recognized (OL)		

- 1) Corrosion resistance class 2 to Festo standard 940 070
Components subject to moderate corrosion stress. External visible parts with primarily decorative surface requirements which are in direct contact with the surrounding industrial environment or media such as coolants or lubricating agents.
- 2) For information about the applicability of the component see the manufacturer's EC declaration of conformity at: www.festo.com/sp → Certificates.
If the component is subject to restrictions on usage in residential, office or commercial environments or small businesses, further measures to reduce the emitted interference may be necessary.

Fieldbus modules CTEU/Installation system CTEL

Technical data – CTEU-PN

Dimensions

Download CAD data → www.festo.com

CTEU-PN

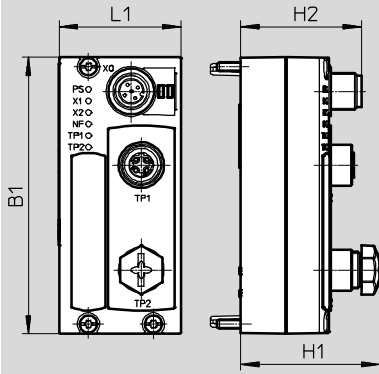

Type	B1	H1	H2	L1
CTEU-PN	91	45.7	39.7	40

Pin allocation

	Pin	Allocation	Description
PROFINET interface, M12 socket, 4-pin, D-coded			
	1	TX+	Differential transmitter cable, positive signal
	2	RX+	Differential receiver cable, positive signal
	3	TX-	Differential transmitter cable, negative signal
	4	RX-	Differential receiver cable, negative signal
	Housing		Functional earth
Power supply, M12 plug connector, 5-pin, A-coded			
	1	24V _{EL} /SEN	Operating voltage supply (internal electronics, I-Port devices)
	2	24V _{VAL} /OUT	Load voltage supply (I-Port devices)
	3	0V _{EL} /SEN	Operating voltage supply (internal electronics, I-Port devices)
	4	0V _{VAL} /OUT	Load voltage supply (I-Port devices)
	5	FE	Functional earth



Connection and display components

	<ul style="list-style-type: none"> 1 Status LED (operating status/diagnostics) 2 Power supply for bus node and connected devices (valve terminal) 3 Fieldbus connection
--	--

Fieldbus modules CTEU/Installation system CTEL

FESTO

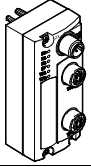
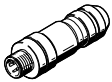
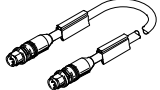
Accessories – CTEU-PN

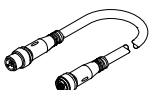
Ordering data				Part No.	Type
Bus node					
	PROFINET bus node			2201471	CTEU-PN
Plug connector for bus connection					
	Plug, M12x1, 4-pin, D-coded			543109	NECU-M-S-D12G4-C2-ET
Connecting cable for bus connection					
	Straight plug, M12x1, 4-pin, D-coded	Straight plug, M12x1, 4-pin, D-coded	0.5 m	8040446	NEBC-D12G4-ES-0.5-S-D12G4-ET
			1 m	8040447	NEBC-D12G4-ES-1-S-D12G4-ET
			3 m	8040448	NEBC-D12G4-ES-3-S-D12G4-ET
			5 m	8040449	NEBC-D12G4-ES-5-S-D12G4-ET
			10 m	8040450	NEBC-D12G4-ES-10-S-D12G4-ET
		Straight plug, RJ45, 8-pin	1 m	8040451	NEBC-D12G4-ES-1-S-R3G4-ET
			3 m	8040452	NEBC-D12G4-ES-3-S-R3G4-ET
			5 m	8040453	NEBC-D12G4-ES-5-S-R3G4-ET
			10 m	8040454	NEBC-D12G4-ES-10-S-R3G4-ET
Open end, 4-wire	5 m	8040456	NEBC-LE4-ES-5-D12G4-ET		
Plug socket for power supply					
	Socket, M12x1, 5-pin			18324	FBSD-GD-9-5POL
Connecting cable for power supply					
	<ul style="list-style-type: none"> Socket, M12x1, 5-pin Plug, M12x1, 5-pin 	Suitable for chain link trunking	5 m	574321	NEBU-M12G5-E-5-Q8N-M12G5
			7.5 m	574322	NEBU-M12G5-E-7.5-Q8N-M12G5
			10 m	574323	NEBU-M12G5-E-10-Q8N-M12G5
		Standard	0.5 m	570733	NEBU-M12W5-K-0.5-M12W5
				8003617	NEBU-M12G5-K-0.5-M12W5
			2 m	570734	NEBU-M12W5-K-2-M12W5
				8003618	NEBU-M12G5-K-2-M12W5

Fieldbus modules CTEU/Installation system CTEL

Technical data – CTEU-CP

CPI interface for integrating components with I-Port interface into the installation system CPI from Festo.

The module has basic diagnostic functions. It has 4 integrated LEDs for on-site display. A maximum of 4 byte inputs and 4 byte outputs are transmitted in the cyclic process image.

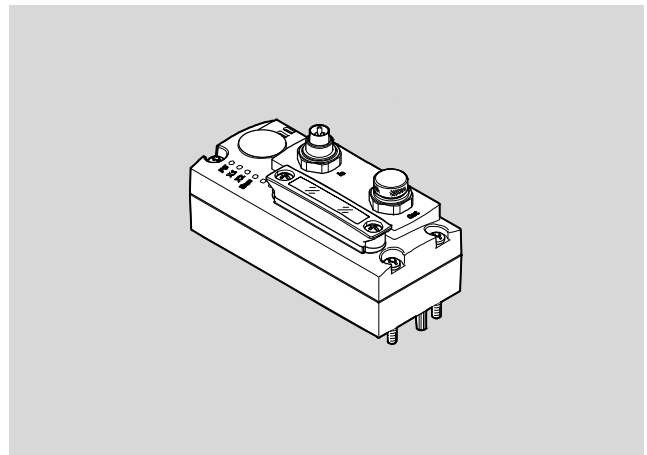

Application

Fieldbus connection/power supply

In the CPI system, the power supply and the communication signal are routed via a common port.

The bus node additionally has an M9 plug connector for connection to the signal coming from the CPI master and an M9 socket for transmitting the signal to other CPI modules.

The series connection of CPI modules (string) can contain a maximum of 4 modules with CPI functionality. The number of outputs/inputs per string is limited to 32 of each.

The maximum length of a string is 10 m.

I-port interface

The bus node supports two interfaces for connecting I-Port devices.

When mounting the bus node on a valve terminal (direct integration) only one interface is used.

When using the bus node CTEU-CP on the electrical connection block CAPC (installation system CTEL), both interfaces are available via the connection plate.

The total number of inputs/outputs that can be connected is limited by the overall configuration of the CP string.

Fieldbus modules CTEU/Installation system CTEL

Technical data – CTEU-CP

General technical data			
Fieldbus interface	<ul style="list-style-type: none"> • Plug connector M9x0.5, 5-pin • Socket M9x0.5, 5-pin 		
Protocol	CPI-B		
Number of internal communication interfaces	2		
Internal communication protocol	I-Port		
Baud rates	[kbps]	1000	
Internal cycle time	2 ms		
Operating voltage	Nominal value	[V DC]	24
	Permissible range	[V DC]	18 ... 30
Intrinsic current consumption at nominal operating voltage	[mA]	Typically 50	
Max. power supply	[A]	3.4	
Max. address capacity, inputs	4 bytes		
Max. address capacity, outputs	4 bytes		
Device-specific diagnostics	<ul style="list-style-type: none"> • System diagnostics • Undervoltage • Communication error 		
LED display	Bus-specific	• RUN: Communication OK	
	Product-specific	<ul style="list-style-type: none"> • PS: Operating voltage for electronics and load supply • X1: System status of module at I-Port 1 • X2: System status of module at I-Port 2 	
Parameterisation	Fail-safe response, diagnostic behaviour		
Degree of protection to EN 60529	IP65/IP67		
Note on materials	RoHS compliant		
Information on materials - housing	<ul style="list-style-type: none"> • PC • PA reinforced 		
Product weight	[g]	105	
Temperature range	Environment	[°C]	-5 ... +50
	Storage	[°C]	-20 ... +70
Dimensions W x L x H	[mm]	40 x 91 x 50	
Control elements	DIL switches		
Corrosion resistance class CRC	2 ¹⁾		
CE marking	To EU EMC Directive ²⁾		
Approval certificate	RCM trademark c UL us listed (OL)		

- 1) Corrosion resistance class 2 to Festo standard 940 070
Components subject to moderate corrosion stress. External visible parts with primarily decorative surface requirements which are in direct contact with the surrounding industrial environment or media such as coolants or lubricating agents.
- 2) For information about the applicability of the component see the manufacturer's EC declaration of conformity at: www.festo.com/sp → Certificates.
If the component is subject to restrictions on usage in residential, office or commercial environments or small businesses, further measures to reduce the emitted interference may be necessary.

Fieldbus modules CTEU/Installation system CTEL

Technical data – CTEU-CP

Dimensions

Download CAD data → www.festo.com

CTEU-CP

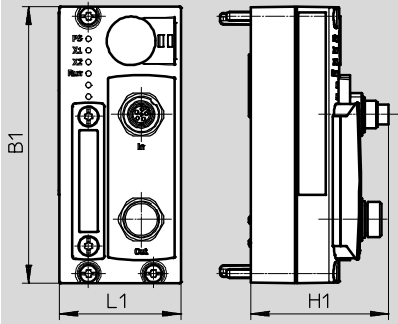

Type	B1	H1	L1
CTEU-CP	91	45.4	40





Connection and display components

The diagram shows the front view of the CTEU-CP module with four numbered callouts: 1 points to the status LED, 2 points to the DIL switch, 3 points to the 'In' port, and 4 points to the 'Out' port.

- 1 Status LED (operating status/diagnostics)
- 2 DIL switch
- 3 CP connection, incoming
- 4 CP connection, outgoing

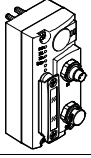
Fieldbus modules CTEU/Installation system CTEL

Accessories – CTEU-CP

Ordering data		Part No.	Type
Bus node			
	Bus node CP	2149714	CTEU-CP
Connecting cable for fieldbus connection/power supply			
	Angled plug connector - angled socket	0.25 m	540327 KVI-CP-3-WS-WD-0,25
		0.5 m	540328 KVI-CP-3-WS-WD-0,5
		2 m	540329 KVI-CP-3-WS-WD-2
		5 m	540330 KVI-CP-3-WS-WD-5
	Straight plug connector - straight socket	8 m	540331 KVI-CP-3-WS-WD-8
		2 m	540332 KVI-CP-3-GS-GD-2
		5 m	540333 KVI-CP-3-GS-GD-5
		8 m	540334 KVI-CP-3-GS-GD-8
Connector for fieldbus connection			
	Straight plug connector, 5-pin, M9 Straight socket, 5-pin, M9	543252	KVI-CP-3-SSD

Fieldbus modules CTEU/Installation system CTEL

Technical data – CTEU-EP



The bus node handles communication between the valve terminal and a higher-order master via Ethernet.

The module has basic diagnostic functions. It has 6 integrated LEDs for on-site display. A maximum of 64 byte inputs and 64 byte outputs are transmitted in the cyclic process image.

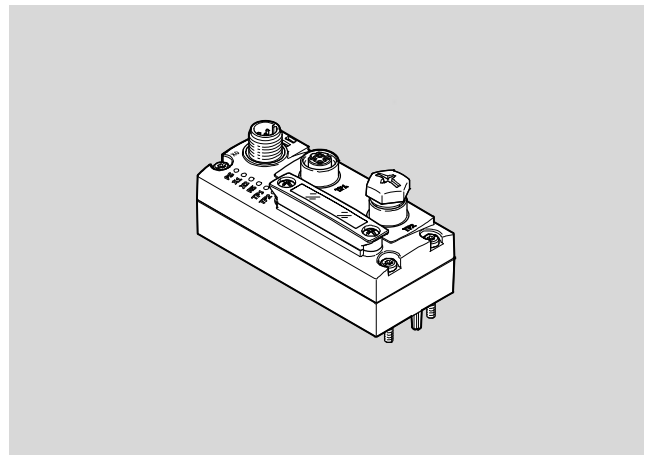

Application

The bus node CTEU-EP is a module within the CTEU series which can be used to connect I-Port devices with

specification V1.0 to an EtherNet/IP or Modbus/TCP bus. Depending on the installation, the bus

node provides two I-Port interfaces for the connection of I-Port devices.

Installation

Direct integration

- Mounting the bus node on an I-Port device, e.g. valve terminal
- One I-Port interface available (for internal communication)

CAPC adapter

- Mounting the bus node on the adapter
- Two I-Port interfaces available on the adapter

Power supply

Power is supplied to the bus node and the connected I-Port devices by means of an M12 plug connector, 5-pin, A-coded, on the top side of the housing.

Ethernet connection

The bus node CTEU-EP provides two 100BASE-TX Ethernet interfaces (to IEEE802.3) electrically isolated from the rest of the internal electronics. The integrated switch function differentiates automatically between the incoming and outgoing Ethernet connection, regardless of the network connection used.

Fieldbus modules CTEU/Installation system CTEL

Technical data – CTEU-EP

General technical data			
Fieldbus interface		2x M12x1 socket, 4-pin, D-coded	
Protocol		Ethernet/IP, Modbus/TCP	
Baud rates	[Mbps]	10/100	
Internal cycle time		1 ms per 1 byte of user data	
Operating voltage	Nominal value	[V DC]	24
	Permissible range	[V DC]	18 ... 30
Intrinsic current consumption at nominal operating voltage		[mA]	Typically 65
Max. power supply		[A]	4
Max. address capacity, inputs		[byte]	64
Max. address capacity, outputs		[byte]	64
Device-specific diagnostics		<ul style="list-style-type: none"> • System diagnostics • Undervoltage • Communication error 	
LED display	Bus-specific		<ul style="list-style-type: none"> • TP1: Network active port 1 • TP2: Network active port 2 • NS: Network status
	Product-specific		<ul style="list-style-type: none"> • PS: Operating voltage for electronics and load supply • X1: System status of module at I-Port 1 • X2: System status of module at I-Port 2
Additional functions		<ul style="list-style-type: none"> • AddressConflictDetection (ACD) • Acyclic data access via "Explicit Message" • EtherNet/IP Quickconnect • IP addressing via DHCP, DIL switch, fieldbus or FFT • Integrated switch • Ring topology (DLR) • SNMP • Start-up parameterisation in plain text via fieldbus • System status can be displayed using process data • Web servers 	
Control elements		DIL switches	
Configuration support		EDS file	
Parameterisation		Fail-safe and idle response, diagnostic behaviour	
Degree of protection to EN 60529		IP65/IP67	
Note on materials		RoHS compliant Contains paint-wetting impairment substances	
Information on materials - housing		Reinforced PA	
Product weight		[g]	98
Temperature range	Environment		[°C] -5 ... +50
	Storage		[°C] -20 ... +70
Dimensions W x L x H		[mm]	40 x 91 x 50
Corrosion resistance class CRC		2 ¹⁾	
CE marking		To EU EMC Directive ²⁾	
Approval certificate		RCM mark	

- 1) Corrosion resistance class 2 to Festo standard 940 070
Components subject to moderate corrosion stress. External visible parts with primarily decorative surface requirements which are in direct contact with the surrounding industrial environment or media such as coolants or lubricating agents.
- 2) For information about the applicability of the component see the manufacturer's EC declaration of conformity at: www.festo.com/sp → Certificates.
If the component is subject to restrictions on usage in residential, office or commercial environments or small businesses, further measures to reduce the emitted interference may be necessary.

Fieldbus modules CTEU/Installation system CTEL

Technical data – CTEU-EP

Dimensions

Download CAD data → www.festo.com

CTEU-EP

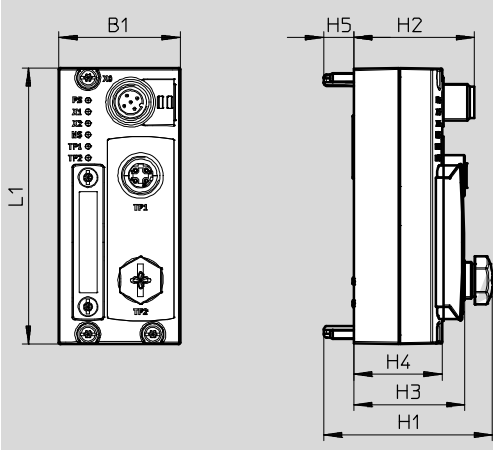

Type	L1	H1	H2	H3	H4	H5	B1
CTEU-EP	91	55.6	39.7	36.6	29.1	10	40

Connection and display components

The diagram shows the front view of the CTEU-EP module with four numbered callouts: 1 points to the status LED, 2 points to the DIL switch, 3 points to the network ports (TP1, TP2) and fieldbus interface, and 4 points to the power supply connection.



- 1 Status LED (operating status/diagnostics)
- 2 DIL switch
- 3 Network connections (network ports TP1/TP2, fieldbus interface)
- 4 Power supply connection

Pin allocation

	Pin	Allocation	Description
Ethernet interface, socket M12, 4-pin, D-coded			
	1	TX+	Differential transmitter cable, positive signal
	2	RX+	Differential receiver cable, positive signal
	3	TX-	Differential transmitter cable, negative signal
	4	RX-	Differential receiver cable, negative signal
	Housing		Functional earth
Power supply, M12, A-coded			
	1	24V _{EL} /SEN	Operating voltage supply (electronics, sensors/inputs)
	2	24V _{VAL} /OUT	Load voltage supply (valves/outputs)
	3	0V _{EL} /SEN	Operating voltage supply (electronics, sensors/inputs)
	4	0V _{VAL} /OUT	Load voltage supply (valves/outputs)
	5	FE	Functional earth

Fieldbus modules CTEU/Installation system CTEL

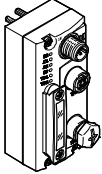
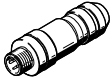
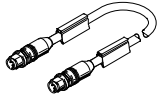
Accessories – CTEU-EP

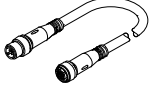
Ordering data				Part No.	Type	
Bus node						
	EP bus node			2798071	CTEU-EP	
Plug connector for bus connection						
	Plug, M12x1, 4-pin, D-coded			543109	NECU-M-S-D12G4-C2-ET	
Connecting cable for bus connection						
	Straight plug, M12x1, 4-pin, D-coded	Straight plug, M12x1, 4-pin, D-coded	0.5 m	8040446	NEBC-D12G4-ES-0.5-S-D12G4-ET	
			1 m	8040447	NEBC-D12G4-ES-1-S-D12G4-ET	
			3 m	8040448	NEBC-D12G4-ES-3-S-D12G4-ET	
			5 m	8040449	NEBC-D12G4-ES-5-S-D12G4-ET	
			10 m	8040450	NEBC-D12G4-ES-10-S-D12G4-ET	
			Straight plug, RJ45, 8-pin	1 m	8040451	NEBC-D12G4-ES-1-S-R3G4-ET
				3 m	8040452	NEBC-D12G4-ES-3-S-R3G4-ET
				5 m	8040453	NEBC-D12G4-ES-5-S-R3G4-ET
				10 m	8040454	NEBC-D12G4-ES-10-S-R3G4-ET
			Open end, 4-wire	5 m	8040456	NEBC-LE4-ES-5-D12G4-ET
Plug socket for power supply						
	Socket, M12x1, 5-pin			18324	FBSD-GD-9-5POL	
Connecting cable for power supply						
	<ul style="list-style-type: none"> • Socket, M12x1, 5-pin • Plug, M12x1, 5-pin 	Suitable for chain link trunking	5 m	574321	NEBU-M12G5-E-5-Q8N-M12G5	
			7.5 m	574322	NEBU-M12G5-E-7.5-Q8N-M12G5	
			10 m	574323	NEBU-M12G5-E-10-Q8N-M12G5	
			Standard	0.5 m	570733	NEBU-M12W5-K-0.5-M12W5
					8003617	NEBU-M12G5-K-0.5-M12W5
				2 m	570734	NEBU-M12W5-K-2-M12W5
					8003618	NEBU-M12G5-K-2-M12W5

Fieldbus modules CTEU/Installation system CTEL

Technical data – Interface CPX-CTEL

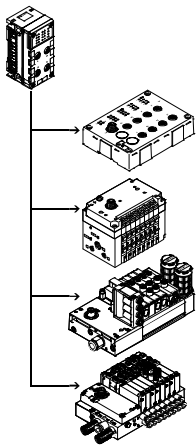

The electrical interface CPX-CTEL master establishes the connection to modules of the CTEU/CTEU series that have an I-Port interface (device). The I/O data from the connected devices are transmitted to the connected CPX bus node and thus to the higher-order controller via fieldbus. A maximum of 4 devices can be connected to a CPX CTEL Master via corresponding M12 interfaces.



Application

I-Port interface

As well as transmitting the communication data, the I-Port interfaces of a CPX-CTEL master also transmit the

power supply to the connected sensors and the load supply to the valves (or outputs). Both circuits are

supplied separately with 24 V, using a separate reference potential. The connecting cables used must meet

the enhanced requirements resulting from the dual function of signal cable and supply cable.

Configuration example – CPX-CTEL master with CTEU modules

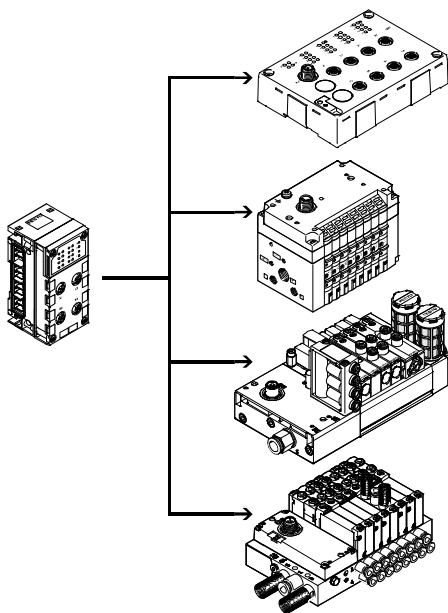

The CPX-CTEL master provides 4 external I-Port interfaces, each of which can be connected with a device. I-Port is an interface for exchanging serial data for connecting decentralised modules or valve terminals from Festo. The I-Port interface is based on IO-Link and is compatible with it in certain areas. The connection type corresponds to a star topology. In other words, only one module or valve terminal can be connected to each I-Port.

The restrictions compared to IO-Link include:

- Permanently set baud rate of 230.4 kbps
- SIO mode is not supported
- Max. 32 bytes of input data and 32 bytes of output data
- Only one dump of the master commands is used
- Festo plug & work principle, configuration via IO-DD is not supported.

Fieldbus modules CTEU/Installation system CTEL

Technical data – Interface CPX-CTEL



Implementation

<p>The CPX-CTEL master from Festo enables modules with an I-Port interface to be connected to a CPX system:</p> <ul style="list-style-type: none"> • A maximum of 4 devices with individual electronic fuse protection • A maximum of 64 inputs/ 64 outputs per I-Port interface • The maximum length of a string is 20 m 	<p>The following device variants are available:</p> <ul style="list-style-type: none"> • Input modules with 16 digital inputs (connection technology M8 3-pin and M12 5-pin) • Valve terminals with I-Port interface (up to 48 solenoid coils, different valve functions) 	<p>The decentralised arrangement of the modules and valve terminals with I-Port enables them to be mounted close to the cylinders and actuators or sensors to be controlled. This means that the compressed air supply lines and sensor cables used can be shortened, and it may be possible to use smaller valves, thereby saving costs.</p>	<p>Several CPX-CTEL masters can be combined in one CPX terminal, depending on the address capacity of the bus node.</p> <p>Example:</p> <ul style="list-style-type: none"> • CPX-FB13 (512 I/O) • A maximum of 2 CPX-CTEL masters is possible (each with 256 E/A)
--	---	---	---

Configuration

Settings	Manual configuration		Automatic configuration
<p>The precise number of the I/O bytes made available depends on the requirements of the connected devices or of the suitable selected operating mode.</p> <p>The operating mode or preset configuration of the CPX-CTEL master can be specified by the user.</p> <p>DIL switches are used for selecting the operating mode and setting the manual configuration. These DIL switches are not required during continuous operation and are only accessible in the disassembled state.</p>	<p>In the case of manual configuration (tool change mode), the volume of inputs and outputs in the process image of the CPX system or of the higher-level fieldbus can be defined manually using the DIL switches.</p>	<p>The process image then always has the same scope, regardless of the connected devices.</p> <p>The I/O length specified always applies to all four I-Ports (max. 8 bytes per I-Port).</p>	<p>In the case of automatic configuration, the I/O length for each I-Port is determined individually and this value is used to select the appropriate or next highest configuration preset.</p>

Power supply for I-Port devices

<p>The CPX-CTEL master provides two separate power supplies for the connected devices:</p> <ul style="list-style-type: none"> • For operating the device and the inputs connected to it • For the outputs and valves that are connected to the device 	<p>The power supply for the devices and the inputs is provided by the power supply for the electronics and sensors of the CPX terminal.</p> <p>The power supply for the outputs and valves is provided by the power supply</p>	<p>for the valves of the CPX terminal.</p> <p>The interlinking block with additional power supply ensures a separate voltage supply for the valves and outputs. This allows the supply voltage to</p>	<p>be disconnected separately.</p> <p>The valves and outputs of the connected I-Port devices can therefore be disconnected separately without disconnecting the devices.</p>
---	--	---	--

Fieldbus modules CTEU/Installation system CTEL

Technical data – Interface CPX-CTEL

General technical data			
Type		CPX-CTEL-4-M12-5POL	
Protocol		I-Port	
Maximum address capacity	Outputs	[bit]	256
	Inputs	[bit]	256
I-Port connection		4x socket M12, 5-pin, A-coded	
Number of I-Port interfaces		4	
Max. cable length		[m]	20
Internal cycle time		[ms]	1 per 8 bits of user data
Electrical isolation	Channel – channel		No
	Channel – internal bus		Yes, using an intermediate supply
LED displays		X1 ... 4 = status of the I-Port interface 1 ... 4 PS = Electronic supply PL = Load supply · 4 · = Module error	
Diagnostics		<ul style="list-style-type: none"> • Communication error • Short circuit module • Module-oriented diagnostics • Undervoltage 	
Parameterisation		<ul style="list-style-type: none"> • Diagnostic behaviour • Fail-safe mode per channel • Forcing per channel • Idle mode per channel • Module parameters • Tool change mode 	
Additional functions		Tool change mode	
Control elements		DIL switches	
Operating voltage	Nominal value		[V DC] 24 (polarity-safe)
	Permissible range		[V DC] 18 ... 30
	Power failure buffering		[ms] 10
Intrinsic current consumption at nominal operating voltage		[mA]	Typically 65
Max. power supply per channel		[A]	4x 1.6
Max. residual current of outputs per channel		[A]	4x 1.6
Degree of protection to EN 60529		IP65/IP67	
Temperature range	Operation		[°C] –5 ... +50
	Storage/transport		[°C] –20 ... +70
Materials		PA reinforced, PC	
Note on materials		RoHS compliant	
Grid dimension		[mm]	50
Dimensions (incl. interlinking block) W x L x H		[mm]	50 x 107 x 55
Product weight		[g]	110

 Note

Please observe the general limits and guidelines for the system when configuring the electrical modules.

Fieldbus modules CTEU/Installation system CTEL

Technical data – Interface CPX-CTEL

Connection and display components

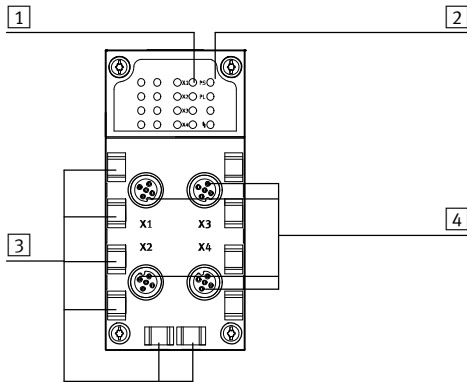

- 1 Status LEDs for I-Port interfaces
- 2 CPX-specific status LEDs
- 3 Holders for inscription labels (IBS 6x10)
- 4 I-Port interfaces for up to 4 devices

Pin allocation I-Port interface/IO-Link

	Pin	Allocation	Description
	1	24V _{EL} /SEN	Operating voltage supply (electronics, sensors/inputs)
	2	24V _{VAL} /OUT	Load voltage supply (valves/outputs)
	3	0V _{EL} /SEN	Operating voltage supply (electronics, sensors/inputs)
	4	C/Q	Data communication
	5	0V _{VAL} /OUT	Load voltage supply (valves/outputs)

Dimensions



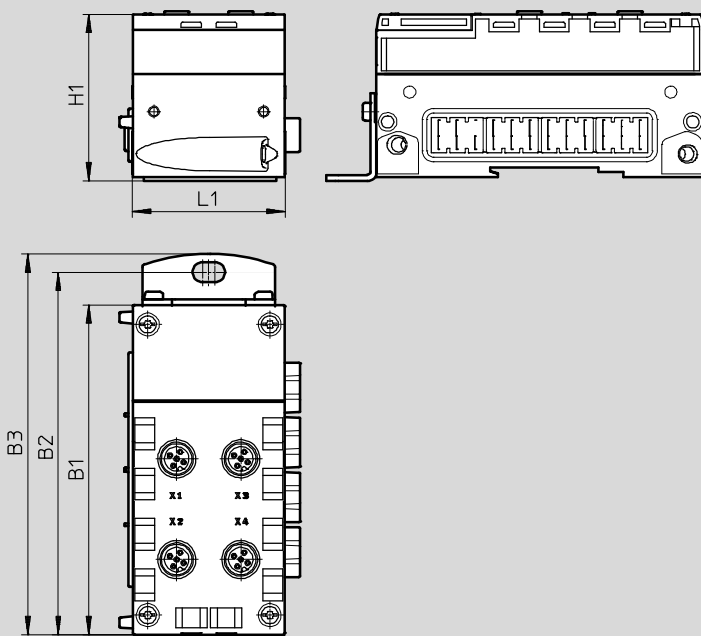

Download CAD data → www.festo.com

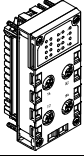

Type	B1	B2	B3	H1	L1
CPX-CTEL-4-M12-5POL	108.1	118.9	124.9	55.1	50

Fieldbus modules CTEU/Installation system CTEL

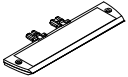
Accessories – Interface CPX-CTEL

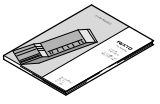
Ordering data					
Description				Part No.	Type
CPX-CTEL master					
	Interface for a maximum of 4 I/O modules and valve terminals with I-Port interface (devices)			1577012	CPX-CTEL-4-M12-5POL
Bus connection					
	Cover cap M12			165592	ISK-M12
	Inscription label holder for connection plate			536593	CPX-ST-1
Connecting cable					
	Straight - angled	Suitable for use with energy chains	5 m	574321	NEBU-M12G5-E-5-Q8N-M12G5
			7.5 m	574322	NEBU-M12G5-E-7.5-Q8N-M12G5
			10 m	574323	NEBU-M12G5-E-10-Q8N-M12G5
	Angled - angled	Standard	0.5 m	570733	NEBU-M12W5-K-0.5-M12W5
				8003617	NEBU-M12G5-K-0.5-M12W5
			2 m	570734	NEBU-M12W5-K-2-M12W5
8003618	NEBU-M12G5-K-2-M12W5				
User documentation					
	User documentation for CPX-CTEL master	German	574600	P.BE-CPX-CTEL-DE	
		English	574601	P.BE-CPX-CTEL-EN	
		Spanish	574602	P.BE-CPX-CTEL-ES	
		French	574603	P.BE-CPX-CTEL-FR	
		Italian	574604	P.BE-CPX-CTEL-IT	

Fieldbus modules CTEU/Installation system CTEL

Technical data – Interface CPX-CTEL-2

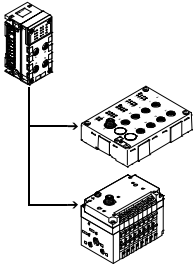

The electrical interface CPX-CTEL master establishes the connection to modules of the CTEL/CTEU series that have an I-Port interface (device). The I/O data from the connected devices are transmitted to the connected CPX bus node and thus to the higher-order controller via fieldbus. A maximum of two IO-Link devices can be connected to an electrical interface CPX-CTEL-2-... via corresponding M12 interfaces.



Application

IO-Link interface

The communication system IO-Link is used to exchange serial data from decentralised function modules (devices) at the field level.

The electrical interface CPX-CTEL-2-... provides two IO-Link interfaces, each

of which can be connected with a device. The connection type corresponds to a star topology, which means that only one device can be connected to each port.

The address space that the module makes available and assigns accordingly in the CPX system can be configured according to various presettings. Selection of the operating mode and

the setting for manual configuration takes place via the DIL switches. These DIL switches are not required during continuous operation and are only accessible in the disassembled state.

Restrictions

The interfaces (ports) of electrical interface CPX-CTEL-2-... support the connection of IO-Link devices with few limitations.

- The process data length of the inputs and outputs is limited to 16 bytes per port for inputs and outputs

- The driver strength on the C/Q line is limited to 250 mA

- SIO mode is not supported

Power supply for devices

The electrical interface CPX-CTEL-2-... provides two separate power supplies for the connected devices:

- For the operation of the device and the inputs connected to it
- For the outputs and valves that are connected to the device

The power supply for the devices and the inputs is provided by the power supply for the electronics and sensors of the CPX terminal. The power supply for the outputs and valves is provided by the power supply

for the valves of the CPX terminal. The interlinking block with additional power supply ensures a separate voltage supply for the valves and outputs. This allows the supply voltage to

be disconnected separately. The valves and outputs of the connected I-Port devices can therefore be disconnected separately without disconnecting the devices.

Fieldbus modules CTEU/Installation system CTEL

Technical data – Interface CPX-CTEL-2

General technical data			
Type	CPX-CTEL-2-M12-5POL-LK		
Protocol	IO-Link, master version V 1.0		
Max. address capacity	Outputs	[bit]	256
	Inputs	[bit]	256
I-Port connection	2x socket M12, 5-pin, A-coded		
Number of IO-Link interfaces	2		
Max. cable length			[m] 20
Internal cycle time			[ms] 1 per 8 bits of user data
Electrical isolation	Channel – channel		No
	Channel – internal bus		Yes, using an intermediate supply
LED displays	X1 ... 2 = status of the IO-Link interface 1 ... 2 PS = Electronic supply PL = Load supply · 4 · = Module error		
Diagnostics	<ul style="list-style-type: none"> • Communication error • Short circuit module • Module-oriented diagnostics • Undervoltage 		
Parameterisation	<ul style="list-style-type: none"> • Diagnostic behaviour • Fail-safe mode per channel • Forcing per channel • Idle mode per channel • Module parameters 		
Additional functions	–		
Control elements	DIL switches		
Operating voltage	Nominal value	[V DC]	24 (polarity-safe)
	Permissible range	[V DC]	18 ... 30
	Power failure buffering	[ms]	10
Intrinsic current consumption at nominal operating voltage			[mA] Typically 65
Max. power supply per channel			[A] 2x 1.6
Max. residual current of outputs per channel			[A] 2x 1.6
Degree of protection to EN 60529	IP65, IP67		
Temperature range	Operation		[°C] –5 ... +50
	Storage/transport		[°C] –20 ... +70
Materials	PA reinforced, PC		
Note on materials	RoHS compliant		
Grid dimension			[mm] 50
Dimensions (incl. interlinking block) W x L x H			[mm] 50 x 107 x 55
Product weight			[g] 110

 Note

Please observe the general limits and guidelines for the system when configuring the electrical modules.

Fieldbus modules CTEU/Installation system CTEL

Technical data – Interface CPX-CTEL-2

Connection and display components

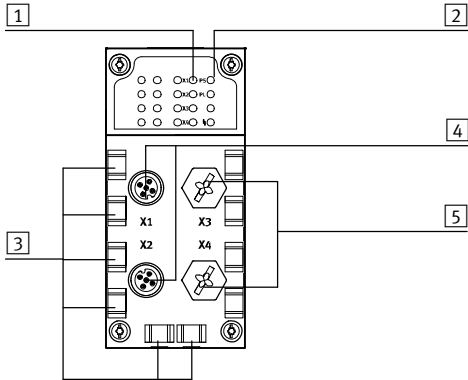

- 1 Status LEDs for I-Port interfaces
- 2 CPX-specific status LEDs
- 3 Holders for inscription labels (IBS 6x10)
- 4 IO-Link interfaces for up to 2 devices
- 5 Unoccupied connections

Pin allocation – IO-Link interface

Pin allocation	Pin	Signal	Designation
	1	24 V _{SEN}	24 V DC supply voltage for electronics and inputs
	2	24 V _{VAL}	24 V DC load voltage supply for valves and outputs
	3	0 V _{SEN}	0 V DC supply voltage for electronics and sensors
	4	C/Q I-PORT	Communication signal C/Q, data transmission line
	5	0 V _{VALVES}	0 V DC load voltage supply for valves and outputs

Dimensions



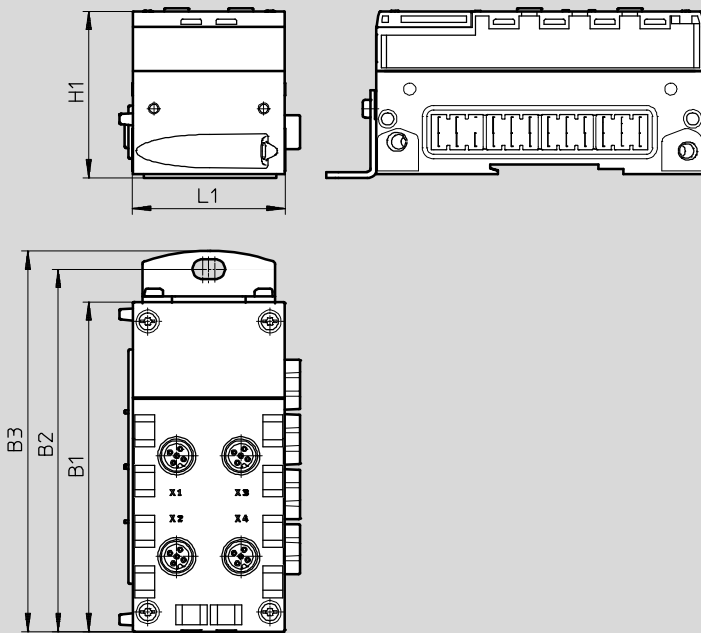

Download CAD data → www.festo.com



Type	B1	B2	B3	H1	L1
CPX-CTEL-2-M12-5POL-LK	108.1	118.9	124.9	55.1	50

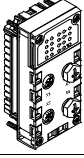

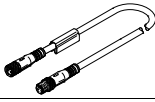
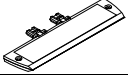
Fieldbus modules CTEU/Installation system CTEL

Accessories – Interface CPX-CTEL-2

Ordering data				
Description			Part No.	Type
CPX CTEL master, IO-Link				
	Interface for max. 2 I/O modules and valve terminals with IO-Link interface (devices)		2900543	CPX-CTEL-2-M12-5POL-LK
Bus connection				
	Cover cap	M12	165592	ISK-M12
	Connecting cable M12-M12, 5-pin, straight plug connector-straight socket	5 m	574321	NEBU-M12G5-E-5-Q8N-M12G5
		7.5 m	574322	NEBU-M12G5-E-7.5-Q8N-M12G5
		10 m	574323	NEBU-M12G5-E-10-Q8N-M12G5
	Inscription label holder for connection plate		536593	CPX-ST-1
User documentation				
	User documentation for CPX CTEL master	German	8034115	P.BE-CPX-CTEL-LK-DE
		English	8034116	P.BE-CPX-CTEL-LK-EN
		Spanish	8034117	P.BE-CPX-CTEL-LK-ES
		French	8034118	P.BE-CPX-CTEL-LK-FR
		Italian	8034119	P.BE-CPX-CTEL-LK-IT
		Swedish	8034120	P.BE-CPX-CTEL-LK-ZH

Fieldbus modules CTEU/Installation system CTCL

Technical data – Valve terminals CPV

-  Flow rate
CPV10: up to 400 l/min
CPV14: up to 800 l/min
-  Valve width
CPV10: 10 mm
CPV14: 14 mm
-  Voltage
24 V DC

I-Port interface for communication between a valve terminal CPV and an I-Port master. It activates a valve terminal CPV with up to 16 solenoid coils on max. 8 valve positions. The connection to a higher-order controller can be achieved by:

- Connection to an I-Port master from Festo (CPX-CTEL)
- Direct mounting of a bus node CTEU
- Connection to an IO-Link master (in IO-Link mode)



General technical data		
Protocol		IO-Link/I-Port
IO-Link	Connection technology	5-pin
	Protocol	V 1.0
	Communication mode	COM2 (38.4 kBaud), COM3 (230 kBaud)
	Port type	B
	Number of ports	1
	Process data width OUT [bit]	16
	Minimum cycle time [ms]	3.2
Baud rate	[kbps]	38.4/230.4
Maximum number of valve positions		8
Nominal operating voltage	[V DC]	24
Nominal load voltage	[V DC]	24
Operating voltage range	Electronics/sensors	[V DC] 18 ... 30
	Load voltage	[V DC] 21.6 ... 26.4
Intrinsic current consumption	Operating voltage	[mA] 35
	Load voltage	[mA] 700
Reverse polarity protection		For operating voltage
Diagnostics		Undervoltage in load voltage supply
LED display	Bus-specific	1 communication status
	Product-specific	16 valve status

Materials	
Cover	PA
Note on materials	RoHS compliant

Operating and environmental conditions		
Mounting position		Any
Degree of protection to EN 60529		IP65 (when fully plugged in or fitted with protective cover)
Ambient temperature	[°C]	-5 ... +50
Storage temperature	[°C]	-20 ... +70
Relative air humidity	[%]	93 (non-condensing)
CE marking (see declaration of conformity)		To EU EMC Directive ¹⁾

1) For information about the applicability of the component see the manufacturer's EC declaration of conformity at: www.festo.com/sp → Certificates.
If the component is subject to restrictions on usage in residential, office or commercial environments or small businesses, further measures to reduce the emitted interference may be necessary.

Fieldbus modules CTEU/Installation system CTEL

Technical data – Valve terminals CPV

Connection and display components

CPV10

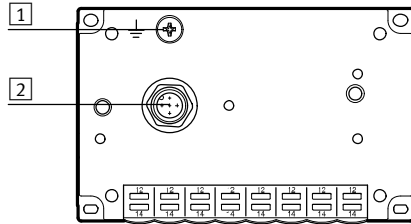

1 Earthing screw

2 I-Port interface/IO-Link

CPV14

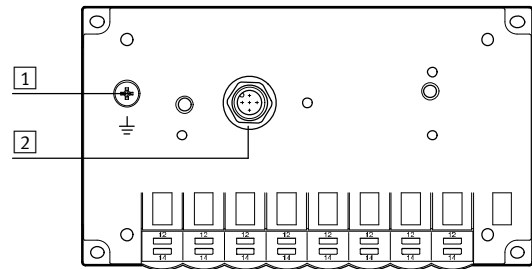

1 Earthing screw

2 I-Port interface/IO-Link

Pin allocation – I-Port interface/IO-Link

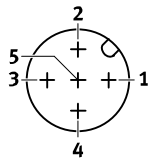

Pin	Allocation	Description
1	24V _{EL/SEN}	Operating voltage supply (electronics, sensors/inputs)
2	24V _{VAL/OUT}	Load voltage supply (valves/outputs)
3	0V _{EL/SEN}	Operating voltage supply (electronics, sensors/inputs)
4	C/Q	Data communication
5	0V _{VAL/OUT}	Load voltage supply (valves/outputs)

Dimensions

Download CAD data → www.festo.com

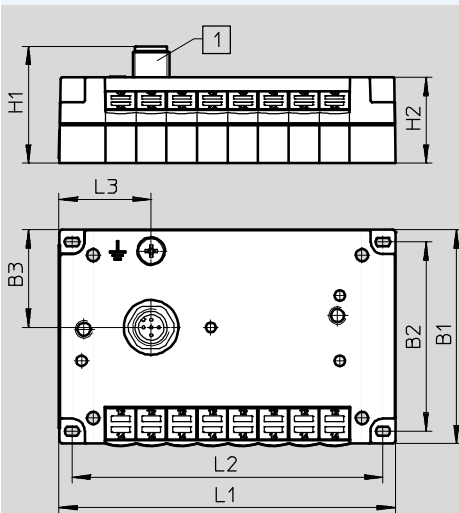





1 I-Port interface/IO-Link

Type	B1	B2	B3	H1	H2	L1	L2	L3
CPV10-GE-PT-8	71	62	32	38.3	26.2	110	101.8	30.2
CPV14-GE-PT-8	89	78	32.4	38.3	26.2	152	142	56.5

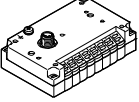
Fieldbus modules CTEU/Installation system CTEL

Accessories – Valve terminals CPV

Ordering data					Part No.	Type
I-Port bus node						
	Bus node with I-Port interface/IO-Link and 8 valve positions (maximum 8 double solenoid valves)	CPV10	Device ID: 0x 000410	108.5 g	1565761	CPV10-GE-PT-8
		CPV14	Device ID: 0x 000510	200 g	1564984	CPV14-GE-PT-8
Connection technology for IO-Link						
	T-adapter M12, 5-pin for IO-Link and load voltage supply				171175	FB-TA-M12-5POL
	Straight plug connector M12, 5-pin (for T-adapter)				175487	SEA-M12-5GS-PG7
Connecting cable						
	Straight - angled	Suitable for use with energy chains	5		574321	NEBU-M12G5-E-5-Q8N-M12G5
					574322	NEBU-M12G5-E-7.5-Q8N-M12G5
					574323	NEBU-M12G5-E-10-Q8N-M12G5
	Angled - angled	Standard	0.5 m		570733	NEBU-M12W5-K-0.5-M12W5
					8003617	NEBU-M12G5-K-0.5-M12W5
					570734	NEBU-M12W5-K-2-M12W5
Straight - angled			2 m	8003618	NEBU-M12G5-K-2-M12W5	

Fieldbus modules CTEU/Installation system CTEL

Technical data – Valve terminals MPA-L

-  Flow rate
 - VMPA1: up to 360 l/min
 - VMPA14: up to 670 l/min
 - VMPA2: up to 700 l/min

-  Valve width
 - VMPA1: 10 mm
 - VMPA14: 14 mm
 - VMPA2: 20 mm

-  Voltage
 - 24 V DC

I-Port interface for communication between a valve terminal MPA-L and an I-Port master. It activates a valve terminal MPA-L with up to 32 solenoid coils on max. 32 valve positions. The connection to a higher-order controller can be achieved by:

- Connection to an I-Port master from Festo (CPX-CTEL)
- Direct mounting of a bus node CTEU
- Connection to an IO-Link master (in IO-Link mode)

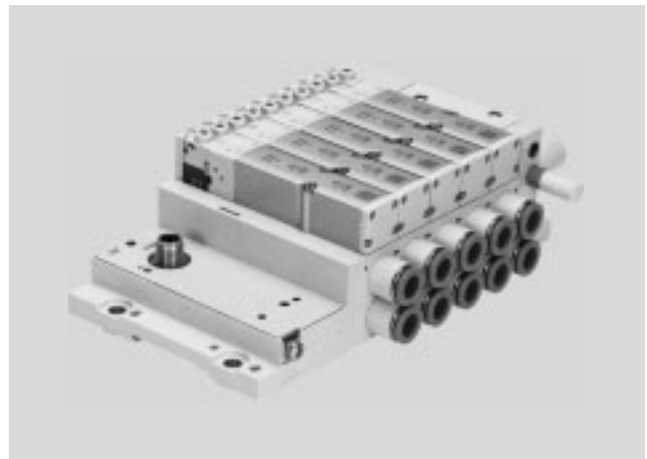

General technical data			
Protocol			IO-Link/I-Port
IO-Link	Connection technology		5-pin
	Protocol		V 1.0
	Communication mode		COM2 (38.4 kBaud), COM3 (230 kBaud)
	Port type		B
	Number of ports		1
	Process data width OUT	[bit]	8 ... 32
	Minimum cycle time	[ms]	3.2
Baud rate	[kbps]	38.4/230.4	
Operating pressure	[bar]	-0.9 ... 10	
Pilot pressure	[bar]	3 ... 8	
Nominal operating voltage	[V DC]	24	
Intrinsic current consumption	Operating voltage	[mA]	30
	Load voltage	[mA]	30
Reverse polarity protection			For operating voltage
Diagnostics			Undervoltage in load voltage supply
LED display			1 communication status

Materials	
End plate	PPA reinforced
Note on materials	RoHS compliant

Operating and environmental conditions	
Mounting position	Any
Ambient temperature	[°C] -5 ... +50
Storage temperature	[°C] -20 ... +40
Corrosion resistance class CRC ¹⁾	3

1) Corrosion resistance class 3 according to Festo standard 940 070
 Components subject to high corrosion stress. Externally visible parts with primarily functional surface requirements which are in direct contact with the surrounding industrial environment or media such as solvents and cleaning agents.

Fieldbus modules CTEU/Installation system CTEL

Technical data – Valve terminals MPA-L



Connection and display components

VMPAL-EPL-IPO32

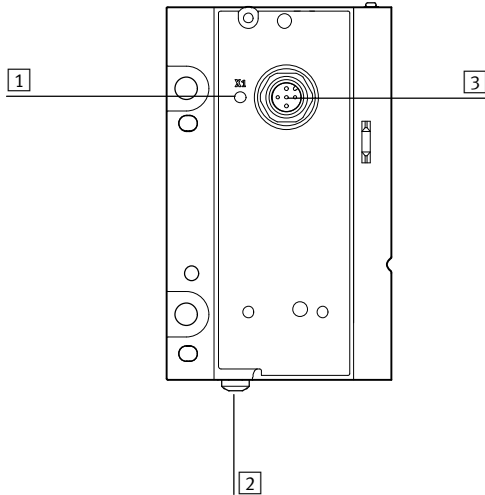

1 Status LED

2 Earthing screw

3 I-Port interface/IO-Link

Pin allocation I-Port interface/IO-Link

	Pin	Allocation	Description
	1	24V _{EL/SEN}	Operating voltage supply (electronics, sensors/inputs)
	2	24V _{VAL/OUT}	Load voltage supply (valves/outputs)
	3	0V _{EL/SEN}	Operating voltage supply (electronics, sensors/inputs)
	4	C/Q	Data communication
	5	0V _{VAL/OUT}	Load voltage supply (valves/outputs)

Dimensions

Download CAD data → www.festo.com

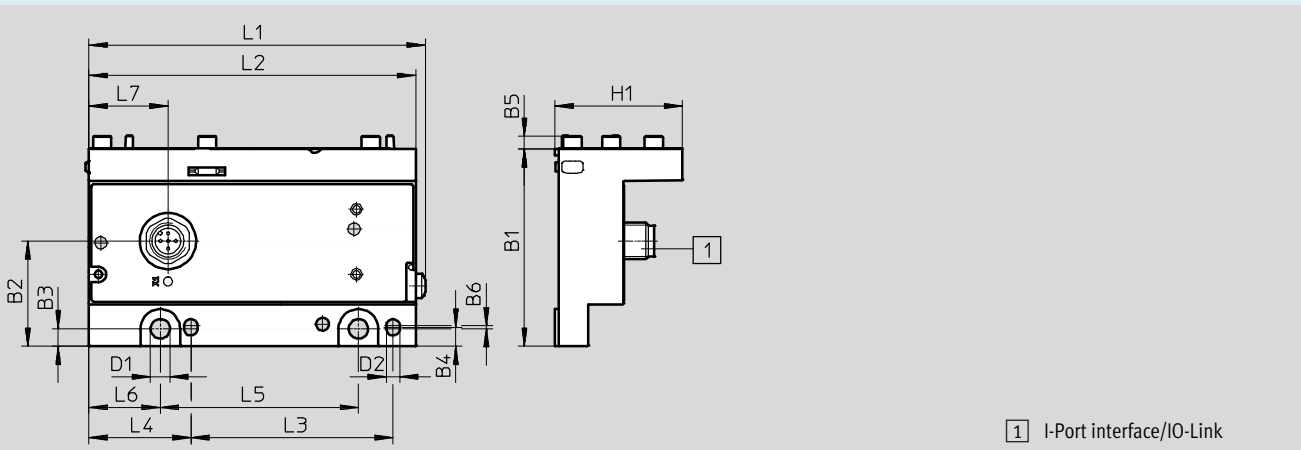





1 I-Port interface/IO-Link

Type	B1	B2	B3	B4	B5	B6	D1	D2	H1	L1	L2	L3	L4	L5	L6	L7
VMPAL-EPL-IPO32	64.8	34.5	5.7	6.2	4	1	6.4	4.5	41.8	110	107	66.3	33.5	65	23.5	26

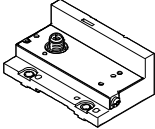
Fieldbus modules CTEU/Installation system CTEL

Accessories – Valve terminals MPA-L

Ordering data					
				Part No.	Type
I-Port bus node					
	Bus node with I-Port interface/IO-Link and up to 32 valve positions (maximum 16 double solenoid valves)	Device ID: 0x 000620	170 g	575667	VMPAL-EPL-IPO32
Connection technology for IO-Link					
	T-adapter M12, 5-pin for IO-Link and load voltage supply			171175	FB-TA-M12-5POL
	Straight plug connector M12, 5-pin (for T-adapter)			175487	SEA-M12-5GS-PG7
Connecting cable					
	Straight - angled	Suitable for use with energy chains	5 m	574321	NEBU-M12G5-E-5-Q8N-M12G5
			7.5 m	574322	NEBU-M12G5-E-7.5-Q8N-M12G5
			10 m	574323	NEBU-M12G5-E-10-Q8N-M12G5
	Angled - angled	Standard	0.5 m	570733	NEBU-M12W5-K-0.5-M12W5
				8003617	NEBU-M12G5-K-0.5-M12W5
			2 m	570734	NEBU-M12W5-K-2-M12W5
				8003618	NEBU-M12G5-K-2-M12W5

Fieldbus modules CTEU/Installation system CTEL

Technical data – Input modules CTSL

Function

Digital input modules facilitate the connection of proximity sensors or other 24 V DC sensors (inductive, capacitive, etc.). Plug connectors with double allocation are separated using a DUO plug connector or DUO cable.

Application

- Input modules for 24 V DC sensor signals
- M12 connection technology
- Display of the input statuses for each input signal via an assigned LED
- Operating voltage supply 24 V DC for all connected sensors
- Diagnostic LED for short circuit/overload of sensor supply
- Labelling options on all sides with large, hinged inscription label
- Earthing plate and H-rail mounting already integrated



General technical data			
Type		CTSL-D-16E-M8-3	CTSL-D-16E-M12-5
Electrical connection		16x socket M8, 3-pin	8x socket M12, 5-pin
Protocol		IO-Link/I-Port	
IO-Link	Connection technology		5-pin
	Protocol		V 1.0
	Communication mode		COM2 (38.4 kBaud), COM3 (230 kBaud)
	Port type		B
	Number of ports		1
	Process data width OUT	[bit]	16
	Minimum cycle time	[ms]	3.2
	Device ID	[ms]	0x 700410
Baud rate		[kbps]	38.4/230.4
Max. no. of inputs		16	
Nominal operating voltage		[V DC]	24
Operating voltage range		[V DC]	18 ... 30
Current consumption at nominal operating voltage of logic circuit		[mA]	Max. 35
Max. residual current per module		[mA]	1.2
Reverse polarity protection		For operating voltage	
Fuse protection (short circuit)		Internal electronic fuse protection for each group	
Electrical isolation between channels		No	
Switching level	Signal 0	[V]	≤5
	Signal 1	[V]	≥11
Input debounce time		[ms]	0.5 (3 ms, 10 ms, 20 ms parameterisable)
Input characteristic		IEC1131-T2	
Switching logic at inputs		PNP (positive switching)	
LED display	Bus-specific		X20: I-Port/IO-Link
	Product-specific		1 operating voltage
			16 channel status
		2 group diagnostics	

Fieldbus modules CTEU/Installation system CTSL

Technical data – Input modules CTSL

Materials		
Housing		PA reinforced
Cover		PA reinforced
Note on materials		RoHS compliant
Product weight	[g]	250
Dimensions	(W x L x H) [mm]	143 x 103 x 32

Operating and environmental conditions		
Type of mounting		Either via H-rail or via through-hole
Degree of protection to EN 60529		IP65/IP67 (when fully plugged in or fitted with protective cap)
Ambient temperature	[°C]	-5 ... +50
Storage temperature	[°C]	-20 ... +70
Corrosion resistance class CRC ¹⁾		2 ¹⁾
CE marking (see declaration of conformity)		To EU EMC Directive ²⁾
Approval certificate		C-Tick

- 1) Corrosion resistance class 2 according to Festo standard 940 070
Components subject to moderate corrosion stress. External visible parts with primarily decorative surface requirements which are in direct contact with the surrounding industrial environment or media such as coolants or lubricating agents.
- 2) For information about the applicability of the component see the manufacturer's EC declaration of conformity at: www.festo.com/sp → Certificates.
If the component is subject to restrictions on usage in residential, office or commercial environments or small businesses, further measures to reduce the emitted interference may be necessary.

Fieldbus modules CTEU/Installation system CTEL

Technical data – Input modules CTSL



Connection and display components

CTSL-D-16E-M8-3

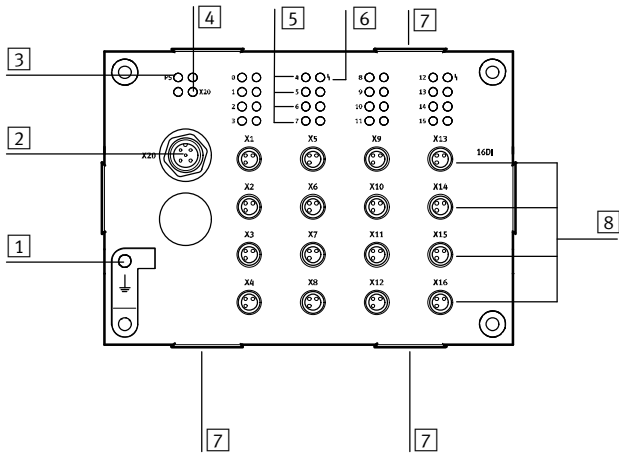

- 1 Earth terminal
- 2 I-Port interface/IO-Link
- 3 Status LED for power supply (PS)
- 4 Status LED for I-Port (X20)
- 5 Status-LEDs for inputs (status display, green)
- 6 Status LED (group) for short circuit/overload of sensor supply (red)
- 7 Fixture for inscription label holder ASCF-H-E2
- 8 Sensor connections (1 input per socket)

Pin allocation – I-Port interface/IO-Link

	Pin	Allocation	Description
	1	24V _{EL/SEN}	Operating voltage supply (electronics, sensors/inputs)
	2	–	–
	3	0V _{EL/SEN}	Operating voltage supply (electronics, sensors/inputs)
	4	C/Q	Data communication
	5	–	–

Pin allocation – Sensor connections CTSL-D-16E-M8-3

Pin allocation	Pin	Allocation	Description
	1	24V	Operating voltage 24 V
	3	0V	Operating voltage 0 V
	4	I _x *	Sensor signal

* I_x = Input x

Fieldbus modules CTEU/Installation system CTEL

Technical data – Input modules CTSL

Connection and display components

CTSL-D-16E-M12-5

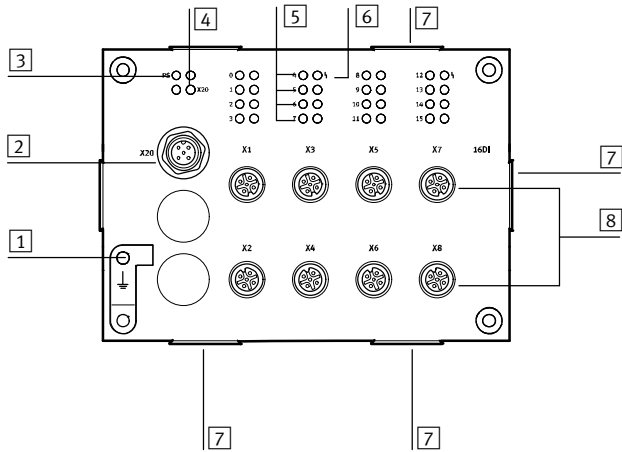

- 1 Earth terminal
- 2 I-Port interface/IO-Link
- 3 Status LED for power supply (PS)
- 4 Status LED for I-Port (X20)
- 5 Status-LEDs for inputs (status display, green)
- 6 Status LED (group) for short circuit/overload of sensor supply (red)
- 7 Fixture for inscription label holder ASCF-H-E2
- 8 Sensor connections (2 inputs per socket)

Pin allocation – I-Port interface/IO-Link

	Pin	Allocation	Description
	1	24V _{EL/SEN}	Operating voltage supply (electronics, sensors/inputs)
	2	–	–
	3	0V _{EL/SEN}	Operating voltage supply (electronics, sensors/inputs)
	4	C/Q	Data communication
	5	–	–

Pin allocation – Sensor connections CTSL-D-16E-M12-5

Pin allocation	Pin	Allocation	Description
	1	24V	Operating voltage 24 V
	2	I _{x+1} *	Sensor signal
	3	0V	Operating voltage 0 V
	4	I _x *	Sensor signal
	5	FE	Functional earth

* I_x = Input x

Fieldbus modules CTEU/Installation system CTEL

Technical data – Input modules CTSL

Dimensions

Download CAD data → www.festo.com

CTSL-D-16E-M8-3

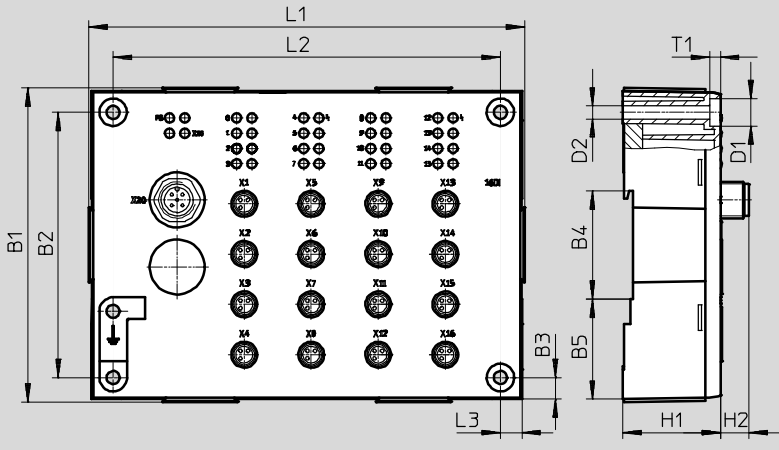



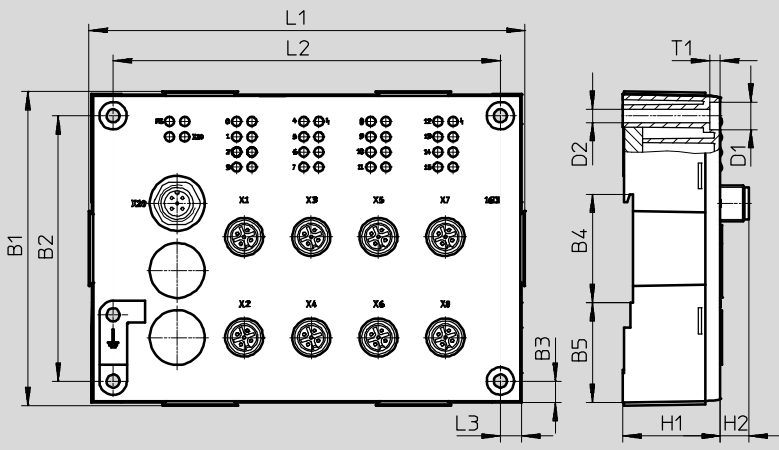

CTSL-D-16E-M12-5

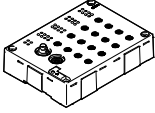

Type	B1	B2	B3	B4	B5	D1	D2	H1	H2	L1	L2	L3	T1
CTSL-D-16E	103	87	7	35.5	32.8	9	4.3	32	9.4	143	127	7	3.5

Fieldbus modules CTEU/Installation system CTSL

Accessories – Input modules CTSL

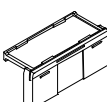
Ordering data				
Description			Part No.	Type
Input modules				
	16 sensor connections M8, 3-pin, single allocation		1387363	CTSL-D-16E-M8-3
	8 sensor connections M12, 5-pin, double allocation		1387359	CTSL-D-16E-M12-5
Plug connector				
	Straight plug connector, M12	5-pin, PG7	175487	SEA-M12-5GS-PG7
		4-pin, PG7	18666	SEA-GS-7
		4-pin, for cable diameter 2.5 mm ²	192008	SEA-4GS-7-2,5
	Straight plug connector, M8	3-pin, solderable	18696	SEA-GS-M8
		3-pin, screw-in	192009	SEA-3GS-M8-S
	Plug connector for 2 cables, M12, PG11	4-pin	18779	SEA-GS-11-DUO
		5-pin	192010	SEA-5GS-11-DUO
Connecting cables				
	Connecting cable, M12, 4-pin, straight plug connector - straight socket	2.5 m	539052	NEBU-M12G4-K-2.5-M12G4¹
		5.0 m	539052	NEBU-M12G4-K-5-M12G4¹
	Connecting cable, M8, 3-pin, straight plug connector - straight socket	0.5 m	539052	NEBU-M8G3-K-0.5-M8G3¹
		1 m	539052	NEBU-M8G3-K-1-M8G3¹
		2.5 m	539052	NEBU-M8G3-K-2.5-M8G3¹
		5 m	539052	NEBU-M8G3-K-5-M8G3¹
	Straight - angled	5 m	574321	NEBU-M12G5-E-5-Q8N-M12G5
		7 m	574322	NEBU-M12G5-E-7.5-Q8N-M12G5
		10 m	574323	NEBU-M12G5-E-10-Q8N-M12G5
	Angled - angled	0.5 m	570733	NEBU-M12W5-K-0.5-M12W5
	Straight - angled		8003617	NEBU-M12G5-K-0.5-M12W5
	Angled - angled	2 m	570734	NEBU-M12W5-K-2-M12W5
Straight - angled	8003618		NEBU-M12G5-K-2-M12W5	
Inscription label holder				
	Inscription label holders for EL modules, bag of 10		547473	ASCF-H-E2

1) Modular product, more information → Internet: nebu

Fieldbus modules CTEU/Installation system CTEL

Example of a valve terminal VTUG with I-Port interface

Dimensions – Example of a valve terminal with I-Port interface, size 10

Download CAD data → www.festo.com

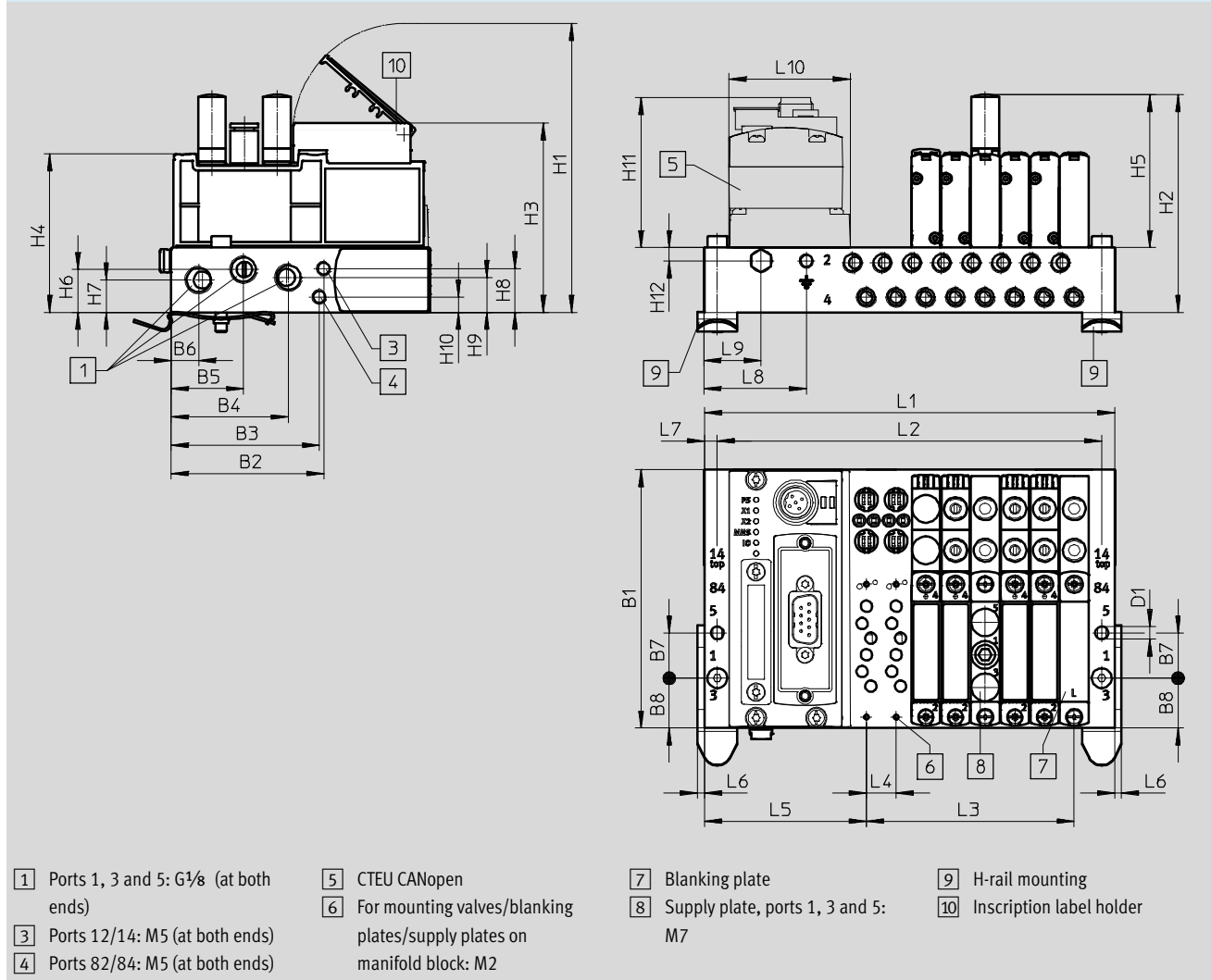

Fieldbus modules CTEU/Installation system CTEL

Example of a valve terminal VTUG with I-Port interface

Type	No. of valve positions	Size 10																
		B1	B2	B3	B4	B5	B6	B7	B8	D1 Ø	H1	H2	H3	H4	H5	H6	H7	H8
VABM	4-24	91.5	54	52.4	41.5	25.6	9.8	16	17.7	4.5	102.3	77.1	67	56.1	54.1	15.2	11.5	15.5

Type	No. of valve positions	Size 10										
		H9	H10	H11	H12	L4	L5	L6	L7	L8	L9	L10
VABM	4-24	12.4	5.5	54.8	4.8	10.5	57.3	2.5	4.5	36	20	42.5

Type	No. of valve positions	Size 10		
		L1	L2	L3
VABM	4	103	94	31.5
	5	113.5	104.5	42
	6	124	115	52.5
	7	134.5	125.5	63
	8	145	136	73.5
	9	155.5	146.5	84
	10	166	157	94.5
	12	187	178	115.5
	16	229	220	157.5
	20	271	262	199.5
24	313	304	241.5	