

PMV D3 Digital Positioner





D3 Digital Positioner

General

The PMV D3 from Flowserve is a digital valve positioner with an exceptional set of features and benefits.

It's extremely simple to use due to five configuration buttons and a large, clear graphic display.

The zero bleed pneumatic relay produces operational cost savings due to the unit's very low air consumption.

Optional plug-in modules offer limit switches (mechanical, proximity and P+F inductive), 4–20 mA feedback and alarm with output function.

Communication options include HART®, Profibus PA and DP, Foundation Fieldbus and Wireless ISA100 (see opposite).

Advanced valve diagnostics including functionality for running scheduled or manual partial strokes (PST) is available with the optional ValveSight™ package.

IP66/NEMA 4X

The strong, die-cast housing is treated with a powder epoxy, protecting the unit from corrosion and mechanical damage.

Additionally, the uniquely designed strut on the cover protects the graphic display.

The screw terminals for the electrical connections are located in an isolated and sealed housing to protect the electronic components should moisture enter via the conduit.

Wireless Communication

The D3 is one of the world's first positioners to employ wireless communication for modulating control and monitoring valves.

The new wireless positioner reduces the cost of extensive and expensive wiring and cabinets, while eliminating issues due to damaged/ageing wires and corroding connectors throughout the plant.

This industry-leading technology improves operational awareness by providing a highly flexible communication structure with virtually no restrictions on where the D3 positioner - and any process control / monitoring equipment with which it communicates - are sited.

Operating on the ISA100 Wireless™ standard the D3 complies with US, Canadian and Japanese radio regulations (FCC, IC and Japan Radio Law / UL). Approval in other regions is in progress.

Combined with the Flowserve ValveSight advanced predictive plant diagnostics system, it provides information on designated devices allowing informed decisions to be made on how to operate more efficiently – wherever those devices are located.

Easy installation

Installation is simple and quick with split spindle design, a friction coupling for the feedback sensor and a wide range of mounting kits designed to fit the majority of actuators on the market. The D3 is not orientation sensitive and mounts on both rotary and linear actuators.

D3 Intrinsically Safe



D3 Explosion Proof



Feedback and Remote mount

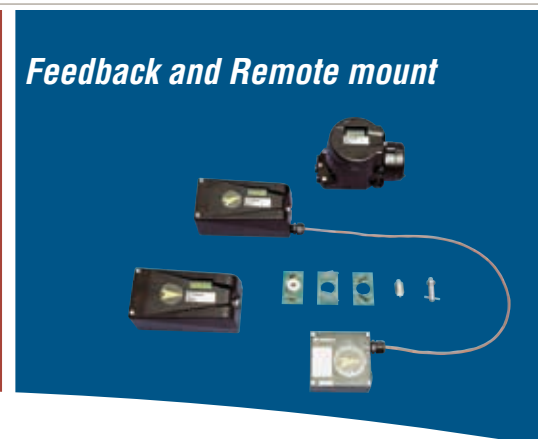

Versions/Options

D3 Intrinsically Safe

The D3 is available in an intrinsically safe version for installation in hazardous areas. It features the same easy-to-use user interface for local configuration as the standard D3. Communication via HART, Profibus PA or Foundation Fieldbus is possible. The IS version features all the benefits and options similar to the standard D3 positioner (gauge block, local graphic LCD display, and feedback option etc).

D3 Explosion Proof

The D3 digital positioner is also available in an explosion proof enclosure, featuring the same easy-to-use user interface for local configuration as the standard D3. Communication via HART®, Profibus PA and DP, Foundation Fieldbus and Wireless ISA100™ is possible.

Additional features include gauge ports and a local graphic LCD display.

D3 Remote Mounted

The D3 with remote mount is suitable for installations in severe applications, e.g. heavy vibrations, high or low temperatures, corrosive environments or areas of difficult access.

A flat or dome style indicator can be fitted on the feedback box installed on the actuator. The maximum recommended distance between the D3 and the remote unit is 5m.

D3 270° Rotation

The D3 provides up to 270° rotation for extended travel range. All PMV D3 versions are available with this 270° option.

D3 SIL 2

For critical applications the D3 is available in versions suitable for SIL (Safety Integrity Level) 2.

Feedback + Alarm plug in module

Optional plug-in feedback modules offer limit switch function; select between mechanical or proximity SPDT switches or P+F inductive sensors.

A 4-20 mA position feedback sensor is available as well as an alarm function for deviation, limit and temperature.



Fail Freeze

This special version offers the unique feature where, upon loss of input signal, the D3 will stay in its last position, an important function for dampers or other critical applications.

Pressure sensors

Optional on-board pressure sensors on the D3 offer you the possibility to utilize the full power of Flowserve's ValveSight diagnostic software.



Local User Interface

A large graphic display and five keys make the D3 simple to operate with all information presented clearly in text form in the display (the display being visible with the cover fitted).

There are no LEDs or cryptic codes on the display – navigation is intuitive and user-friendly.

During calibration and initialization, D3 guides you through how to set actuator type and function. Having selected the proper setting, simply press OK and the D3 will auto-calibrate itself for optimal function.

1. **Out of Service** – Cancels set-point and allows changes to positioner parameters.
2. **Manual** – Allows for manual selection of set-point or jog of the valve.
3. **Unprotected** – The positioner is not write protected. All settings can be overwritten.
4. **Heading Position** – Indicates the position of the displayed heading within a level.
5. **OK** – Confirms choices or changes of parameters. Acts as an “Enter” key.
6. **Up and Down buttons** – To scroll menus, enter values and operate the valve in manual mode.
7. **Esc** – Escapes the menu level without any unconfirmed changes.
8. **Func** – Used to select a heading or function. Press the FUNC-key to enable editing of parameters.



PC Configurator

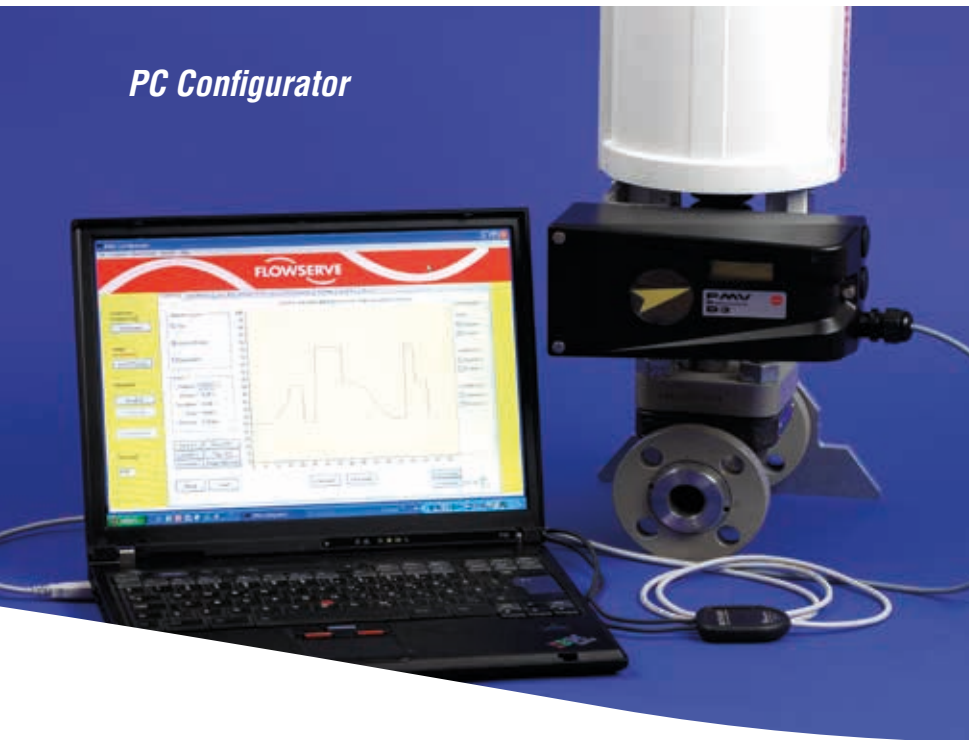

Stainless steel



PC Configurator

A PC configurator is available to connect your D3 with a computer. All that is required is a HART® modem and a D3 with HART® option. The PC configurator is available free of charge.

Communication

The D3 is available with HART®, Profibus PA & DP or Foundation Fieldbus protocol for bi-directional communication, enabling remote configuration and installation from a PC or handheld communicator. Drivers are available for AMS software.

The new Wireless ISA100™ communication for modulating and On / Off control, plus monitoring of valves, simplifies commissioning and set-up configurations by providing a flexible system which can be upgraded or modified by a computer in the control room rather than through expensive re-wiring of the plant. The communication uses safety features such as dual backbone routers to provide redundant radio paths and additionally incorporates safety features such as user configurable behavior at loss of signal or power from the plant. It is ideal for controlling and monitoring remotely located valves and for plants spread out over large areas.

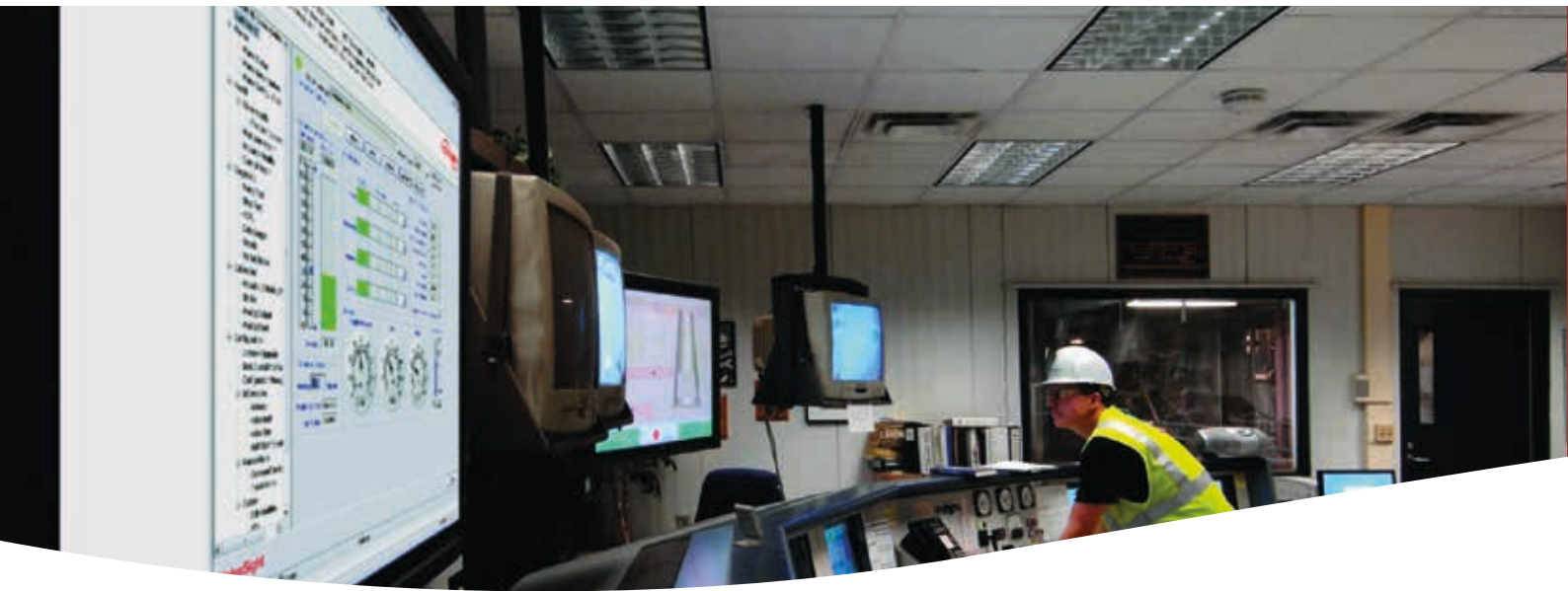

ValveSight - Unique Diagnostic Capability

The PMV D3 digital positioner with optional on-board pressure sensors and ValveSight software offers a powerful tool for control valve diagnostics.

The dashboard provides you with full information on the health status of the valve and possible upcoming issues.

Open standards

As ValveSight is based on open standards for integration and inter-operability from the FDT Group, it will work with any FDT/DTM-compliant host or asset management solution.

ValveSight has also been exhaustively tested with major host providers. Designed to work over a variety of protocols it has received independent certification from the relative standards associations for each. ValveSight is currently available for HART, Profibus PA and Foundation Fieldbus communication.

Retrofittable

Using the Flowserve D3 digital positioner and the wide range of mounting brackets and hardware, the D3 with ValveSight can be retrofitted in almost any application.

Unique Graphical User Interface (GUI)

ValveSight allows users of all levels of experience to use the system – whatever the type of control valve.

The ValveSight software uses a dashboard-like interface that does not require the user to navigate alarms in order to understand the health of the device. It has been specially designed to communicate complex information simply and quickly.



Powerful, but Easy to Use.

ValveSight was designed with operators in mind. The graphical user interface offers the following features:

- Intuitive navigation between functions
- Easily understandable names for views and parameters
- Online self-contained help functions and manuals to speed up the maintenance and repair process
- A common look and feel between different types of control valves and systems

Thanks to ValveSight's color-coded health status indication, it is easy to check the four key health parameters on the main dashboard: Green = normal; Yellow = warning; Red = alarm. The yellow bar displays varying stages or degrees on which the warning and alarm reports are based.

The screenshot shows the ValveSight software interface. On the left is a tree view with categories like 'Dashboard', 'Alarms', 'Diagnose', 'Calibration', and 'Configuration'. The main area displays a 'DASHBOARD' with several gauges and indicators. A 'Health Status' table is highlighted in the foreground, showing the status of four components: Valve, Positioner, Actuator, and Control. Each component has a green bar indicating 'Normal' status.

Health Status	Normal	Warning	Alarm
Valve:	██████████	██████████	██████████
Positioner:	██████████	██████████	██████████
Actuator:	██████████	██████████	██████████
Control:	██████████	██████████	██████████

ValveSight provides at-a-glance understanding of asset health – not only alarms.

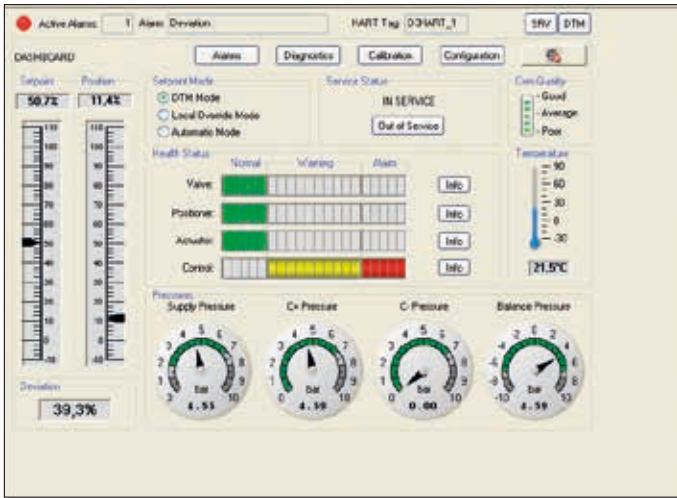

A glance at the dashboard gives all necessary information.

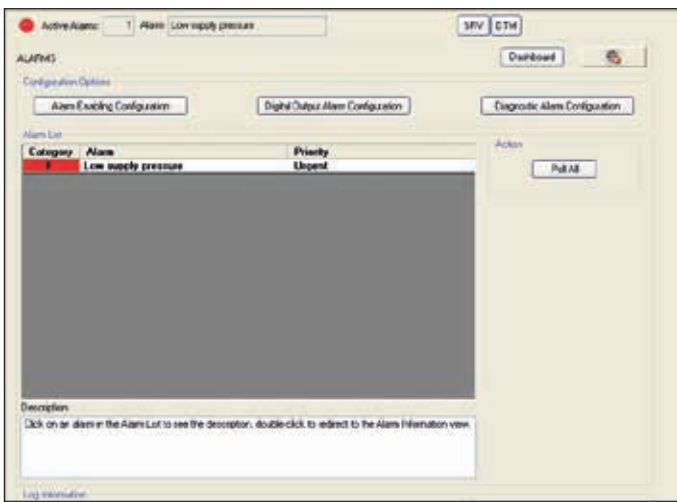

Alarms are clearly indicated.

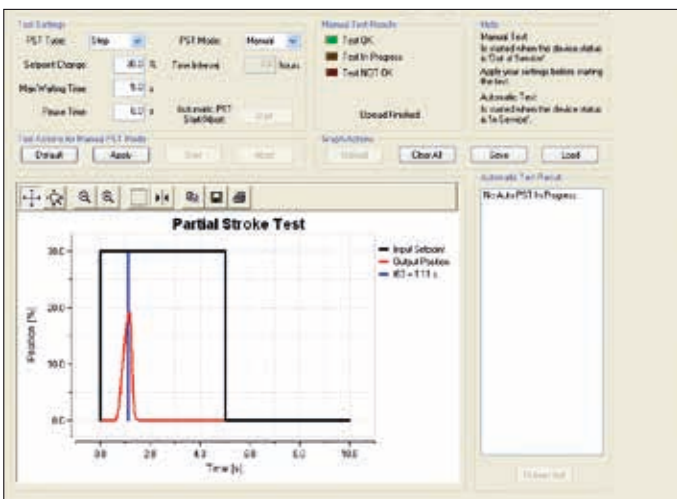

D3 and ValveSight allows "Partial Stroke Tests" to be performed and recorded.

ValveSight Is Compatible with Most Hosts

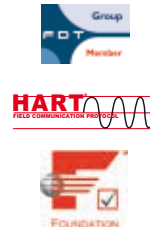

Open Standards-based Integration



Host Control Certification



Asset Management Integration



Interoperability

D3 Dimensional Drawings

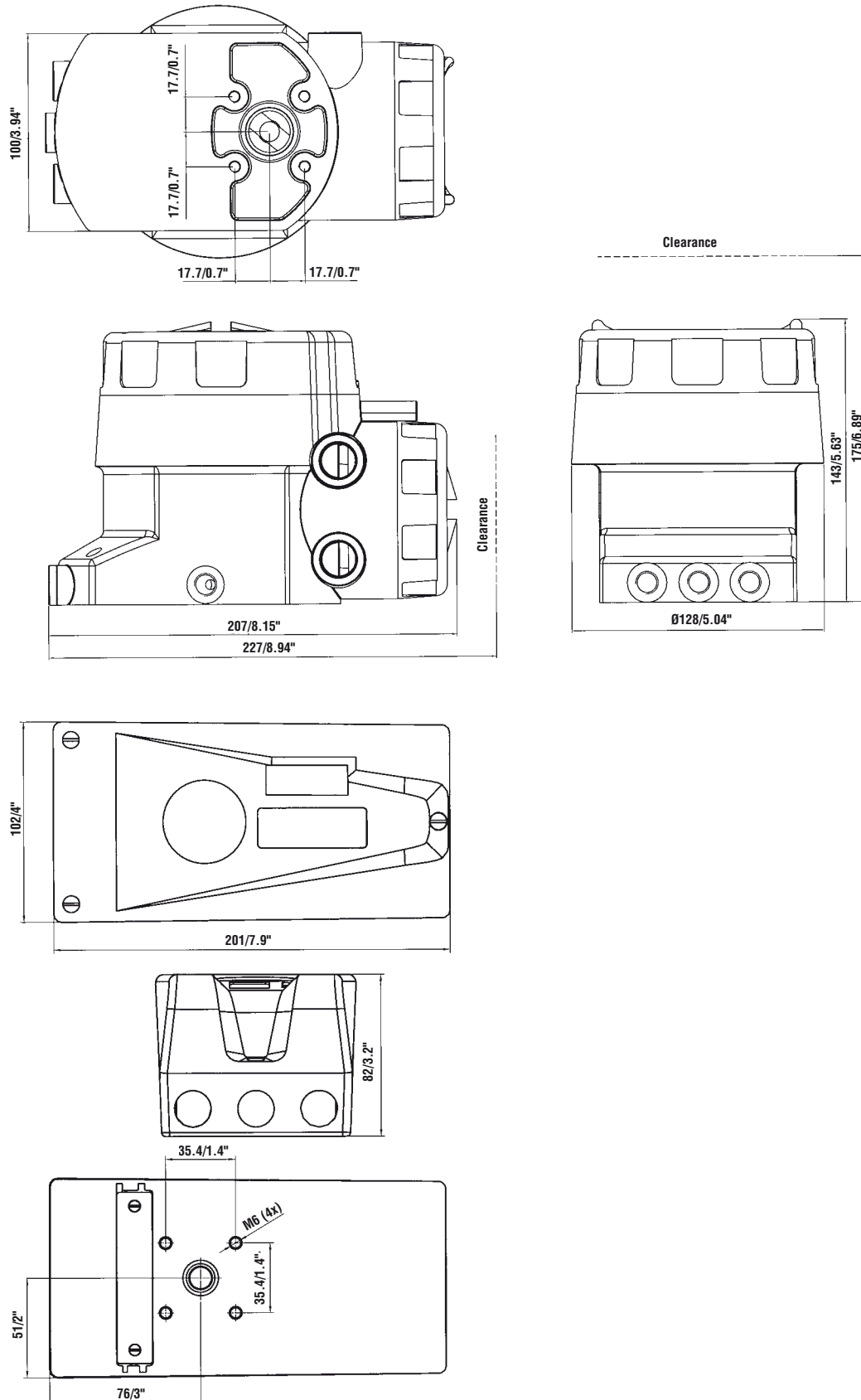



D3 Digital Positioner

Rotation angle	Min. 30° max. 100°, optional 270°
Stroke	5–130 mm (0.2" to 5.1")
Input signal	4–20 mA
Air supply	2–7 bar (30–105 Psi) Free from oil, water and moisture, filtered to min. 30 micron
Air delivery	350 nl/min (12 scfm)
Air consumption	<0.3 nl/min (0.01 scfm)
Air connections	1/4" G or NPT
Cable entry	3 x M20 x 1.5 or 1/2" NPT
Electrical connections	Screw terminals 2.5 mm ² /AWG14
Linearity	<1%
Repeatability	<0.5%
Hysteresis	<0.4%
Dead band	0.2–10% adjustable
Display	Graphic, view area 15 x 41 mm (0.6 x 1.6")
UI	5 push buttons
Processor	16 bit, M16C / ARM
CE directives	93/68EEC, 89/336/EEC, 92/31/EEC
EMC	EN 50 081–2, EN 50 082–2
Voltage drop	8 V (400 Ohm) non-Hart, 9,4 V (470) Ohm Hart
Vibrations	<1% up to 10g at frequency 10–500 Hz
Enclosure	IP66/ NEMA 4X
Material	Die-cast aluminum, A2/A4 fasteners
Surface treatment	Powder epoxy
Temperature range	–40°C to +80°C (–22°F to +176°F)
Weight	D3X, 1.4 kg (3 lbs) – D3E, 3 kg (6.6 lbs)
Mounting position	Any

Optional plug-in module

Mechanical Switches	
Type	SPDT
Size	Sub Sub miniature
Rating	100 mA/ 30 V DC/ 42 V AC
Namur Sensors	
Type	Proximity DIN 19234 NAMUR
Load Current	1 mA ≤ I _L ≤ 3 mA
Voltage range	8V DC
Hysteresis	0,2%
Temperature Range	–20°C to +85°C (–4°F to +185°F)
Proximity Switches	
Type	SPDT
Rating	100 mA/ 30 V DC/ 42 V AC
Operating time	0,7 ms
Breakdown voltage	200 V DC
Contact resistance	0,1Ω
Mechanical/electrical life	> 50x10 ⁶ operations
4–20 mA Transmitter	
Supply	13–28 V DC
Output	4–20 mA
Resolution	0.1%
Linearity full span	+/- 0,5%
Output current limit	30 mA DC
Load impedance	800Ω @ 24 V DC
Alarm output	
Alarm output	Transistor Ri 1KΩ
Alarm Supply Voltage	8–28 V

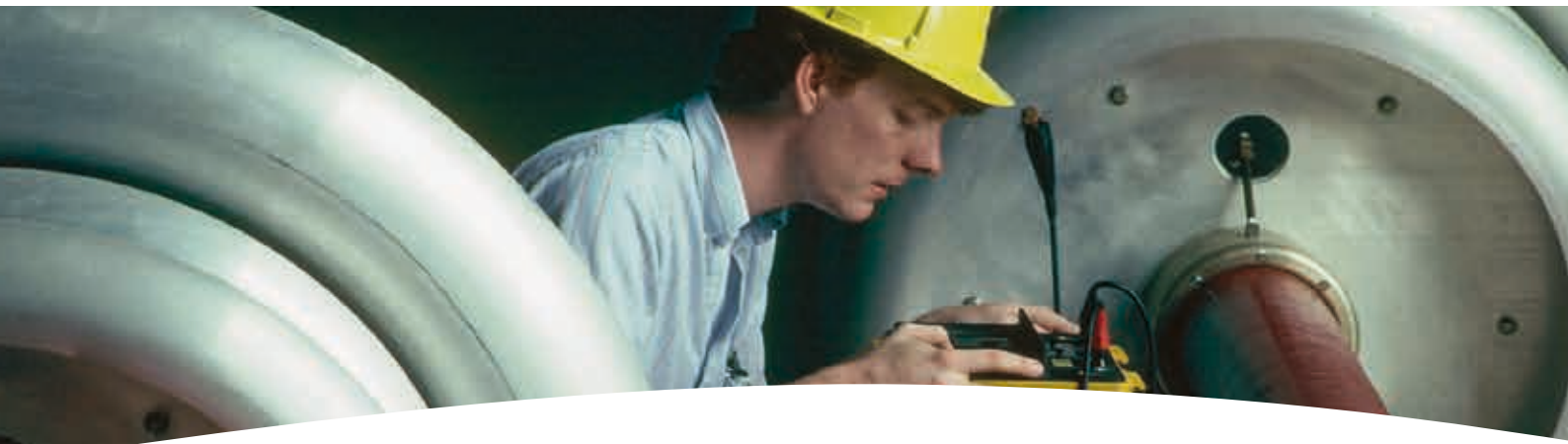

D3 Series Coding

Model no

- D3X Digital positioner with display and indicator, General purpose
- D3I Digital positioner with display and indicator, Intrinsically safe ATEX
- D3E Digital positioner with display, no indicator, Explosion proof ATEX, CSA/FM
- D3F Digital positioner with display, Explosion proof ATEX, CSA/FM, Direct mount to FlowAct

Connections

- G ¼" G air, 3 pcs M20 x 1,5 electrical
- N ¼" NPT air, 1/2" NPT electrical
- M ¼" NPT air, M20 x 1,5 electrical

Surface treatment

- U Powder epoxy
- E Stainless Steel enclosure (only for D3E & D3F)

Function

- S Single acting
- L Single acting, Fail Freeze
- P Single acting, Fail freeze remote mounted
- M Single acting, remote mounted
- D Double acting acting
- K Double acting Fail Freeze function
- Q Double acting Fail freeze remote mounted
- R Double acting Remote mounted

Spindle

- 23 Rotary VDI/VDE 3845
- 39 D type for linear & NAF
- 09 Double D type and adaptor

Cover and Indicator (No indicator on D3E, D3F)

- PVA Black PMV, 90 deg, Arrow indicator
- PVB Black, Extended travel, 270 deg Arrow indicator

Sensors/Temperature/Seals

- Z No pressure sensors, NBR -40 to +80°C
- Y On Board pressure sensors, NBR -40 to +80°C

Input signal/Protocol

- 4 4-20 mA
- 5 HART, 4-20 mA
- P Profibus PA
- F Foundation Fieldbus

Feedback option

- X No feedback option
- T* 4-20 mA transmitter only + Alarm
- S* Limit switches MEC + 4-20 mA + Alarm
- N* Limit sensors NAM + 4-20 mA + Alarm
- P* Limit switches PXY + 4-20 mA + Alarm
- 4* Slot type Namur sensor, P+F SJ2 S1N + Alarm
- 5* Slot type Namur sensor, P+F SJ2 SN + Alarm
- 6* Slot type Namur sensor, P+F SJ2N + Alarm

Accessories

- X No accessories
- M Gauge block (For D3X, D3I only, built in on D3E, D3F)

D	3			U	-						-	Z		
---	---	--	--	---	---	--	--	--	--	--	---	---	--	--

* Not for D3E, D3F

Contact PMV to learn about available SIL 2, Profibus DP and Wireless versions.



FCD PMENBR0001-04-A4 07/15



Hazardous Locations  

Intrinsically safe: ATEX EEX ia IIC T4  II 1 G D
Explosion proof: ATEX EEX d IIB-H₂ T6  II 2 G D
 CSA, FM Div.1, Class 1 Group B,C,D,
 Class II Group E,F,G, Class III

Flowserve Corporation has established industry leadership in the design and manufacture of its products. When properly selected, this Flowserve product is designed to perform its intended function safely during its useful life. However, the purchaser or user of Flowserve products should be aware that Flowserve products might be used in numerous applications under a wide variety of industrial service conditions. Although Flowserve can (and often does) provide general guidelines, it cannot provide specific data and warnings for all possible applications. The purchaser/user must therefore assume the ultimate responsibility for the proper sizing and selection, installation, operation, and maintenance of Flowserve products. The purchaser/user should read and understand the Installation and Maintenance (I & M) instructions included with the product, and train its employees and contractors in the safe use of Flowserve products in connection with the specific application.

While the information and specifications contained in this literature are believed to be accurate, they are supplied for informative purposes only and should not be considered certified or as a guarantee of satisfactory results by reliance thereon. Nothing contained herein is to be construed as a warranty or guarantee, express or implied, regarding any matter with respect to this product. Because Flowserve is continually improving and upgrading its product design, the specifications, dimensions and information contained herein are subject to change without notice. Should any question arise concerning these provisions, the purchaser/user should contact Flowserve Corporation at any one of its worldwide operations or offices.

©2008 Flowserve Corporation, Irving, Texas, USA. Flowserve and PMV are registered trademarks of Flowserve Corporation.

Palmstierna International AB
 Korta Gatan 9
 SE-171 54 Solna
 SWEDEN
 Tel: +46 (0) 8 555 106 00
 Fax: +46 (0) 8 555 106 01
 E-mail: infopmv@flowserve.com

Germany
 Flowserve Flow Control GmbH
 Rudolf-Plank Strasse 2
 D-76275 Ettlingen
 Germany
 Tel: +49 (0) 7243 103 0
 Fax: +49 (0) 7243 193 222
 E-mail: argus@flowserve.com

UK
 Flowserve Flow Control UK
 44 Victoria Way, Burgess Hill
 West Sussex, RH15 9NF
 UNITED KINGDOM
 Tel: +44 (0) 1444 884846
 E-mail: pmvuksales@flowserve.com

Italy
 Flowserve Spa
 Via Prealpi, 30
 20032 Cormano (Milano)
 ITALY
 Tel: +39 (0) 2 663 251
 Fax: +39 (0) 2 615 18 63
 E-mail: infoitaly@flowserve.com

USA, Mexico
 PMV-USA
 14219 Westfair West Drive
 Houston, TX 77041
 USA
 Tel: +1 281 671 9209
 Fax: +1 281 671 9268
 E-mail: pmvusa@flowserve.com

Canada
 Cancoppas Limited
 2595 Dunwin Drive, Unit 2
 Mississauga, Ont L5L 3N9
 CANADA
 Tel: +1 905 569 6246
 Fax: +1 905 569 6244
 E-mail: controls@cancoppas.com

Asia Pacific Headquarters
 Flowserve Pte Ltd.
 No. 12 Tuas Avenue 20
 REPUBLIC OF SINGAPORE 638824
 Tel: +65 (0) 687 98900
 Fax: +65 (0) 686 24940
 E-mail: fcdasiaprocess@flowserve.com

South Africa
 Flowserve
 Unit 1, 12 Director Road
 Spartan Ext. 2
 1613 Kempton Park, Gauteng
 SOUTH AFRICA
 Tel: +27 (0) 11 397 3150
 Fax: +27 (0) 11 397 5300

The Netherlands
 Flowserve Flow Control Benelux
 Rechtzaad 17
 4703 RC Roosendaal
 THE NETHERLANDS
 Tel: +31 (0) 30 6771946
 Fax: +27 (0) 30 6772471
 E-mail: fcbinfo@flowserve.com

China
 Flowserve
 Hanwei Building
 No. 7 Guanghua Road
 Chao Yang District
 100004 Beijing
 CHINA
 Tel: +86 (10) 6561 1900
 Fax: +86 (10) 6561 1899
 E-mail: mjiang@flowserve.com