

# Servo motors EMME-AS

**FESTO**



Festo core product range  
Covers 80% of your automation tasks

Worldwide:

Always in stock

Superb:

Festo quality at an attractive price

Easy:

Reduces procurement and storing complexity

★ Ready for dispatch from the Festo factory in 24 hours  
Held in stock in 13 service centres worldwide  
More than 2200 products

★ Ready for dispatch in 5 days maximum from stock  
Assembled for you in 4 service centres worldwide  
Up to  $6 \times 10^{12}$  variants per product series

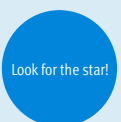

# Servo motors EMME-AS

Key features

FESTO

## Everything from a single source

Motors EMME-AS

→ page 3



- Brushless, permanently excited synchronous servo motors
- Reliable, dynamic, precise
- Digital absolute displacement encoder; choose from:
  - Single-turn
  - Multi-turn
  - Multi-turn with SIL2
- Optimised connection technology
- Winding variants
  - For single-phase motor controller
  - For three-phase motor controller
  - Speed-optimised
- Degree of protection: IP21 (motor shaft)
- Degree of protection: IP65 (motor housing incl. connection technology)
- Optional:
  - Holding brake

## Gear units EMGA-EAS/-SAS

→ page 17



- Low-backlash planetary gear unit
- Gear ratio  $i = 3$  and  $5$ , available ex-stock
- Life-time lubrication
- Protection class: IP54
- Other gear unit types, ratios, designs and versions on request

## Motor controllers CMMP-AS

→ Internet: cmm



- Digital servo controller (0.5 kVA ... 18 kVA)
- Actuation of AC servo and linear motors
- Integrated EMC filters
- Integrated brake chopper
- Integrated safety functions
- Position controller with closed-loop position control (256 position sets)
- Speed controller
- Torque control via current controller
- Range of control functions
- Interfaces:
  - I/O interface
  - CANopen, standard
  - PROFIBUS DP, optional module
  - DeviceNet, optional module
  - PROFINET RT, optional module
  - EtherCAT, optional module
  - EtherNet/IP, optional module

## Motor and encoder cables NEBM

→ page 19



- Suitable for use with energy chains
- Connection technology on motor side with protection to IP65
- Can be used in a wide temperature range

## EMC filter CAMF-C5-FC

→ page 20



To reduce EMC interference, use of the EMC filter is recommended for cable lengths  $\geq 10$  m.

## Axial and parallel kits EAMM

→ Internet: eamm



- Defined kits for all electro-mechanical axes from Festo
- Each kit includes the relevant necessary coupling housing, couplings and motor flange as well as all screws
- Optionally with degree of protection IP65

PROFIBUS®, PROFINET®, DeviceNet®, CANopen®, EtherCAT®, EtherNet/IP® is a registered trademark of its respective trademark holder in certain countries.

# Servo motors EMME-AS

Type codes

EMME – AS – 60 – S – LS – AM

**Type**

EMME	Motor
------	-------

**Motor type**

AS	Servo motor
----	-------------

**Motor flange size**

40	40 mm
60	60 mm
80	80 mm
100	100 mm

**Length**

S	Short
M	Medium

**Output shaft**

–	Smooth shaft
K	Shaft to DIN 6885 (with feather key)

**Winding**

LS	Low-voltage, standard
LV	Low-voltage, speed-optimised
HS	High-voltage, standard

**Electrical connection**

A	Angled plug, fixed – outlet direction: shaft
---	--

**Measuring unit**

S	Absolute encoder, single-turn
M	Absolute encoder, multi-turn
MX	Absolute safety encoder, multi-turn

**Brake**

–	None
B	With brake

# Servo motors EMME-AS

Technical data

FESTO



- Note

Motors and motor controllers from Festo are specially matched to each other. Fault-free operation cannot be guaranteed in combination with third-party controllers.



Technical data			
Flange size		40	
Length		S	M
Winding		LV	LV
<b>Motor</b>			
Nominal voltage	[V DC]	360	360
Nominal current	[A]	0.7	1.2
Continuous current at standstill	[A]	0.8	1.6
Peak current	[A]	3.2	6.4
Rated output	[W]	110	200
Nominal torque	[Nm]	0.12	0.21
Peak torque	[Nm]	0.7	1.4
Torque at standstill	[Nm]	0.18	0.35
Nominal speed	[rpm]	9000	9000
Max. speed	[rpm]	10000	10000
Motor constant	[Nm/A]	0.171	0.175
Voltage constant (phase-to-phase)	[mV/min]	13.5	13.2
Winding resistance	[Ω]	25.6	8.6
Winding inductance	[mH]	14.8	6.6
<b>Total moment of inertia of drive output</b>			
Without brake	[kgcm <sup>2</sup> ]	0.03	0.054
With brake	[kgcm <sup>2</sup> ]	0.055	0.079
<b>Shaft load at nominal speed</b>			
Radial	[N]	105	115
Axial	[N]	21	23
<b>Brake</b>			
Operating voltage	[V DC]	24 +6 ... -10%	
Performance	[W]	8	
Holding torque	[Nm]	0.4	
Mass moment of inertia	[kgcm <sup>2</sup> ]	0.014	

# Servo motors EMME-AS

Technical data

Technical data			
Flange size		60	
Length		S	M
Winding		LS	LS
<b>Motor</b>			
Nominal voltage	[V DC]	360	360
Nominal current	[A]	0.8	1.5
Continuous current at standstill	[A]	0.9	1.8
Peak current	[A]	3.6	7.2
Rated output	[W]	190	380
Nominal torque	[Nm]	0.6	1.2
Peak torque	[Nm]	2.8	6.0
Torque at standstill	[Nm]	0.7	1.5
Nominal speed	[rpm]	3000	3000
Max. speed	[rpm]	5131	4925
Motor constant	[Nm/A]	0.750	0.800
Voltage constant (phase-to-phase)	[mVmin]	49.6	51.7
Winding resistance	[Ω]	26.4	9.8
Winding inductance	[mH]	37.6	18.6
Total moment of inertia of drive output			
Without brake	[kgcm <sup>2</sup> ]	0.22	0.413
With brake	[kgcm <sup>2</sup> ]	0.319	0.512
Shaft load at nominal speed			
Radial	[N]	250	270
Axial	[N]	50	54
<b>Brake</b>			
Operating voltage	[V DC]	24 +6 ... -10%	
Performance	[W]	11	
Holding torque	[Nm]	2	
Mass moment of inertia	[kgcm <sup>2</sup> ]	0.086	

# Servo motors EMME-AS



Technical data

Technical data					
Flange size		80			
Length		S		M	
Winding		LS	HS	LS	HS
<b>Motor</b>					
Nominal voltage	[V DC]	360	565	360	565
Nominal current	[A]	2.6	1.6	3.7	2.1
Continuous current at standstill	[A]	3.1	1.8	3.9	2.2
Peak current	[A]	12.4	7.2	15.6	8.8
Rated output	[W]	750	720	1000	1000
Nominal torque	[Nm]	2.4	2.3	3.2	3.2
Peak torque	[Nm]	11.2	11.2	14.0	14.0
Torque at standstill	[Nm]	2.8	2.8	3.5	3.5
Nominal speed	[rpm]	3000	3000	3000	3000
Max. speed	[rpm]	4690	4192	4627	4097
Motor constant	[Nm/A]	0.923	1.438	0.865	1.524
Voltage constant (phase-to-phase)	[mV/min]	54.3	95.3	55	97.5
Winding resistance	[Ω]	4.6	14.2	2.8	9.0
Winding inductance	[mH]	11.8	36.2	8.4	26.0
Total moment of inertia of drive output					
Without brake	[kgcm <sup>2</sup> ]	1.40		1.93	
With brake	[kgcm <sup>2</sup> ]	1.68		2.20	
Shaft load at nominal speed					
Radial	[N]	350		360	
Axial	[N]	70		72	
<b>Brake</b>					
Operating voltage	[V DC]	24 +6 ... -10%		24 +6 ... -10%	
Performance	[W]	12		12	
Holding torque	[Nm]	4.5		4.5	
Mass moment of inertia	[kgcm <sup>2</sup> ]	0.222		0.222	

# Servo motors EMME-AS

Technical data

Technical data			
Flange size		100	
Length		S	M
Winding		HS	HS
<b>Motor</b>			
Nominal voltage	[V DC]	565	565
Nominal current	[A]	3.0	4.1
Continuous current at standstill	[A]	3.4	4.6
Peak current	[A]	13.6	18.4
Rated output	[W]	1500	2000
Nominal torque	[Nm]	4.8	6.4
Peak torque	[Nm]	22.4	30.0
Torque at standstill	[Nm]	5.6	7.5
Nominal speed	[rpm]	3000	3000
Max. speed	[rpm]	3910	3941
Motor constant	[Nm/A]	1.600	1.561
Voltage constant (phase-to-phase)	[mVmin]	102.2	101.4
Winding resistance	[Ω]	4.6	3.2
Winding inductance	[mH]	19.8	15.0
Total moment of inertia of drive output			
Without brake	[kgcm <sup>2</sup> ]	4.84	6.41
With brake	[kgcm <sup>2</sup> ]	5.63	7.20
Shaft load at nominal speed			
Radial	[N]	650	680
Axial	[N]	130	136
<b>Brake</b>			
Operating voltage	[V DC]	24 +6 ... -10%	
Performance	[W]	18	
Holding torque	[Nm]	9.0	
Mass moment of inertia	[kgcm <sup>2</sup> ]	0.654	

# Servo motors EMME-AS

Technical data

Safety characteristics – Encoder									
Type	EMME-AS-...-S				EMME-AS-...-M				
Flange size	40	60	80	100	40	60	80	100	
Measuring unit	Absolute, single-turn (SEK 34/37)				Absolute, multi-turn (SEL 34/37)				
Rotary position encoder									
MTTFd <sup>1)</sup>	Years	340			271				
Holding brake									
MTTF	Years	371	538	797	1037	371	538	797	1037
Switching cycles <sup>2)</sup>		5 million idle actuations							

1) Fault exclusions for the mechanical encoder connection are not possible

2) Guide value for the number of switching actuations (release/apply) during exclusive use as holding brake without friction (i.e. jamming at standstill)

Technical data – Encoder				
Type	EMME-AS-...-S		EMME-AS-...-M	
Measuring unit	Absolute, single-turn (SEK 34/37)		Absolute, multi-turn (SEL 34/37)	
Operating voltage	[V DC]	7 ... 12 (±5%)		
Interface signals/protocol – HIPERFACE®				
Measuring principle		Capacitive		
Process data channel		SIN, REFSIN, COS, REFCOS (analogue differential)		
Sinusoidal/cosinusoidal periods per revolution		16		
Parameter channel		RS485 (digital)		
Absolute position values per revolution		512 (resolution 9 bit)		
Maximum speed				
For absolute value generation		[rpm]	6000	
Mechanical		[rpm]	12000	
Revolutions			1	4096 revolutions, 12 bits
Interpolation of sine/cosine signals in the motor controller <sup>1)</sup>				
Measurement step at e.g. 12 bit per period		20" (angular seconds) $[360°/16/2^{12}=20"]$		
Angular accuracy		±20' (angular minutes)		

1) Dependent on the motor controller.

Weight [kg] – Encoder								
Flange size	40		60		80		100	
Length	S	M	S	M	S	M	S	M
Without brake	0.6	0.7	1.7	2.2	3.4	4.1	6.3	7.3
With brake	0.7	0.8	2.0	2.6	4.1	4.8	7.3	8.3

HIPERFACE® is a registered trademark of its respective trademark holder in certain countries.



# Servo motors EMME-AS

Technical data

Safety characteristics – Encoder with SIL transmitter <sup>1)</sup>	
Type	EMME-AS-...-MX
Measuring unit	Absolute, multi-turn (SKM36S)
Rotary position encoder	
MTTFd	874 years
Performance Level (PL) to EN ISO 13849-1	Category 3, Performance Level d
Safety integrity level (SIL) to EN 62061, EN 61508	SIL2
PFHd	$1.3 \times 10^{-8}$
T <sub>M</sub> (duration of use)	20 years
CE marking (see declaration of conformity)	To EU EMC Directive <sup>2)</sup>

- 1) Relevant documents from SICK AG → [www.sick.com](http://www.sick.com):  
 Description of HIPERFACE® Interface  
 Implementation Manuel HIPERFACE® Safety  
 Operating instructions for SKM36S Stand-Alone
- 2) For information about the applicability of the component see the manufacturer's EC declaration of conformity at: [www.festo.com/sp](http://www.festo.com/sp) → Certificates.  
 If the component is subject to restrictions on usage in residential, office or commercial environments or small businesses, further measures to reduce the emitted interference may be necessary.

Technical data – Encoder with SIL transmitter	
Type	EMME-AS-...-MX
Measuring unit	Absolute, multi-turn (SKM36S)
Operating voltage [V DC]	7 ... 12 (±5%)
Interface signals/protocol – HIPERFACE®	
Measuring principle	Optical
Process data channel	SIN, REFSIN, COS, REFCOS (analogue differential)
Sinusoidal/cosinusoidal periods per revolution	128
Parameter channel	RS485 (digital)
Absolute position values per revolution	4096 (resolution 12 bit)
Maximum speed	
For absolute value generation [rpm]	9000
Mechanical [rpm]	9000
Revolutions	4096 revolutions, 12 bits
Interpolation of sine/cosine signals in the motor controller <sup>1)</sup>	
Measurement step at e.g. 12 bit per period	2.5" (angular seconds) [ $360^\circ/128/2^{12}=2.5''$ ]
Angular accuracy	±20' (angular minutes)

- 1) Dependent on the motor controller.

Weight [kg] – Encoder with SIL transmitter						
Flange size	60		80		100	
Length	S	M	S	M	S	M
Without brake	1.7	2.2	3.4	4.1	6.3	7.3
With brake	2.0	2.6	4.1	4.8	7.3	8.3

HIPERFACE® is a registered trademark of its respective trademark holder in certain countries.

# Servo motors EMME-AS

Technical data

FESTO

Operating and environmental conditions	
Standard	IEC60034
Protection class	
Motor shaft	IP21
Motor housing incl. connection technology	IP65
Ambient temperature [°C]	-10 ... +40 (up to 100 °C with derating of 1.5% per degree Celsius)
Storage temperature [°C]	-20 ... +70
Insulation protection class	F (155 °C)
Temperature monitoring	Not integrated, only via I <sup>2</sup> t temperature monitoring model of the motor controller
Rating class to EN 60034-1	S1 (continuous operation)
Thermal class to EN 60034-1	F (155 °C)
Relative air humidity [%]	0 ... 90 (non-condensing)
CE marking (see declaration of conformity)	To EU Low Voltage Directive To EU EMC Directive <sup>1)</sup>
Approval certificate	c UL us Recognized (OL) RCM mark
Note on materials	RoHS compliant Contains paint-wetting impairment substances

- 1) For information about the applicability of the component see the manufacturer's EC declaration of conformity at: [www.festo.com/sp](http://www.festo.com/sp) → Certificates.  
If the component is subject to restrictions on usage in residential, office or commercial environments or small businesses, further measures to reduce the emitted interference may be necessary.

## Pin allocation – Motor side

Motor (M16, pins)

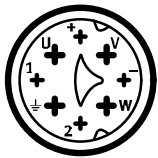

PIN	Function
U	Phase U
V	Phase V
W	Phase W
PE	PE Protective earth
+	Brake BR+
-	Brake BR-
1	n.c.
2	n.c.

Encoder (M12, pins)

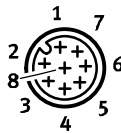

PIN	Function
1	0 V
2	Us (7 ... 12 V DC)
3	Data+ (RS485)
4	Data- (RS485)
5	SIN+
6	SIN- (REFSIN)
7	COS+
8	COS- (REFCOS)

# Servo motors EMME-AS

Technical data

## Torque M as a function of speed n

Flange size 40

Length S  
Winding LV

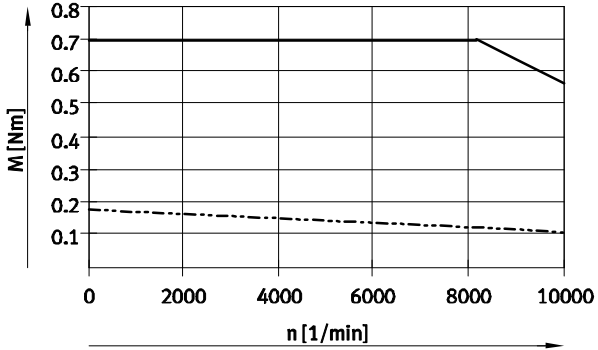

Length M  
Winding LV

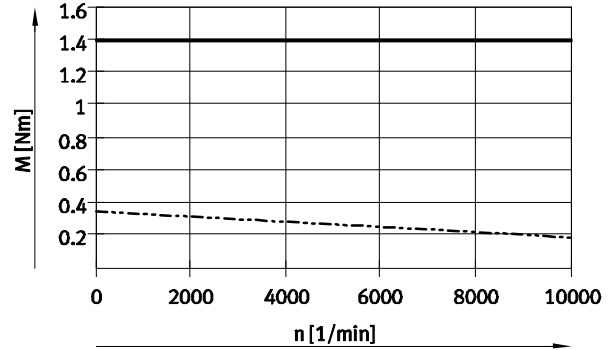

Flange size 60

Length S  
Winding LS

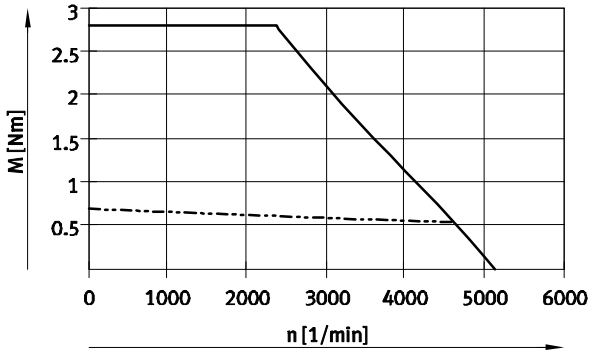

Length M  
Winding LS

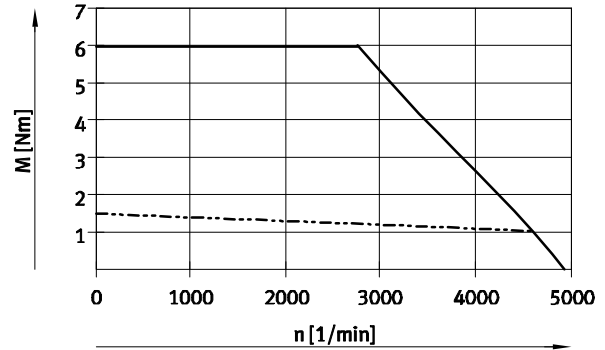

- Peak torque
- - - - - Nominal torque

 Note  
Typical motor characteristic curve with nominal voltage and optimal controller.

# Servo motors EMME-AS

Technical data

## Torque M as a function of speed n

Flange size 80

Length S

Winding LS

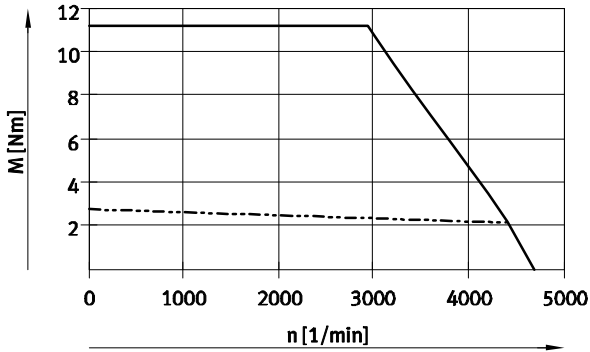

Length S

Winding HS

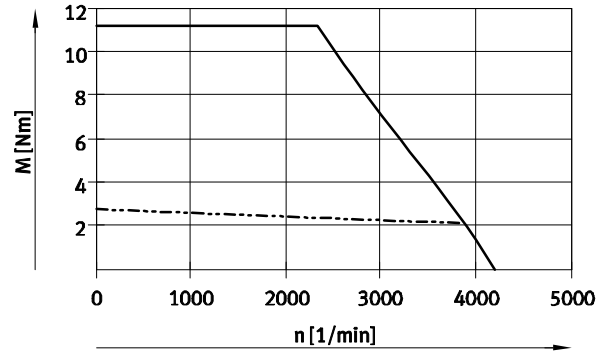

Flange size 80

Length M

Winding LS

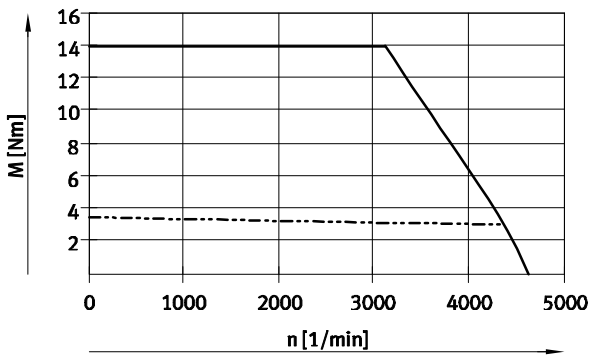

Length M

Winding HS

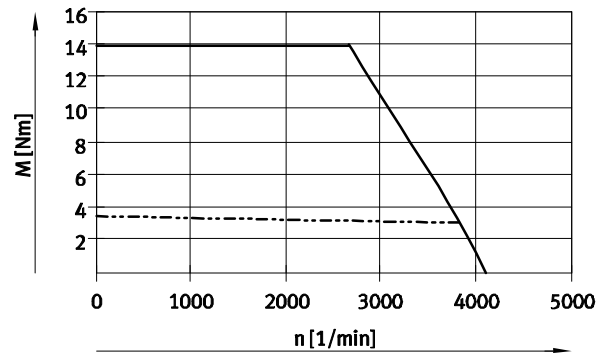

- Peak torque
- - - Nominal torque

Note

Typical motor characteristic curve with nominal voltage and optimal controller.

# Servo motors EMME-AS

Technical data

## Torque M as a function of speed n

Flange size 100

Length S

Winding HS

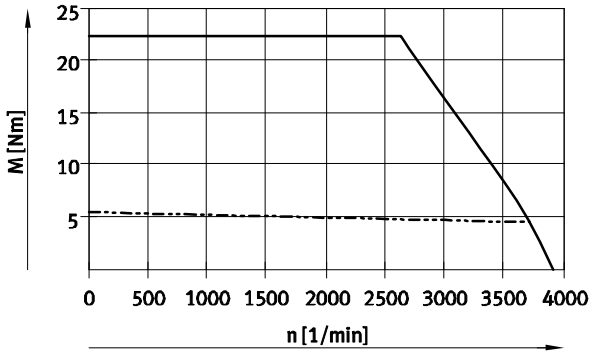

Length M

Winding HS

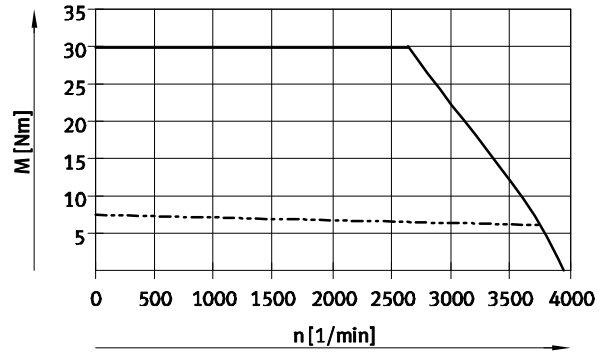

- Peak torque
- - - Nominal torque

Note

Typical motor characteristic curve with nominal voltage and optimal controller.

# Servo motors EMME-AS

Technical data

FESTO

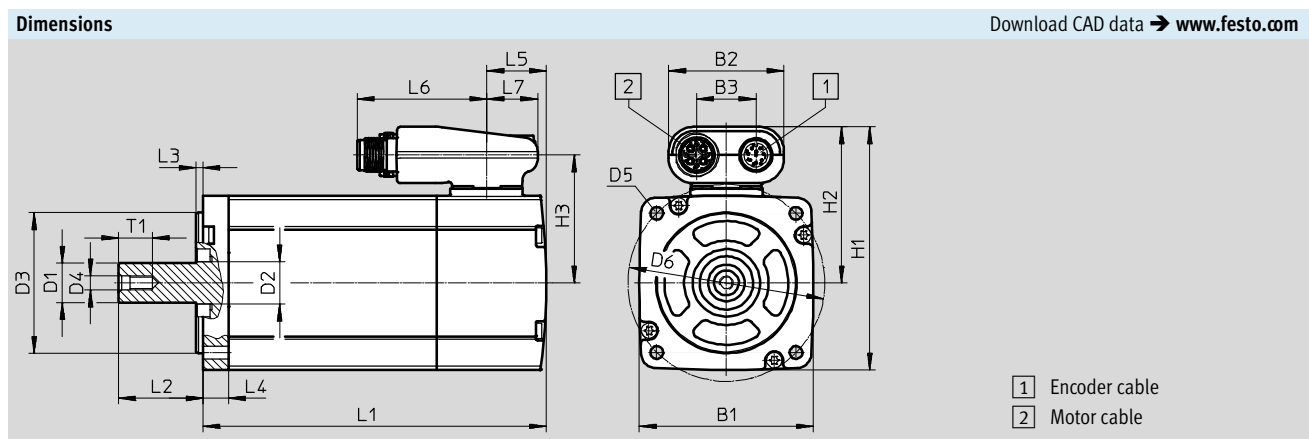

Flange size	Overall length	B1	B2	B3	D1 ∅ h6	D2 ∅	D3 ∅ h7	D4
40	S	40	41	21	8	10	30	M3
	M							
60	S	62	41	21	14	15	50	M5
	M							
80	S	82	41	21	19	20	70	M6
	M							
100	S	102	41	21	19	25	95	M6
	M							

Flange size	Overall length	D5 ∅	D6 ∅ ±0.3	H1	H2	H3	L1	
							±2	With brake ±2
40	S	3.4	45	68.5	48.5	38.5	89	124
	M							149
60	S	4.5	70	86.5	55.5	45.5	122	156
	M							186
80	S	5.5	90	106.5	65.5	55.5	158	200
	M							220
100	S	9	115	126.5	75.5	65.5	200	242
	M							267

Flange size	Overall length	L2	L3 ±0.2	L4 ±0.3	L5	L6	L7	T1
40	S	20+0.5/-0.7	2.5	4.5	25.3	46.2	18	9
	M							
60	S	30+0.5/-0.2	2.5	9	21	46.2	18	12.5
	M							
80	S	35+0.4/-0.2	3	10	23	46.2	18	16
	M							
100	S	40+0.4/-0.2	3	12	25.5	46.2	18	16
	M							

# Servo motors EMME-AS

Technical data

FESTO

## ★ Core product range

Ordering data											Part No.	Type
Overall length		Winding			Measuring unit			With feather key	Brake			
Short	Medium	Low-voltage, Standard	Low-voltage, Speed-optimised	High-voltage, Standard	Encoder, Single-turn	Encoder, Multi-turn	Encoder, Multi-turn with SIL transmitter					
Flange size 40												
■			■		■						★ 2082428	EMME-AS-40-S-LV-AS
■			■		■				■		★ 2082430	EMME-AS-40-S-LV-ASB
■			■			■					★ 2082429	EMME-AS-40-S-LV-AM
■			■			■			■		★ 2082431	EMME-AS-40-S-LV-AMB
	■		■		■						★ 2082444	EMME-AS-40-M-LV-AS
	■		■		■				■		★ 2082446	EMME-AS-40-M-LV-ASB
	■		■			■					★ 2082445	EMME-AS-40-M-LV-AM
	■		■			■			■		★ 2082447	EMME-AS-40-M-LV-AMB
Flange size 60												
■			■		■						★ 2089698	EMME-AS-60-S-LS-AS
■			■		■				■		★ 2089700	EMME-AS-60-S-LS-ASB
■			■			■					★ 2089699	EMME-AS-60-S-LS-AM
■			■			■			■		★ 2089701	EMME-AS-60-S-LS-AMB
	■		■		■						★ 2089730	EMME-AS-60-M-LS-AS
	■		■		■				■		★ 2089732	EMME-AS-60-M-LS-ASB
	■		■			■					★ 2089731	EMME-AS-60-M-LS-AM
	■		■			■			■		★ 2089733	EMME-AS-60-M-LS-AMB
Flange size 80												
■			■		■						★ 2093104	EMME-AS-80-S-LS-AS
■			■		■				■		★ 2093106	EMME-AS-80-S-LS-ASB
■			■			■					★ 2093105	EMME-AS-80-S-LS-AM
■			■			■			■		★ 2093107	EMME-AS-80-S-LS-AMB
■				■	■						★ 2093136	EMME-AS-80-S-HS-AS
■				■	■				■		★ 2093138	EMME-AS-80-S-HS-ASB
■				■		■					★ 2093137	EMME-AS-80-S-HS-AM
■				■		■			■		★ 2093139	EMME-AS-80-S-HS-AMB
	■				■						★ 2093168	EMME-AS-80-M-LS-AS
	■				■				■		★ 2093170	EMME-AS-80-M-LS-ASB
	■					■					★ 2093169	EMME-AS-80-M-LS-AM
	■					■			■		★ 2093171	EMME-AS-80-M-LS-AMB
	■			■	■						★ 2093200	EMME-AS-80-M-HS-AS
	■			■	■				■		★ 2093202	EMME-AS-80-M-HS-ASB
	■			■		■					★ 2093201	EMME-AS-80-M-HS-AM
	■			■		■			■		★ 2093203	EMME-AS-80-M-HS-AMB
Flange size 100												
■				■	■						★ 2103467	EMME-AS-100-S-HS-AS
■				■	■				■		★ 2103469	EMME-AS-100-S-HS-ASB
■				■		■					★ 2103468	EMME-AS-100-S-HS-AM
■				■		■			■		★ 2103470	EMME-AS-100-S-HS-AMB
	■			■	■						★ 2103499	EMME-AS-100-M-HS-AS
	■			■	■				■		★ 2103501	EMME-AS-100-M-HS-ASB
	■			■		■					★ 2103500	EMME-AS-100-M-HS-AM
	■			■		■			■		★ 2103502	EMME-AS-100-M-HS-AMB

Festo core product range

- ★ Ready for dispatch from the Festo factory in 24 hours
- ★ Ready for dispatch in 5 days maximum from stock

# Servo motors EMME-AS

FESTO

Technical data

Ordering data											
Overall length		Winding			Measuring unit			With feather key	Brake	Part No.	Type
Short	Medium	Low-voltage, Standard	Low-voltage, Speed-optimised	High-voltage, Standard	Encoder, Single-turn	Encoder, Multi-turn	Encoder, Multi-turn with SIL transmitter				
Flange size 60											
■		■					■			4267572	EMME-AS-60-S-LS-AMX
■		■					■	■		4267573	EMME-AS-60-S-LS-AMXB
■		■					■	■		4267574	EMME-AS-60-SK-LS-AMX
■		■					■	■	■	4267575	EMME-AS-60-SK-LS-AMXB
	■	■					■			4267576	EMME-AS-60-M-LS-AMX
	■	■					■		■	4267577	EMME-AS-60-M-LS-AMXB
	■	■					■	■		4267578	EMME-AS-60-MK-LS-AMX
	■	■					■	■	■	4267579	EMME-AS-60-MK-LS-AMXB
Flange size 80											
■		■					■			4267580	EMME-AS-80-S-LS-AMX
■		■					■		■	4267581	EMME-AS-80-S-LS-AMXB
■		■					■	■		4267582	EMME-AS-80-SK-LS-AMX
■		■					■	■	■	4267583	EMME-AS-80-SK-LS-AMXB
				■			■			4267584	EMME-AS-80-S-HS-AMX
				■			■		■	4267585	EMME-AS-80-S-HS-AMXB
				■			■	■		4267586	EMME-AS-80-SK-HS-AMX
				■			■	■	■	4267587	EMME-AS-80-SK-HS-AMXB
	■	■					■			4267588	EMME-AS-80-M-LS-AMX
	■	■					■		■	4267589	EMME-AS-80-M-LS-AMXB
	■	■					■	■		4267590	EMME-AS-80-MK-LS-AMX
	■	■					■	■	■	4267591	EMME-AS-80-MK-LS-AMXB
	■			■			■			4267592	EMME-AS-80-M-HS-AMX
	■			■			■		■	4267593	EMME-AS-80-M-HS-AMXB
	■			■			■	■		4267594	EMME-AS-80-MK-HS-AMX
	■			■			■	■	■	4267595	EMME-AS-80-MK-HS-AMXB
Flange size 100											
■				■			■			4267596	EMME-AS-100-S-HS-AMX
■				■			■		■	4267597	EMME-AS-100-S-HS-AMXB
■				■			■	■		4267598	EMME-AS-100-SK-HS-AMX
■				■			■	■	■	4267599	EMME-AS-100-SK-HS-AMXB
	■			■			■			4267600	EMME-AS-100-M-HS-AMX
	■			■			■		■	4267601	EMME-AS-100-M-HS-AMXB
	■			■			■	■		4267602	EMME-AS-100-MK-HS-AMX
	■			■			■	■	■	4267603	EMME-AS-100-MK-HS-AMXB

Festo core product range

- ★ Ready for dispatch from the Festo factory in 24 hours
- ☆ Ready for dispatch in 5 days maximum from stock



# Servo motors EMME-AS

Accessories

FESTO

## Gear unit EMGA

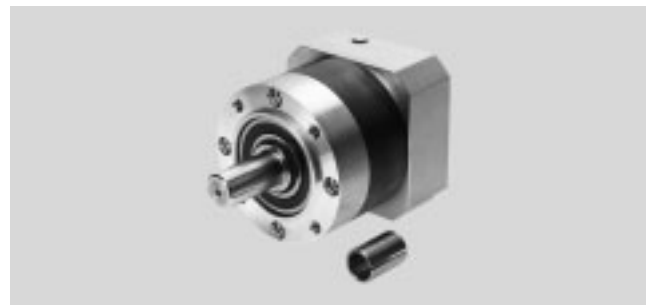

Technical data					
For motor flange size		40		60	
Gear unit type		EMGA-40-P-G...-40		EMGA-60-P-G...-60	
Gear ratio	[i]	3	5	3	5
Gear unit type		Planetary gear units			
Continuous output torque <sup>1)</sup>	[Nm]	11	14	28	40
Max. output torque <sup>2)</sup>	[Nm]	17.6	22	45	64
Max. drive speed	[rpm]	18000		13000	
Torsional rigidity	[Nm/arcmin]	1		2.3	
Torsional backlash	[deg]	0.25		0.17	
Mass moment of inertia <sup>3)</sup>	[kgcm <sup>2</sup> ]	0.031	0.019	0.135	0.078
Max. efficiency	[%]	98			
Operating temperature <sup>4)</sup>	[°C]	-25 ... +90			
Degree of protection		IP54			
Product weight	[g]	350		900	
Note on materials		RoHS-compliant			

For motor flange size		80		100		
Gear unit type		EMGA-80-P-G...-80		EMGA-80-P-G...-100		EMGA-120-P-G...-100
Gear ratio	[i]	3	5	3	5	3
Gear unit type		Planetary gear units				
Continuous output torque <sup>1)</sup>	[Nm]	85	110	85	110	115
Max. output torque <sup>2)</sup>	[Nm]	136	176	136	176	184
Max. drive speed	[rpm]	7000		7000		6500
Torsional rigidity	[Nm/arcmin]	6		6		12
Torsional backlash	[deg]	0.12		0.12		0.12
Mass moment of inertia <sup>3)</sup>	[kgcm <sup>2</sup> ]	0.77	0.45	0.77	0.45	2.63
Max. efficiency	[%]	98				
Operating temperature <sup>4)</sup>	[°C]	-25 ... +90				
Degree of protection		IP54				
Product weight	[g]	2000		2100		6000
Note on materials		RoHS-compliant				

- 1) At the output shaft
- 2) The specifications refer to an output shaft speed of 100 rpm as well as operating mode S1 and a temperature of 30°C
- 3) In relation to the drive shaft
- 4) Note the temperature range of the motor

# Servo motors EMME-AS

Accessories

FESTO

## Dimensions

Download CAD data → [www.festo.com](http://www.festo.com)

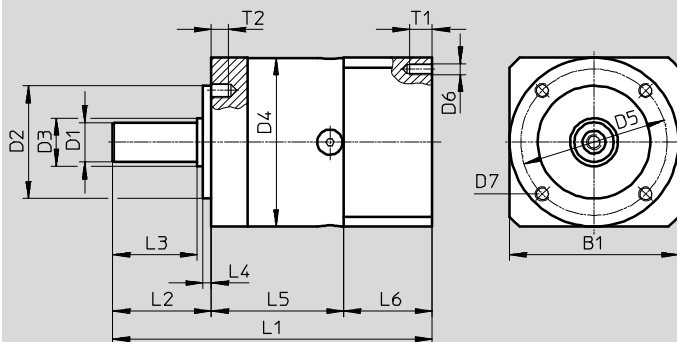

Type	B1	D1 ∅ h7	D2 ∅ h7	D3 ∅	D4 ∅	D5 ∅	D6	D7
EMGA-40-P-G...-40	40	10	26	12	40	34	M3	M4
EMGA-60-P-G...-60	60	14	40	17	60	52	M4	M5
EMGA-80-P-G...-80	80	20	60	25	80	70	M5	M6
EMGA-80-P-G...-100	100	20	60	25	80	70	M8	M6
EMGA-120-P-G...-100	115	25	80	35	115	100	M8	M10

Type	L1	L2	L3 ±0.2	L4 ±0.2	L5	L6	T1	T2
EMGA-40-P-G...-40	93.5	26	23	2	39	28.5	8	6
EMGA-60-P-G...-60	113.5	35	30	3	47	31	10	8
EMGA-80-P-G...-80	138.5	40	36	3	60	38.5	12	10
EMGA-80-P-G...-100	143.5	40	36	3	60	43.5	16	10
EMGA-120-P-G...-100	176.5	55	50	4	74	47.5	20	16

## Ordering data

For motor flange size	Gear ratio	Part No.	Type
40	3	★ 2297684	EMGA-40-P-G3-EAS-40
	5	★ 2297685	EMGA-40-P-G5-EAS-40
60	3	★ 2297686	EMGA-60-P-G3-EAS-60
	5	★ 2297687	EMGA-60-P-G5-EAS-60
80	3	★ 2297690	EMGA-80-P-G3-EAS-80
	5	★ 2297691	EMGA-80-P-G5-EAS-80
100	3	★ 552194	EMGA-80-P-G3-SAS-100
	5	★ 552195	EMGA-80-P-G5-SAS-100
	3	★ 552196	EMGA-120-P-G3-SAS-100
	5	★ 552197	EMGA-120-P-G5-SAS-100

# Servo motors EMME-AS

Accessories

FESTO

Technical data – Cables		
Description	Motor cable	
For motor	EMME-AS-40/60	EMME-AS-80/100
Type	NEBM-M16G8-...-Q7-...	NEBM-M16G8-...-Q9-...
Cable composition	2x (2x 0.25 mm <sup>2</sup> ) (3 A, 48 V, 0.5 KV)	2x (2x 0.5 mm <sup>2</sup> ) (8 A, 300 V, 2.5 KV)
	4x 0.75 mm <sup>2</sup> (12 A, 600 V, 2.5 KV)	4 x 1.5 mm <sup>2</sup> (16 A, 600 V, 2.5 KV)
	Screened	
Degree of contamination	3	
Min. bending radius [mm]	55	64
Ambient temperature [°C]	-50 ... +90	-50 ... +90
Ambient temperature <sup>1)</sup> [°C]	-40 ... +90	-40 ... +90
Cable characteristic	Suitable for use with energy chains	
Degree of protection	IP65 (in assembled state)	
Material	Polyurethane	
Note on materials	RoHS compliant	
CE marking (see declaration of conformity)	To EU Low Voltage Directive	

Description	Encoder cable	
For motor	EMME-AS-40/60/80/100	
Type	NEBM-M12G8-...	
Cable composition	4x (2x 0.14 mm <sup>2</sup> )	
	Screened	
Degree of contamination	3	
Min. bending radius [mm]	68	
Ambient temperature [°C]	-40 ... +80	
Ambient temperature <sup>1)</sup> [°C]	-5 ... +80	
Cable characteristic	Suitable for use with energy chains	
Degree of protection	IP65 (in assembled state)	
Material	Polyurethane	
Note on materials	RoHS compliant	

1) With flexible cable installation

## Recommended cable cross section as a function of cable length $l$ and max. motor current $I_0$

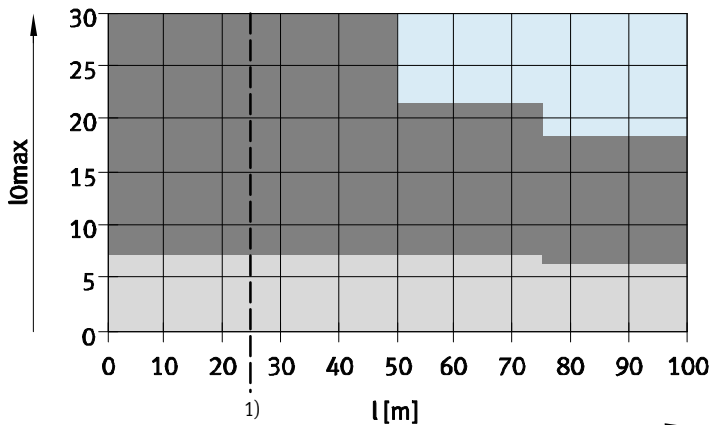



1) Cable lengths > 25 m possible following technical clarification; up to 100 m on request.

No standard  
 1.5 mm<sup>2</sup>  
 0.75 mm<sup>2</sup>

# Servo motors EMME-AS

Accessories

FESTO

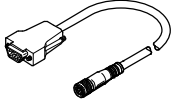
Ordering data			
	Cable length [m]	Part No.	Type
<b>Motor cable</b>			
	For EMME-AS-40/60 (cable cross section: 0.75 mm <sup>2</sup> )		
	2.5	★ 8004662	NEBM-M16G8-E-2.5-Q7-LE8
	5	★ 8003770	NEBM-M16G8-E-5-Q7-LE8
	7.5	★ 8004663	NEBM-M16G8-E-7.5-Q7-LE8
	10	★ 8003771	NEBM-M16G8-E-10-Q7-LE8
	15	★ 8003772	NEBM-M16G8-E-15-Q7-LE8
	X length <sup>1)</sup>	8003773	NEBM-M16G8-E--Q7-LE8
	For EMME-AS-80/100 (cable cross section: 1.5 mm <sup>2</sup> )		
	2.5	★ 8004660	NEBM-M16G8-E-2.5-Q9-LE8
	5	★ 8003766	NEBM-M16G8-E-5-Q9-LE8
	7.5	★ 8004661	NEBM-M16G8-E-7.5-Q9-LE8
	10	★ 8003767	NEBM-M16G8-E-10-Q9-LE8
	15	★ 8003768	NEBM-M16G8-E-15-Q9-LE8
	X length <sup>1)</sup>	8003769	NEBM-M16G8-E--Q9-LE8
<b>Encoder cable</b>			
	For EMME-AS-40/60/80/100		
	2.5	★ 8004664	NEBM-M12G8-E-2.5-N-S1G15
	5	★ 8003762	NEBM-M12G8-E-5-N-S1G15
	7.5	★ 8004665	NEBM-M12G8-E-7.5-N-S1G15
	10	★ 8003763	NEBM-M12G8-E-10-N-S1G15
	15	★ 8003764	NEBM-M12G8-E-15-N-S1G15
	X length <sup>1)</sup>	8003765	NEBM-M12G8-E--N-S1G15

1) Max. 25 m. Cable lengths > 25 m possible following technical clarification; up to 100 m on request. Available in 0.1 m increments.

## Ordering data – EMC filter

To reduce EMC interference, use of the EMC filter is recommended for cable lengths  $\geq$  10 m.

The filter is included in the scope of delivery for encoder cables  $\geq$  10 m.

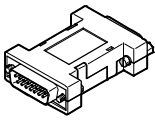
	Degree of protection	Ambient temperature	Part No.	Type
	IP30 (in mounted state)	-40 ... +80 °C	4825847	CAMF-C5-FC

Festo core product range

- ★ Ready for dispatch from the Festo factory in 24 hours
- ☆ Ready for dispatch in 5 days maximum from stock