

Electric cylinders EPCO, with spindle drive



Festo core product range
Covers 80% of your automation tasks

Worldwide:

Always in stock

Superb:

Festo quality at an attractive price

Easy:

Reduces procurement and storing complexity



Ready for dispatch from the Festo factory in 24 hours
Held in stock in 13 service centres worldwide
More than 2200 products



Ready for dispatch in 5 days maximum from stock
Assembled for you in 4 service centres worldwide
Up to 6×10^{12} variants per product series

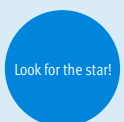

Electric cylinders EPCO, with spindle drive

Key features

At a glance		
General	Properties	Range of applications
<p>The electric cylinder EPCO is a mechanical linear drive with piston rod and permanently attached motor. The driving component consists of an</p>	<p>electrically actuated spindle that converts the rotary motion of the motor into a linear motion of the piston rod.</p> <ul style="list-style-type: none"> • With recirculating ball spindle • Optionally with female thread • Optionally with holding brake • Degree of protection IP40 • Compact dimensions • Extensive mounting accessories for various installation situations 	<ul style="list-style-type: none"> • Suitable for simple applications in factory automation that in the past were mostly carried out using pneumatic solutions

Optimised Motion Series (OMS)

A package that makes positioning easier than ever before. The Optimised Motion Series is as easy to handle as a pneumatic cylinder, but with the functionality of an electric drive.



Simple to select	Ordering and logistics	Quick to configure
<ul style="list-style-type: none"> • Easy sizing and selection using cycle time charts • No specialist knowledge of electric drive technology required 	<ul style="list-style-type: none"> • All the part components required with a single part number • Motors mounted on electric cylinders 	<ul style="list-style-type: none"> • Parameterisation and commissioning via web server/browser • Parameterise up to 7 freely definable positions directly on the PC



For simple positioning tasks

Electric cylinder EPCO



Controller CMMO
→ page 38



Electric cylinders EPCO, with spindle drive

Key features

Motor mounting variants

EPCO-16

Standard

Underneath (feature D)

Left (feature L)

Right (feature R)

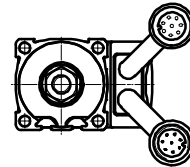
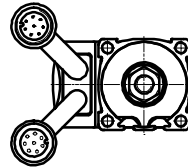
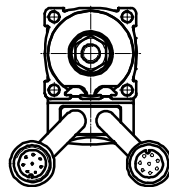
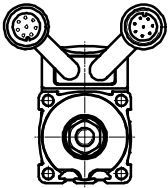

EPCO-25/-40

Standard

Underneath (feature D)

Left (feature L)

Right (feature R)

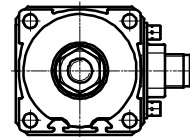
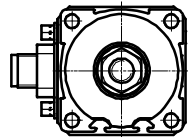
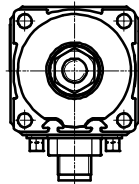
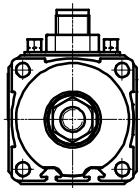

Electric cylinder EPCO with guide unit EAGF-P1



The guide unit protects ISO standard cylinders from torsion when these are subjected to high torque loads. It offers high precision guiding for workpiece handling and other applications.

The guide unit can optionally be ordered via the modular product system.

Integrated mounting interfaces allow direct mounting for numerous multi-axis combinations, including connection to:

- Toothed belt axis ELGR
- Rotary drive ERMO
- Mini slide DGSL

Technical data

→ page 15

Ordering data

EPCO with guide unit EAGF assembled

→ page 26

Guide unit EAGF as an accessory

→ page 35

Electric cylinders EPCO, with spindle drive

Key features



Possible combinations within the Optimised Motion Series (OMS)

Electric cylinder EPCO on toothed belt axis ELGR

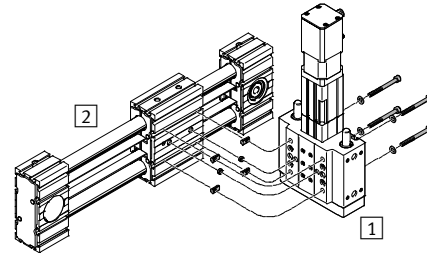
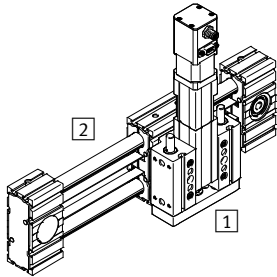

Size		Accessories			
1	2	Slot nut	Centring sleeve	Screw	Washer
16	35	NST-3-M3 (x4)	ZBH-7 (x2)	M3x10 (x4)	–
25	45	NST-5-M5 (x4)	ZBH-7 (x2)	M5x50 (x4)	DIN125-A5.3 (x4)
40	55	NST-5-M5 (x4)	ZBH-7 (x2)	M5x65 (x4)	DIN125-A5.3 (x4)

Rotary drive ERMO on electric cylinder EPCO

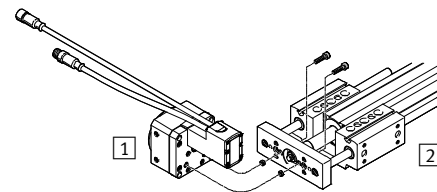
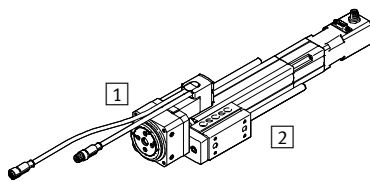

Size		Accessories	
1	2	Centring sleeve	Screw
12	16	ZBH-7 (x2)	M4x16 (x2)
16	25	ZBH-7 (x2)	M5x18 (x2)
25	40	ZBH-7 (x2)	M5x20 (x2)

Rotary drive ERMO on mini slide DGSL

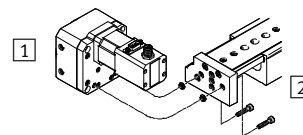
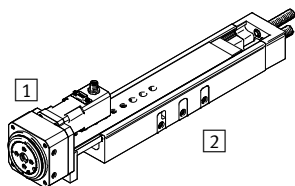

Size		Accessories	
1	2	Centring sleeve	Screw
12	12	ZBH-7 (x2)	M4x18 (x2)
25	20	ZBH-9-7 (x2)	M5x22 (x2)
25	25	ZBH-9-7 (x2)	M5x22 (x2)

Rotary drive ERMO on mini slide EGSL

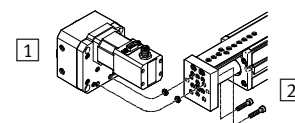
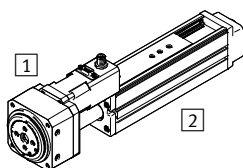

Size		Accessories	
1	2	Centring sleeve	Screw
12	35	ZBH-7 (x2)	M4x12 (x2)
16	45	ZBH-7 (x2)	M5x12 (x2)
25	55	ZBH-7 (x2)	M5x14 (x2)
32	55	ZBH-7 (x2)	M5x14 (x2)

Electric cylinders EPCO, with spindle drive

Key features

Possible combinations within the Optimised Motion Series (OMS)

Electric cylinder EPCO on electric cylinder EPCO, horizontal

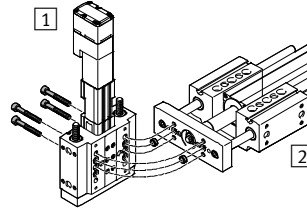
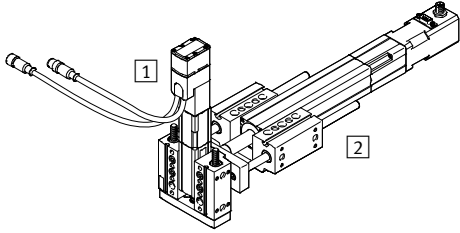

Size		Accessories	
1 EPCO	2 EPCO	Centring sleeve	Screw
16	25	ZBH-9 (x2)	M6x40 (x4)
25	40	ZBH-9 (x2)	M6x55 (x4)

Electric cylinder EPCO on electric cylinder EPCO, vertical

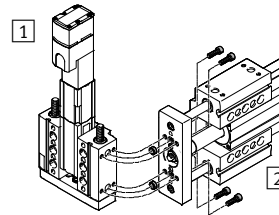
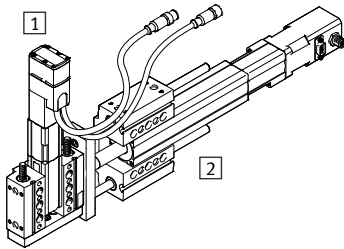

Size		Accessories	
1 EPCO	2 EPCO	Centring sleeve	Screw
16	25	ZBH-9 (x2)	M5x18 (x4)
25	40	ZBH-9 (x2)	M5x22 (x4)

Mini slide DGSL on electric cylinder EPCO

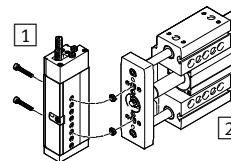
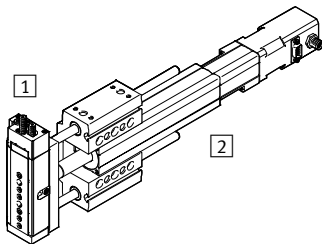

Size		Accessories	
1 DGSL	2 EPCO	Centring sleeve	Screw
8 (40mm) ¹⁾	16	ZBV-9-7 (x2)	M4x16 (x2)
10 (30mm) ¹⁾	25	ZBV-9-7 (x2)	M4x20 (x2)
12 (40mm) ¹⁾	40	ZBV-9-7 (x2)	M5x20 (x2)

1) Minimum stroke

Electric cylinders EPCO, with spindle drive

Type codes

		EPCO	-	16	-	100	-	3P	-		-		-	A	-	ST	-	E	B	
Type																				
EPCO	Electric cylinder																			
Size																				
Stroke [mm]																				
Spindle pitch																				
Piston rod thread type																				
-	Male thread																			
F	Female thread																			
Piston rod extension																				
-	None																			
...E	0 ... 200 mm																			
Position sensing																				
-	None																			
A	Via proximity sensor																			
Motor type																				
ST	Stepper motor																			
Measuring unit																				
-	None																			
E	Encoder																			
Brake																				
-	None																			
B	With brake																			

Electric cylinders EPCO, with spindle drive

Type codes

-		-		+	2.5E	+	C5	DIO	N
Cable outlet direction									
-	Top (standard)								
D	Underneath								
L	Left								
R	Right								
Guide unit									
-	None								
KF	Recirculating ball bearing guide with two guide rods								
Connecting cable to motor controller									
-	None								
1.5E	1.5 m, straight plug								
1.5EA	1.5 m, angled plug								
2.5E	2.5 m, straight plug								
2.5EA	2.5 m, angled plug								
5E	5 m, straight plug								
5EA	5 m, angled plug								
7E	7 m, straight plug								
7EA	7 m, angled plug								
10E	10 m, straight plug								
10EA	10 m, angled plug								
Controller type									
-	None								
C5	CMMO, 5 A								
Bus protocol/activation									
-	None								
DIO	Digital I/O interface								
LK	IO-Link								
Switching input/output									
-	None								
N	NPN								
P	PNP								

Electric cylinders EPCO, with spindle drive

Peripherals overview

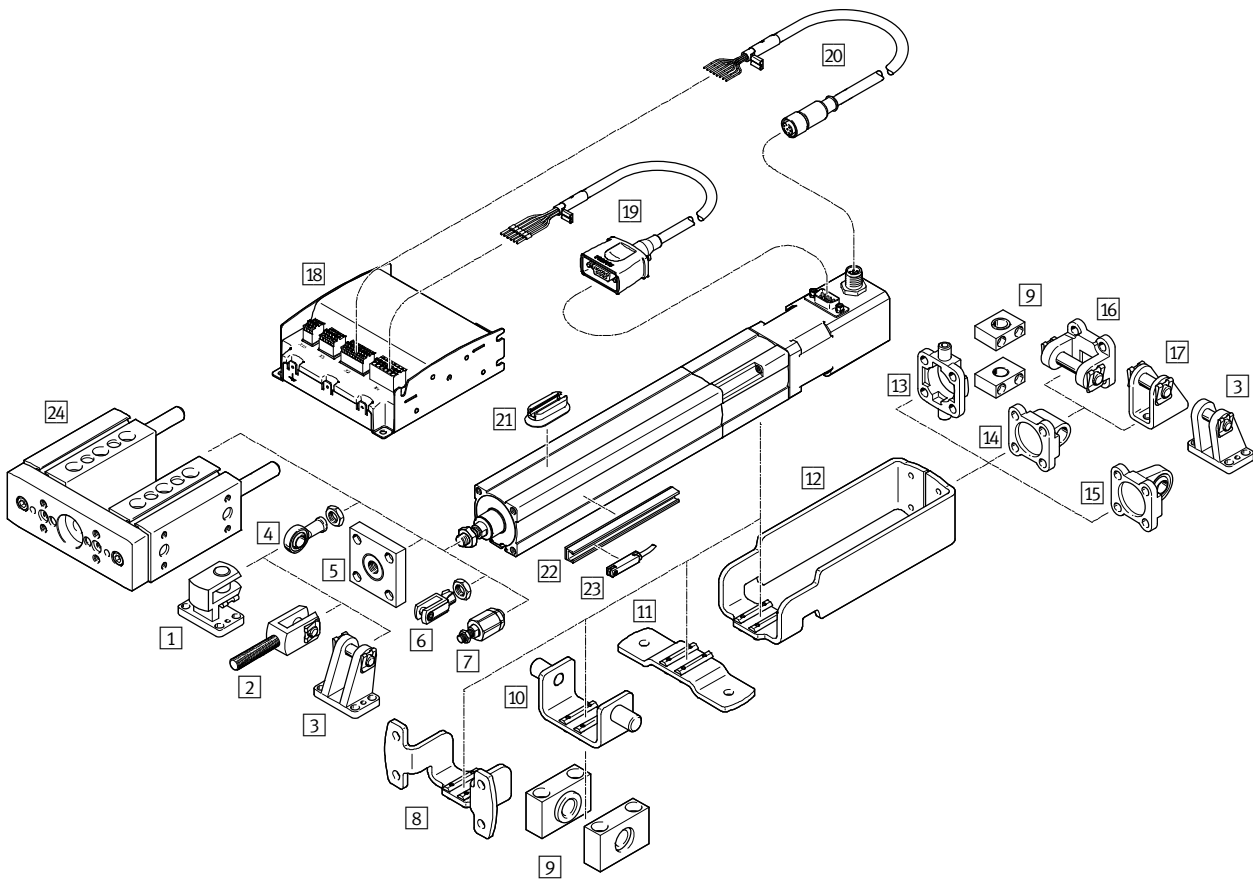

Mounting attachments and accessories					
	Description	For size			→ Page/Internet
		16	25	40	
1	Right-angle clevis foot LQG	-	-	■	34
2	Rod clevis SGA	-	-	■	35
3	Clevis foot LBG	-	-	■	34
4	Rod eye SGS/CRSGS	■	■	■	35
5	Coupling piece KSG	-	-	■	35
6	Rod clevis SG/CRSG	■	■	■	35

Electric cylinders EPCO, with spindle drive

Peripherals overview

Mounting attachments and accessories						
	Description	For size			→ Page/Internet	
		16	25	40		
7	Self-aligning rod coupler FK	For compensating radial and angular deviations	■	■	■	35
8	Flange mounting EAHH	– For mounting the electric cylinder via the profile – Position freely selectable along the cylinder length	■	■	■	29
9	Trunnion support LNZG	For mounting the cylinder in combination with swivel mounting or trunnion flange	■	■	■	32
10	Swivel mounting EAHS	Position freely selectable along the cylinder length	■	■	■	30
11	Foot mounting EAHF	Position freely selectable along the cylinder length	■	■	■	28
12	Adapter kit EAHA	For mounting swivel flange and trunnion flange on the front side. The only motor connection that can be ordered with this adapter kit is for top or bottom mounting.	■	■	■	31
13	Trunnion flange ZNCF	For spherical bearing. It cannot be mounted when turned by 90°	–	–	■	32
14	Swivel flange SNCL	For spherical bearing	■	■	■	33
15	Swivel flange SNCS	For spherical bearing	–	–	■	33
16	Swivel flange SNCB/SNCB-...-R3	For spherical bearing	–	–	■	34
17	Clevis foot LBN	For spherical bearing	■	■	■	34
18	Controller CMMO	For parameterising and positioning the electric cylinder	■	■	■	38
19	Motor cable NEBM	For connecting the motor and controller	■	■	■	38
20	Encoder cable NEBM	For connecting the encoder and controller	■	■	■	38
21	Mounting kit CRSMB	For proximity sensor SME/SMT-8	■	■	■	37
22	Sensor rail SAMH	– For proximity sensor SME/SMT-8 – Size 25 only with proximity sensor SMT-8	■	■	■	37
23	Proximity sensor SME/SMT-8	For homing or position sensing	■	■	■	36
24	Guide unit EAGF-P1	For protecting electric cylinders against rotation at high torque loads	■	■	■	35

 Note

For applications involving high loads, the cylinder must not be mounted exclusively via the mounting thread on the front.

The mass of the motor can be amplified by the lever effect, which can result in the mounting thread being torn out.



Electric cylinders EPCO, with spindle drive

FESTO

Technical data

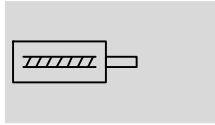
Function



-  Size
16 ... 40
-  Stroke length
50 ... 400 mm
-  www.festo.com



General technical data			
Size	16	25	40
Design	Electric cylinder with recirculating ball spindle and motor		
Piston rod thread			
Male thread	M6	M8	M10x1.25
Female thread	M4	M6	M8
Working stroke [mm]	50 ... 200	50 ... 300	50 ... 400
Stroke reserve [mm]	0		
Max. torsion angle of the piston rod [°]	≤ ±2	≤ ±1.5	≤ ±1
Impact energy at the end positions [J]	0.1x 10 ⁻³	0.2x 10 ⁻³	0.4x 10 ⁻³
Position sensing	Via proximity sensor		
Type of mounting	Via female thread Via accessories		
Mounting position	Any		

Mechanical data						
Size	16		25		40	
Spindle design	3P	8P	3P	10P	5P	12.7P
Spindle pitch ¹⁾ [mm/rev]	3	8	3	10	5	12.7
Spindle diameter [mm]	8	8	10	10	12	12.7
Max. payload						
Horizontal ²⁾ [kg]	24	8	60	20	120	40
Vertical [kg]	12	4	30	10	60	20
Max. feed force F _x [N]	125	50	350	105	650	250
Max. speed [mm/s]	125	300	150	500	180	460
Max. acceleration [m/s ²]	10					
Reversing backlash ³⁾ [mm]	≤ 0.1					
Repetition accuracy [mm]	±0.02					

1) Nominal value varies due to component tolerances.

2) Note max. lateral force.

3) In new condition.

Electrical data			
Size	16	25	40
Motor			
Nominal voltage [V DC]	24		
Nominal current [A]	1.4	3	4.2
Brake			
Nominal voltage [V DC]	24 ±10%		
Rated output [W]	8		
Holding torque [Nm]	0.09	0.5	1.13
Mass moment of inertia [kgmm ²]	1.8	8.2	29

Electric cylinders EPCO, with spindle drive

Technical data

Electrical data			
Size	16	25	40
Encoder			
Rotary position encoder	Incremental		
Rotary position encoder measuring principle	Opto-electrical		
Pulses/revolution [1/rev]	500		
Interface	RS422, TTL, AB channel, zero index		
Operating voltage of encoder [V DC]	5		

Operating and environmental conditions		
Ambient temperature ¹⁾ [°C]	0 ... +50	
Storage temperature [°C]	-20 ... +60	
Relative air humidity [%]	0 ... 85 (non-condensing)	
Degree of protection to IEC 60529	IP40	
Corrosion resistance class CRC ²⁾	1	
Duty cycle [%]	100	
CE marking (see declaration of conformity)	To EU EMC Directive ³⁾	
Certification	c UL us Recognized (OL) RCM trademark	

- Note operating range of proximity sensors.
- Corrosion resistance class CRC 1 to Festo standard FN 940070
Low corrosion stress. For dry indoor applications or transport and storage protection. Also applies to parts behind covers, in the non-visible interior area, and parts which are covered in the application (e.g. drive trunnions).
- For information about the applicability of the component see the manufacturer's EC declaration of conformity at: www.festo.com/sp → Certificates.
If the component is subject to restrictions on usage in residential, office or commercial environments or small businesses, further measures to reduce the emitted interference may be necessary.

Weight [kg]			
Size	16	25	40
Basic weight with 0 mm stroke			
EPCO-...	0.62	1.04	2.49
EPCO-...-E	0.62	1.13	2.59
EPCO-...-B	0.68	1.22	2.71
EPCO-...-EB	0.68	1.28	2.77
EPCO-...-KF	1.22 ... 1.28	2.12 ... 2.36	4.40 ... 4.68
Additional weight per 100 mm stroke			
EPCO-...	0.17	0.34	0.55
EPCO-...-KF	0.25	0.46	0.73
Moving load with 0 mm stroke			
EPCO-...	0.07	0.15	0.42
EPCO-...-KF	0.23	0.45	0.98
Moving load per 100 mm stroke			
EPCO-...	0.020	0.026	0.049
EPCO-...-KF	0.100	0.146	0.229

Mass moment of inertia							
Size	16		25		40		
Spindle design	3P	8P	3P	10P	5P	12.7P	
J ₀ with 0 mm stroke							
EPCO-...	[kg mm ²]	2.28	2.29	9.33	9.40	33.25	33.75
EPCO-...-B	[kg mm ²]	2.97	2.98	10.63	10.70	34.55	35.05
j _s per metre stroke	[kg mm ² /m]	2.53	2.65	4.87	5.78	11.66	16.70
j _L per kg payload	[kg mm ² /kg]	0.23	1.62	0.23	2.54	0.64	4.09

The mass moment of inertia J_A of the electric cylinder is calculated as follows:

$$J_A = J_0 + j_s \times \text{working stroke [m]} + j_L \times m_{\text{moving payload [kg]}}$$

Electric cylinders EPCO, with spindle drive

Technical data

Materials

Sectional view

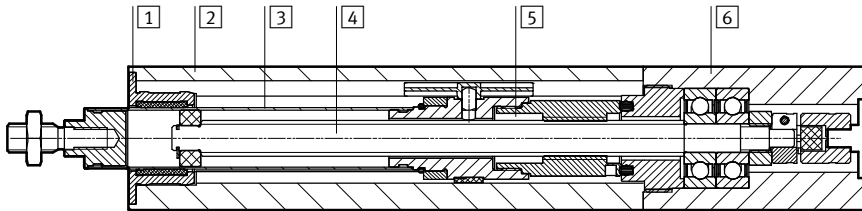

Electric cylinder		
1	Bearing cap	Wrought aluminium alloy
2	Cylinder barrel	Wrought aluminium alloy
3	Piston rod	High-alloy stainless steel
4	Spindle	Steel
5	Spindle nut	Steel
6	Drive cover	Wrought aluminium alloy
Note on materials		RoHS-compliant
		Contains PWIS (paint-wetting impairment substances)

Piston rod deflection f as a function of projection A and lateral force F

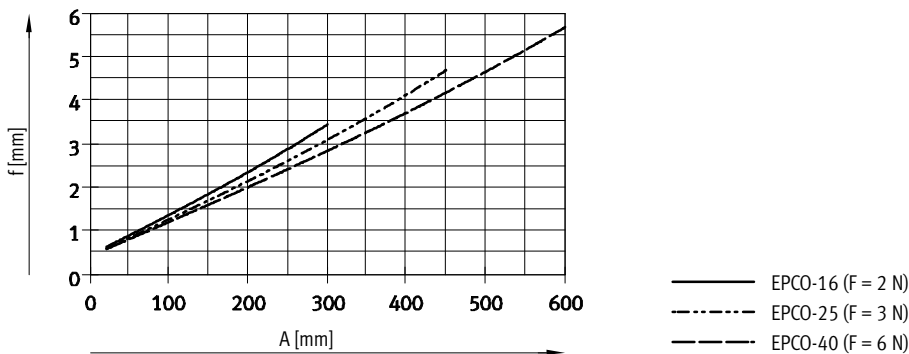
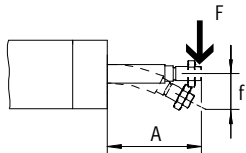

Electric cylinders EPCO, with spindle drive

Technical data

Maximum permissible loads on the piston rod

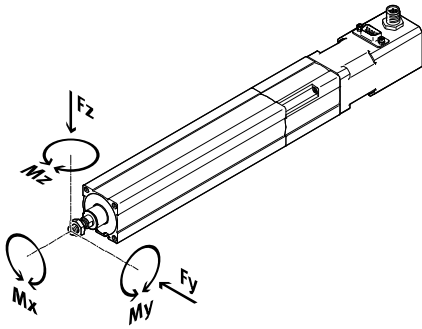

If there are two or more forces and torques simultaneously acting on the piston rod, the following equations must be satisfied:

$$\frac{|F_y|}{F_{y_{max}}} + \frac{|F_z|}{F_{z_{max}}} + \frac{|M_y|}{M_{y_{max}}} + \frac{|M_z|}{M_{z_{max}}} \leq 1$$

$$|F_x| \leq F_{x_{max}}$$

$$|M_x| \leq M_{x_{max}}$$

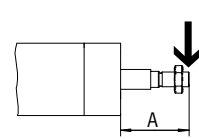

Maximum permissible lateral forces $F_{y_{max}}$ and $F_{z_{max}}$ on the piston rod as a function of projection A

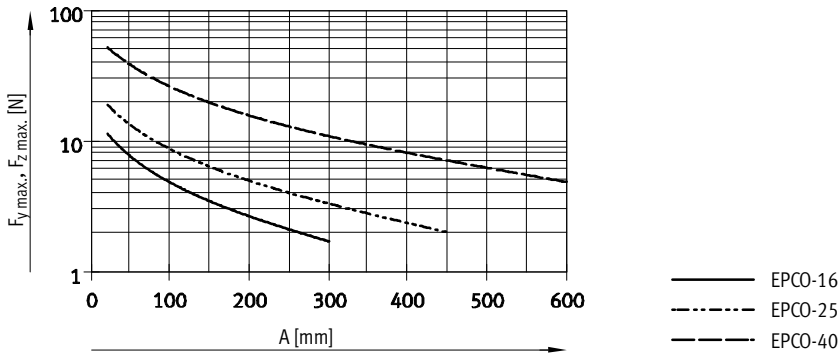

Size	16		25		40	
Spindle design	3P	8P	3P	10P	5P	12.7P
$F_{x_{max}}$ (static) [N]	125	50	350	105	650	250
$M_{x_{max}}$ [Nm]	0		0		0	
$M_{y_{max}}, M_{z_{max}}$ [Nm]	0.6		1.0		3.3	

Note
PositioningDrives
engineering software
→ www.festo.com

Electric cylinders EPCO, with spindle drive

Technical data



Payload m as a function of speed v and acceleration a

Horizontal mounting position

EPCO-16-3P

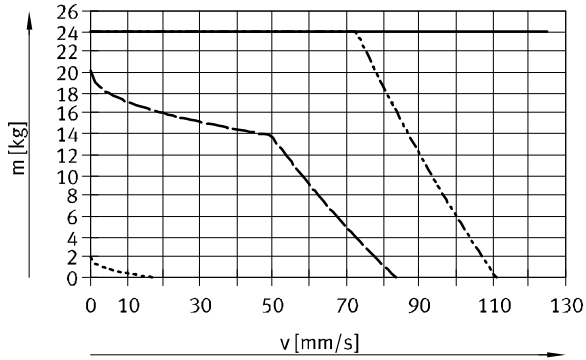

For EPCO-... / EPCO-...-KF

- $a = 0.5 \text{ m/s}^2$
- - - $a = 2.5 \text{ m/s}^2$
- · - $a = 5 \text{ m/s}^2$
- · · $a = 10 \text{ m/s}^2$

EPCO-16-8P

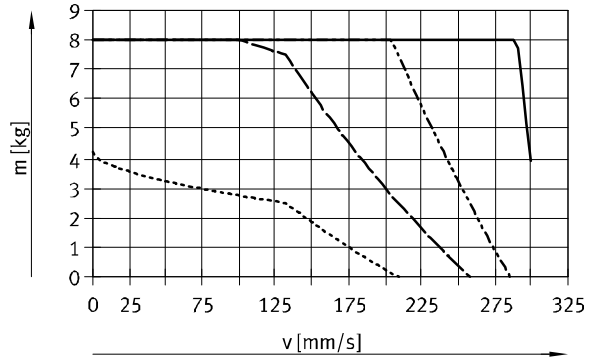

EPCO-25-3P

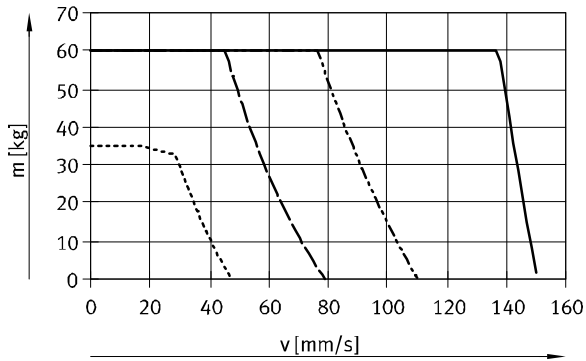

For EPCO-... / EPCO-...-KF

- $a = 0.5 \text{ m/s}^2$
- - - $a = 2.5 \text{ m/s}^2$
- · - $a = 5 \text{ m/s}^2$
- · · $a = 10 \text{ m/s}^2$

EPCO-25-10P

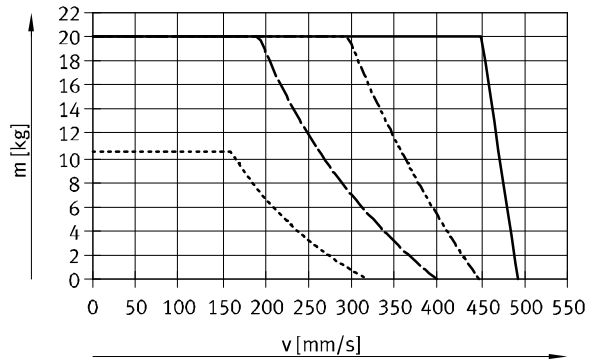

EPCO-40-5P

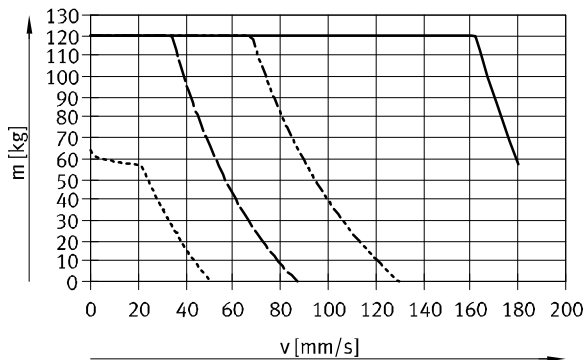

For EPCO-... / EPCO-...-KF

- $a = 0.5 \text{ m/s}^2$
- - - $a = 2.5 \text{ m/s}^2$
- · - $a = 5 \text{ m/s}^2$
- · · $a = 10 \text{ m/s}^2$

EPCO-40-12.7P

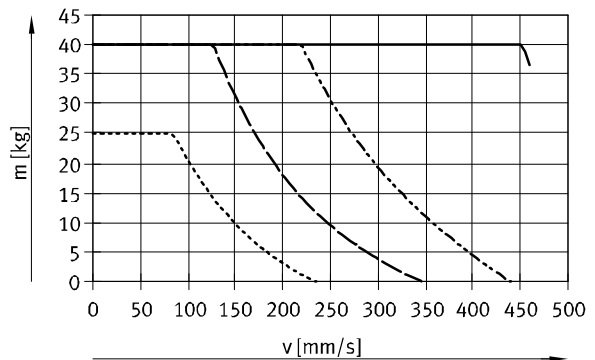

Electric cylinders EPCO, with spindle drive

Technical data

Payload m as a function of speed v and acceleration a

Vertical mounting position

The moving tare weight of the guide unit (EPCO-...-KF) results in lower acceleration values with identical payload and speed.

EPCO-16-3P

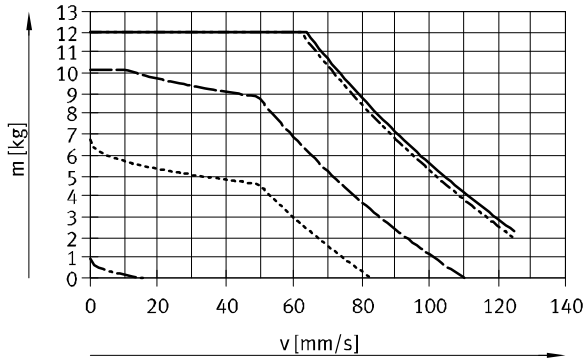

For EPCO-...	For EPCO-...-KF
— a = 0 m/s ²	a = 0 m/s ²
- - - a = 0.2 m/s ²	a = 2.3 m/s ²
- - - a = 2.5 m/s ²	a = 4.7 m/s ²
- - - a = 5 m/s ²	a = 9.6 m/s ²
- - - a = 10 m/s ²	

EPCO-16-8P

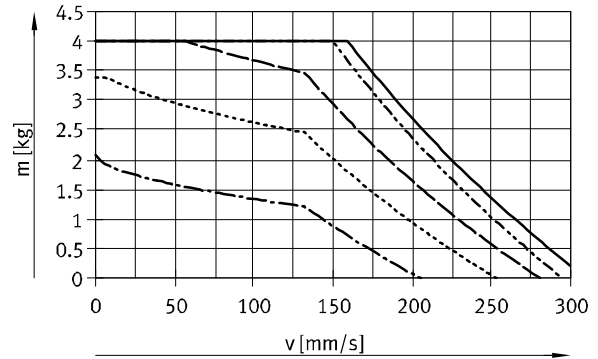

For EPCO-...	For EPCO-...-KF
— a = 0 m/s ²	a = 0 m/s ²
- - - a = 1.2 m/s ²	a = 1.2 m/s ²
- - - a = 2.5 m/s ²	a = 3.4 m/s ²
- - - a = 5 m/s ²	a = 7.8 m/s ²
- - - a = 10 m/s ²	

EPCO-25-3P

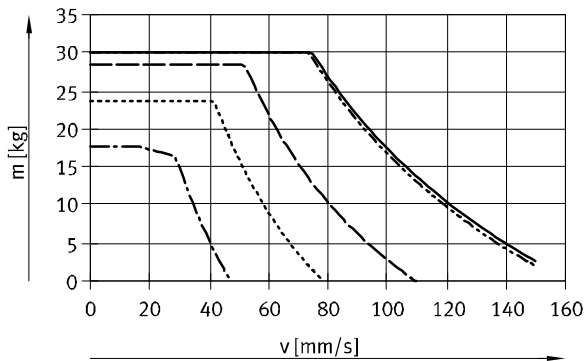

For EPCO-...	For EPCO-...-KF
— a = 0 m/s ²	a = 0 m/s ²
- - - a = 0.2 m/s ²	a = 2.4 m/s ²
- - - a = 2.5 m/s ²	a = 4.9 m/s ²
- - - a = 5 m/s ²	a = 9.8 m/s ²
- - - a = 10 m/s ²	

EPCO-25-10P

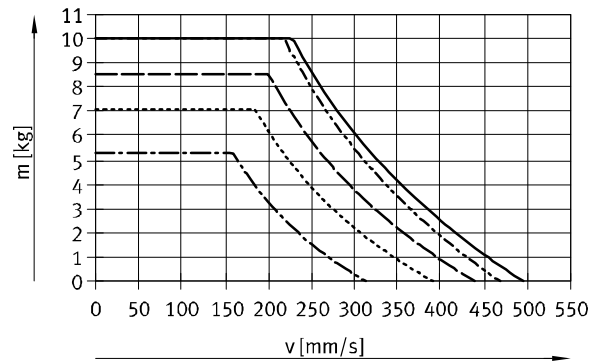

For EPCO-...	For EPCO-...-KF
— a = 0 m/s ²	a = 0 m/s ²
- - - a = 1.2 m/s ²	a = 1.6 m/s ²
- - - a = 2.5 m/s ²	a = 3.9 m/s ²
- - - a = 5 m/s ²	a = 8.3 m/s ²
- - - a = 10 m/s ²	

Further technical data for the guide

unit EAGF-P1

→ www.festo.com/eagf-p1

Electric cylinders EPCO, with spindle drive

Technical data



Payload m as a function of speed v and acceleration a

Vertical mounting position

The moving tare weight of the guide unit (EPCO-...-KF) results in lower acceleration values with identical payload and speed.

EPCO-40-5P

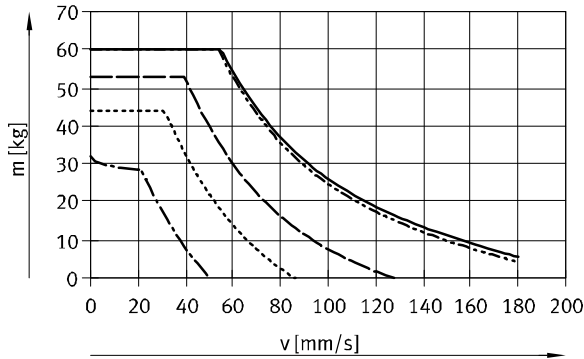

For EPCO-...	For EPCO-...-KF
— a = 0 m/s ²	a = 0 m/s ²
- - - a = 0.2 m/s ²	a = 2.4 m/s ²
- · - a = 2.5 m/s ²	a = 4.8 m/s ²
- · · - a = 5 m/s ²	a = 9.7 m/s ²
- · · · - a = 10 m/s ²	

EPCO-40-12.7P

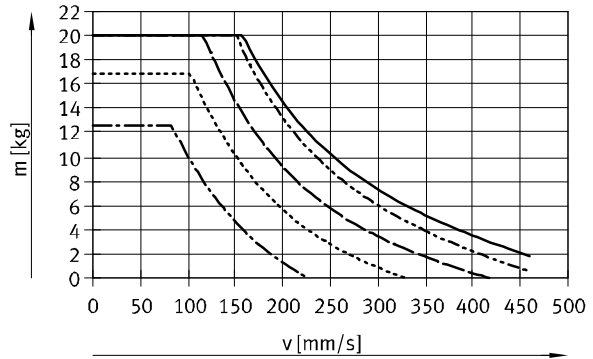

For EPCO-...	For EPCO-...-KF
— a = 0 m/s ²	a = 0 m/s ²
- - - a = 1.2 m/s ²	a = 1.8 m/s ²
- · - a = 2.5 m/s ²	a = 4.0 m/s ²
- · · - a = 5 m/s ²	a = 8.5 m/s ²
- · · · - a = 10 m/s ²	

Payload m as a function of travel distance l and positioning time t

Horizontal mounting position

The moving tare weight of the guide unit (EPCO-...-KF) results in longer positioning times with identical payload and travel distance.

EPCO-16-3P

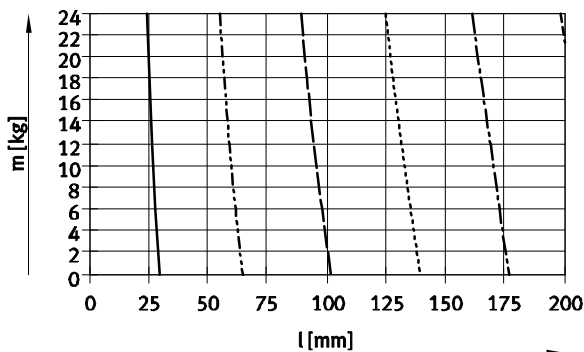

For EPCO-...	For EPCO-...-KF
— t = 0.30 s	t = 0.30 s
- - - t = 0.60 s	t = 0.60 s
- · - t = 0.90 s	t = 0.90 s
- · · - t = 1.20 s	t = 1.20 s
- · · · - t = 1.50 s	t = 1.55 s
- · · · - t = 1.80 s	t = 1.85 s

EPCO-16-8P

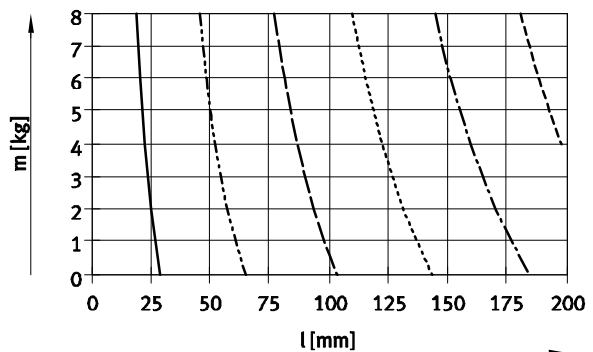

For EPCO-...	For EPCO-...-KF
— t = 0.15 s	t = 0.15 s
- - - t = 0.30 s	t = 0.30 s
- · - t = 0.45 s	t = 0.45 s
- · · - t = 0.60 s	t = 0.65 s
- · · · - t = 0.75 s	t = 0.80 s
- · · · - t = 0.90 s	t = 0.95 s

Further technical data for the guide unit EAGF-P1

→ www.festo.com/eagf-p1

Electric cylinders EPCO, with spindle drive

Technical data

Payload m as a function of travel distance l and positioning time t

Horizontal mounting position

The moving tare weight of the guide unit (EPCO-...-KF) results in longer positioning times with identical payload and travel distance.

EPCO-25-3P

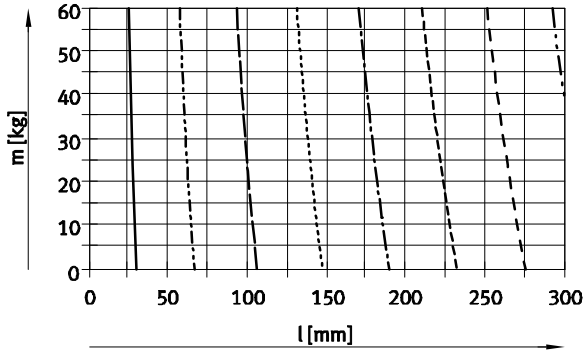

For EPCO-...	For EPCO-...-KF
— t = 0.30 s	— t = 0.30 s
- - - t = 0.60 s	- - - t = 0.60 s
- · - t = 0.90 s	- · - t = 0.90 s
- · · - t = 1.20 s	- · · - t = 1.20 s
- · · · - t = 1.50 s	- · · · - t = 1.50 s
- · · · - t = 1.80 s	- · · · - t = 1.80 s
- · · · - t = 2.10 s	- · · · - t = 2.10 s
- · · · - t = 2.40 s	- · · · - t = 2.40 s

EPCO-25-10P

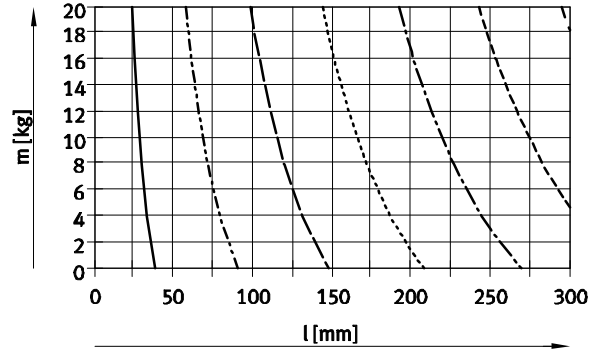

For EPCO-...	For EPCO-...-KF
— t = 0.15 s	— t = 0.15 s
- - - t = 0.30 s	- - - t = 0.30 s
- · - t = 0.45 s	- · - t = 0.45 s
- · · - t = 0.60 s	- · · - t = 0.60 s
- · · - t = 0.75 s	- · · - t = 0.80 s
- · · - t = 0.90 s	- · · - t = 0.95 s
- · · - t = 1.05 s	- · · - t = 1.10 s

EPCO-40-5P

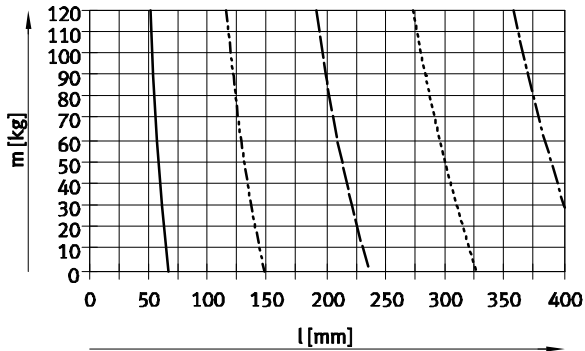

For EPCO-...	For EPCO-...-KF
— t = 0.50 s	— t = 0.50 s
- - - t = 1.00 s	- - - t = 1.00 s
- · - t = 1.50 s	- · - t = 1.55 s
- · · - t = 2.00 s	- · · - t = 2.05 s
- · · - t = 2.50 s	- · · - t = 2.55 s

EPCO-40-12.7P

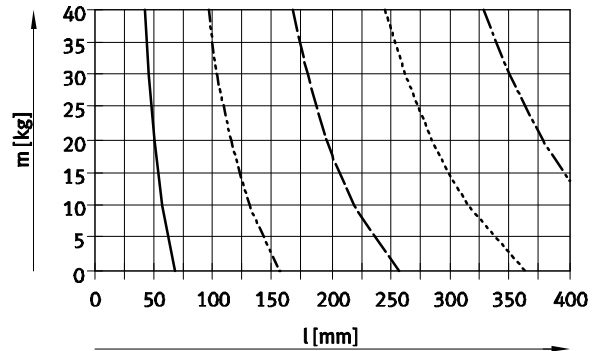

For EPCO-...	For EPCO-...-KF
— t = 0.25 s	— t = 0.25 s
- - - t = 0.50 s	- - - t = 0.50 s
- · - t = 0.75 s	- · - t = 0.80 s
- · · - t = 1.00 s	- · · - t = 1.05 s
- · · - t = 1.25 s	- · · - t = 1.30 s

Further technical data for the guide unit EAGF-P1

➔ www.festo.com/eagf-p1

Electric cylinders EPCO, with spindle drive

Technical data



Payload m as a function of travel distance l and positioning time t

Vertical mounting position

The moving tare weight of the guide unit (EPCO-...-KF) results in longer positioning times with identical payload and travel distance.

EPCO-16-3P

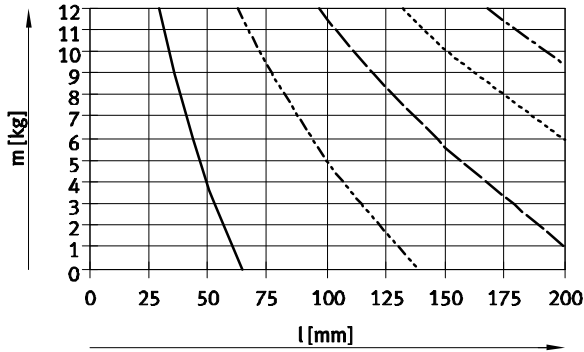

For EPCO-...	For EPCO-...-KF
— t = 0.60 s	t = 0.60 s
- - - t = 1.20 s	t = 1.25 s
- · - t = 1.80 s	t = 1.85 s
- · · - t = 2.40 s	t = 2.50 s
- · · · - t = 3.00 s	t = 3.10 s

EPCO-16-8P

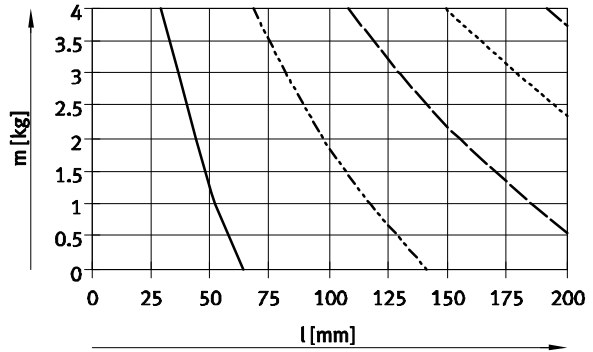

For EPCO-...	For EPCO-...-KF
— t = 0.30 s	t = 0.35 s
- - - t = 0.60 s	t = 0.65 s
- · - t = 0.90 s	t = 1.00 s
- · · - t = 1.20 s	t = 1.30 s
- · · · - t = 1.50 s	t = 1.65 s

EPCO-25-3P

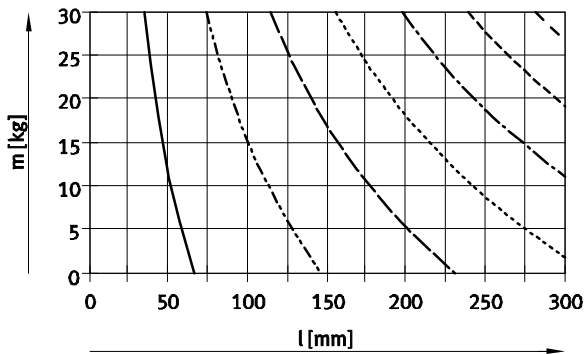

For EPCO-...	For EPCO-...-KF
— t = 0.60 s	t = 0.60 s
- - - t = 1.20 s	t = 1.20 s
- · - t = 1.80 s	t = 1.85 s
- · · - t = 2.40 s	t = 2.45 s
- · · · - t = 3.00 s	t = 3.05 s
- · · · · - t = 3.60 s	t = 3.70 s
- · · · · · - t = 4.20 s	t = 4.30 s

EPCO-25-10P

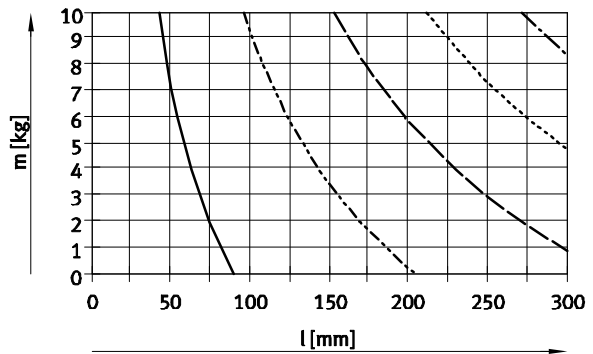

For EPCO-...	For EPCO-...-KF
— t = 0.30 s	t = 0.30 s
- - - t = 0.60 s	t = 0.65 s
- · - t = 0.90 s	t = 0.95 s
- · · - t = 1.20 s	t = 1.25 s
- · · · - t = 1.50 s	t = 1.60 s

Further technical data for the guide

unit EAGF-P1

→ www.festo.com/eagf-p1

Electric cylinders EPCO, with spindle drive

Technical data

Payload m as a function of travel distance l and positioning time t

Vertical mounting position

The moving tare weight of the guide unit (EPCO-...-KF) results in longer positioning times with identical payload and travel distance.

EPCO-40-5P

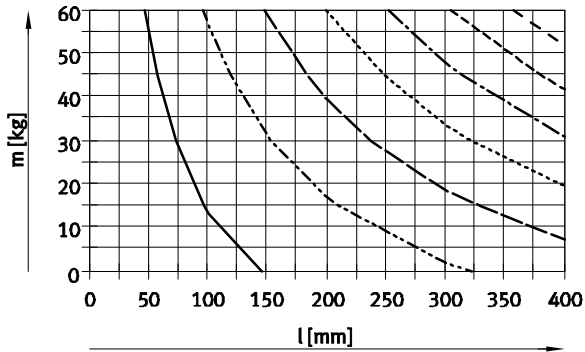

For EPCO-...	For EPCO-...-KF
— t = 1.00 s	- - - t = 1.05 s
- - - t = 2.00 s	- - - t = 2.05 s
- - - t = 3.00 s	- - - t = 3.10 s
- - - t = 4.00 s	- - - t = 4.10 s
- - - t = 5.00 s	- - - t = 5.15 s
- - - t = 6.00 s	- - - t = 6.20 s
- - - t = 7.00 s	- - - t = 7.20 s

EPCO-40-12.7P

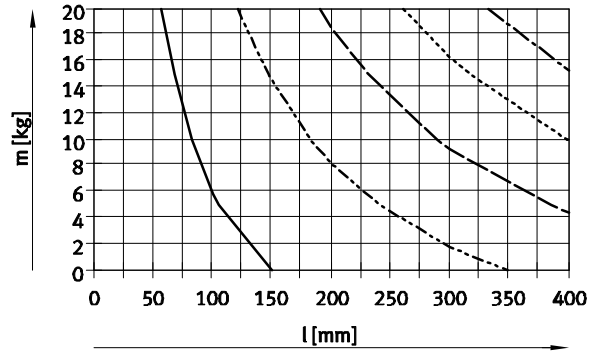

For EPCO-...	For EPCO-...-KF
— t = 0.50 s	- - - t = 0.55 s
- - - t = 1.00 s	- - - t = 1.10 s
- - - t = 1.50 s	- - - t = 1.60 s
- - - t = 2.00 s	- - - t = 2.15 s
- - - t = 2.50 s	- - - t = 2.70 s

Feed force F as a function of speed v and acceleration a

The moving tare weight of the guide unit (EPCO-...-KF) results in lower acceleration values with identical feed force and speed.

EPCO-16-3P

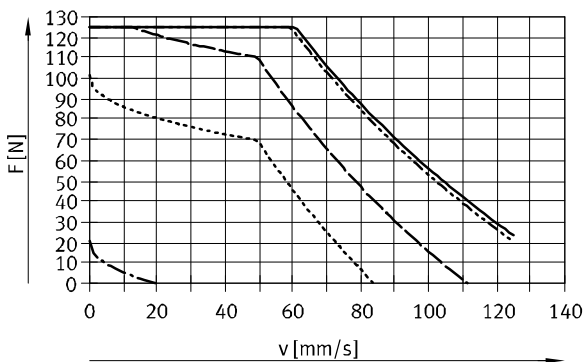

For EPCO-...	For EPCO-...-KF
— a = 0 m/s ²	- - - a = 0 m/s ²
- - - a = 0.2 m/s ²	- - - a = 2.3 m/s ²
- - - a = 2.5 m/s ²	- - - a = 4.7 m/s ²
- - - a = 5 m/s ²	- - - a = 9.6 m/s ²
- - - a = 10 m/s ²	

EPCO-16-8P

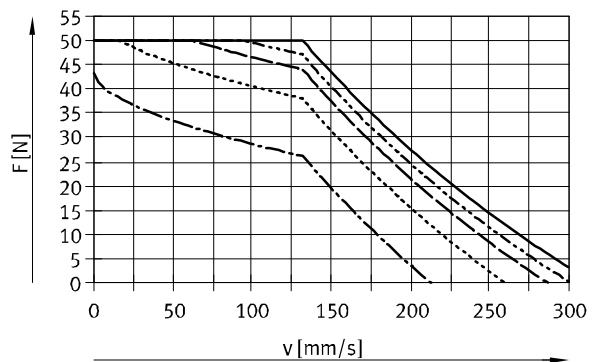

For EPCO-...	For EPCO-...-KF
— a = 0 m/s ²	- - - a = 0 m/s ²
- - - a = 1.2 m/s ²	- - - a = 1.2 m/s ²
- - - a = 2.5 m/s ²	- - - a = 3.4 m/s ²
- - - a = 5 m/s ²	- - - a = 7.8 m/s ²
- - - a = 10 m/s ²	

Further technical data for the guide unit EAGF-P1
 → www.festo.com/eagf-p1

Electric cylinders EPCO, with spindle drive

Technical data



Feed force F as a function of speed v and acceleration a

The moving tare weight of the guide unit (EPCO-...-KF) results in lower acceleration values with identical feed force and speed.

EPCO-25-3P

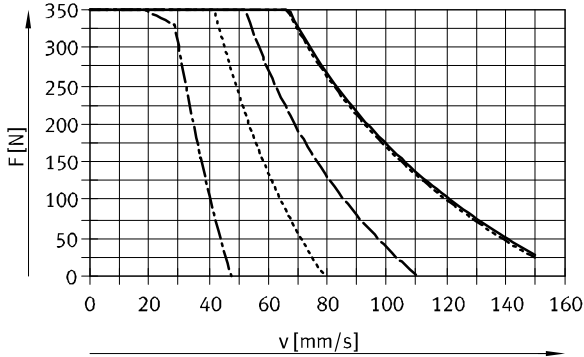

For EPCO-...	For EPCO-...-KF
— a = 0 m/s ²	a = 0 m/s ²
- - - a = 0.2 m/s ²	a = 2.4 m/s ²
— a = 2.5 m/s ²	a = 4.9 m/s ²
- - - a = 5 m/s ²	a = 9.8 m/s ²
— a = 10 m/s ²	

EPCO-25-10P

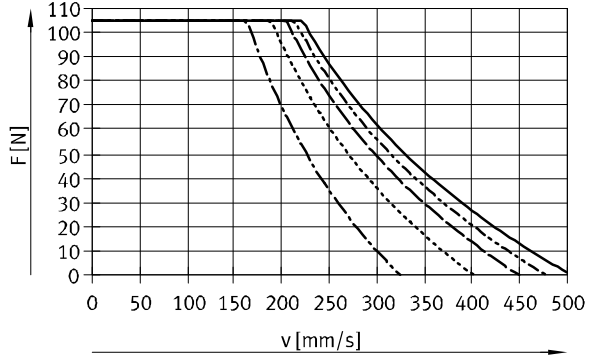

For EPCO-...	For EPCO-...-KF
— a = 0 m/s ²	a = 0 m/s ²
- - - a = 1.2 m/s ²	a = 1.6 m/s ²
— a = 2.5 m/s ²	a = 3.9 m/s ²
- - - a = 5 m/s ²	a = 8.3 m/s ²
— a = 10 m/s ²	

EPCO-40-5P

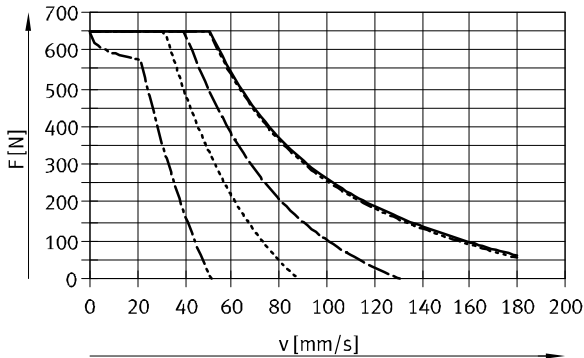

For EPCO-...	For EPCO-...-KF
— a = 0 m/s ²	a = 0 m/s ²
- - - a = 0.2 m/s ²	a = 2.4 m/s ²
— a = 2.5 m/s ²	a = 4.8 m/s ²
- - - a = 5 m/s ²	a = 9.7 m/s ²
— a = 10 m/s ²	

EPCO-40-12.7P

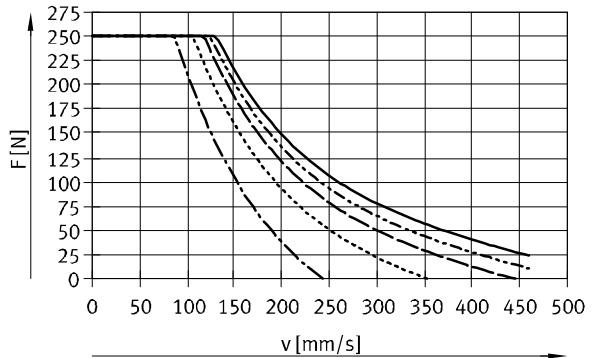

For EPCO-...	For EPCO-...-KF
— a = 0 m/s ²	a = 0 m/s ²
- - - a = 1.2 m/s ²	a = 1.8 m/s ²
— a = 2.5 m/s ²	a = 4.0 m/s ²
- - - a = 5 m/s ²	a = 8.5 m/s ²
— a = 10 m/s ²	

Further technical data for the guide unit EAGF-P1

→ www.festo.com/eagf-p1

Electric cylinders EPCO, with spindle drive

Technical data

Calculating the mean feed force F_{xm} with the electric cylinder EPCO

The peak feed force value must not exceed the maximum feed force within a movement cycle. The peak value is generally achieved in vertical

operation during the acceleration phase of the upwards stroke. If the maximum feed force is exceeded, this can increase wear and thus shorten

the service life of the ball screw spindle. The maximum speed must likewise not be exceeded.

$$F_x \leq F_{x\max}$$

and

$$v_x \leq v_{x\max}$$

Mean feed force (to DIN 69051-4)

During operation, the continuous feed force may be briefly exceeded up to

the maximum feed force. The continuous feed force must, however, be

adhered to when averaged over a movement cycle.

$$F_{xm} \leq F_{xdauer}$$

$$F_{xm} = \sqrt[3]{\sum F_x^3 \times \frac{v_x}{v_{xm}} \times \frac{q}{100}} =$$

$$F_{xm} = \sqrt[3]{F_{x1}^3 \times \frac{v_{x1}}{v_{xm}} \times \frac{q_1}{100} + F_{x2}^3 \times \frac{v_{x2}}{v_{xm}} \times \frac{q_2}{100} + F_{x3}^3 \times \frac{v_{x3}}{v_{xm}} \times \frac{q_3}{100} + \dots}$$

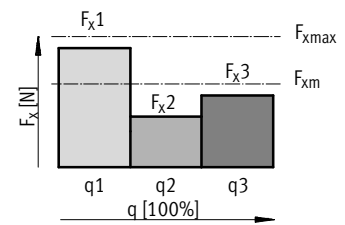

Mean feed speed (to DIN 69051-4)

$$v_{xm} = \sum v_x \times \frac{q}{100} = v_{x1} \times \frac{q_1}{100} + v_{x2} \times \frac{q_2}{100} + v_{x3} \times \frac{q_3}{100} + \dots$$

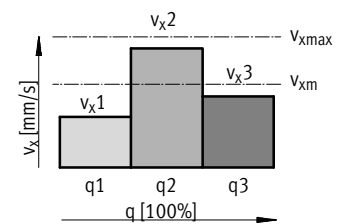

F_x	Feed force	v_x	Feed speed
F_{xm}	Mean feed force	v_{xm}	Mean feed speed
$F_{x\max}$	Max. feed force	$v_{x\max}$	Max. feed speed
$F_{x\text{continuous}}$	Continuous feed force		
q	Time		

Electric cylinders EPCO, with spindle drive

Technical data



Mean feed force F as a function of running performance L (to DIN 69051-4)

EPCO-16

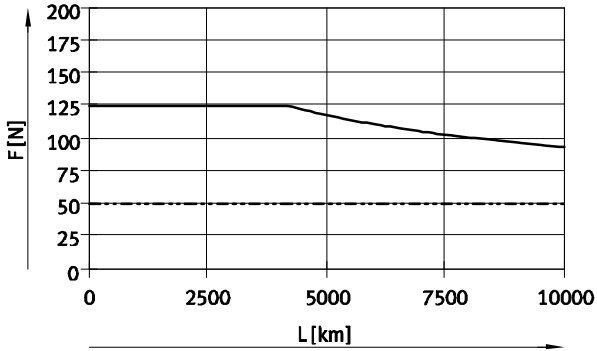

— EPCO-16-3P
- - - EPCO-16-8P

EPCO-25

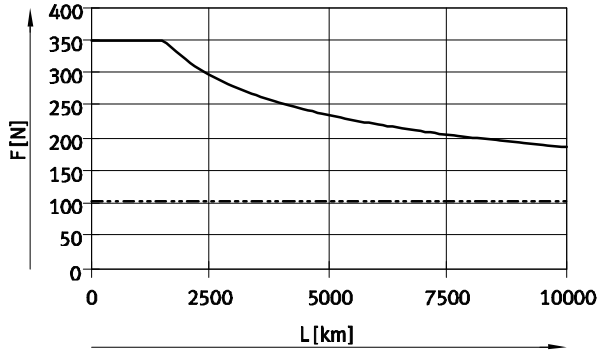

— EPCO-25-3P
- - - EPCO-25-10P

EPCO-40

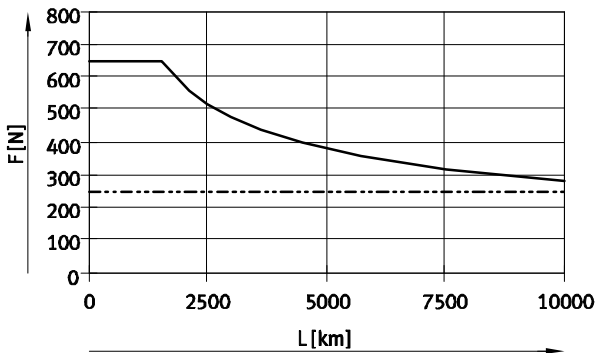

— EPCO-40-5P
- - - EPCO-40-12.7P

 Note

- The specifications for running performance are based on experimentally determined and theoretically calculated data. The running performance attainable in practice can deviate considerably from the specified curves under different parameters.

Pin allocation

Motor

EPCO-16

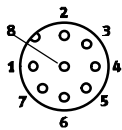

EPCO-25/-40

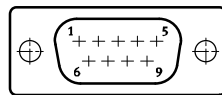

Encoder

EPCO-16/-25/-40

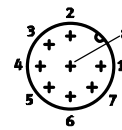

PIN	Function
1	String A
2	String A/
3	String B
4	String B/
5	n.c.
6	n.c.
7	Brake +24 V DC ¹⁾
8	Brake GND ¹⁾
-	-

PIN	Function
1	String A
2	String A/
3	String B
4	String B/
5	n.c.
6	n.c.
7	Brake +24 V DC ¹⁾
8	Brake GND ¹⁾
9	n.c.

PIN	Function
1	Signal trace A
2	Signal trace A/
3	Signal trace B
4	Signal trace B/
5	GND encoder
6	Signal trace N
7	Signal trace N/
8	VCC auxiliary supply +5 V
GND	Shield on plug housing

1) Only on motors with brake.

Electric cylinders EPCO, with spindle drive

Technical data



Dimensions

Download CAD data → www.festo.com

Size 16

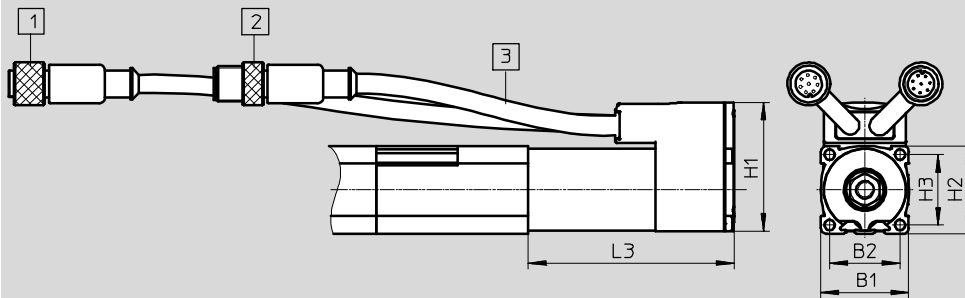

- 1 Motor connection:
Round plug M12, 8-pin, socket
cable length: 350 mm
- 2 Encoder connection:
Round plug M12, 8-pin, pins
cable length: 250 mm
- 3 Min. bending radius of the
cables: 60 mm

Size 25, 40

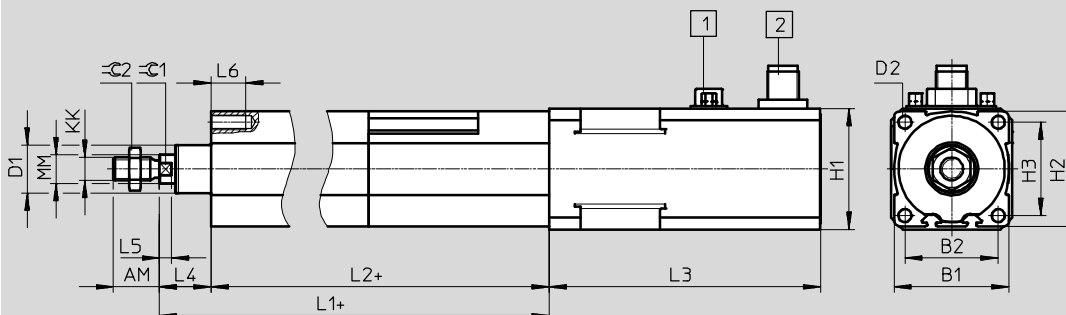

- 1 Motor connection:
SUB-D plug, 9-pin, pins
- 2 Encoder connection:
Round plug M12, 8-pin, pins
- + = plus stroke length

Size	AM	B1	B2	D1	D2	H1	H2	H3	KK	L1	L2
[mm]	-0.5			∅ ±0.05	∅						±1
16	12	30	24	13.27	M4	44	30	24	M6	143	127
25	16	40	32.5	17.27	M5	42 ^{+0.3}	40	32.5	M8	174.6	156.6
40	19	55	42	26.52	M6	56.4	55	42	M10x1.25	214.2	192.7

Size	L3				L4	L5	L6	MM	≅C1	≅C2
	EPCO-...									
[mm]	-E	-B	-EB		-0.15		-0.1			
16	70±1	70±1	96±1.5	96±1.5	16	3.7	10	8	7	10
25	66±1	94.4±1.2	114.4±1.3	127.4±1.3	18	4.2	12	10	9	13
40	73.5±0.8	102.5±1.1	123.5±1.1	138±1.1	21.5	4.7	14	12	10	17

Electric cylinders EPCO, with spindle drive

Technical data

Dimensions Download CAD data → www.festo.com

Variants
 E – Extended piston rod F – Female piston rod thread

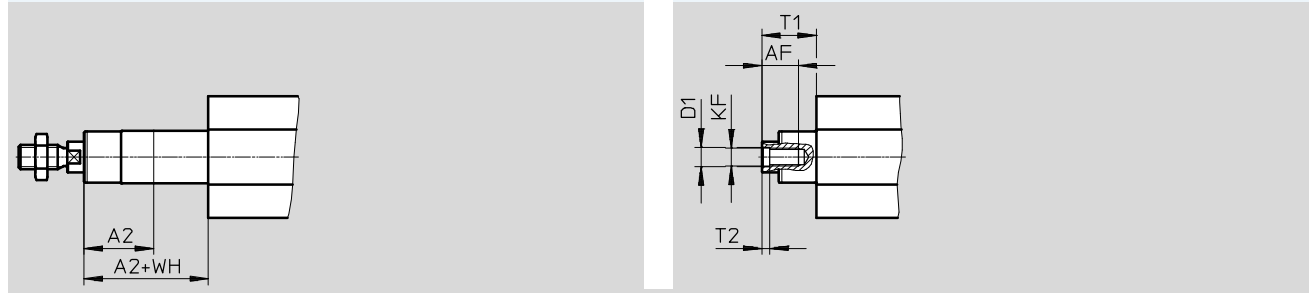

Size [mm]	A2 max.	AF	KF	T1	T2	D1	WH
16	100	10	M4	16	1.5	4.3	16
25	150	12	M6	18	2.6	6.4	18
40	200	14	M8	21.5	3.3	8.4	21.5

Electric cylinders EPCO, with spindle drive

Technical data

FESTO

★ Core product range

Ordering data – EPCO-16 (stock items)			Ordering data – EPCO-16 (stock items)		
Stroke [mm]	Part No.	Type	Stroke [mm]	Part No.	Type
Spindle pitch 3 mm, with encoder			Spindle pitch 8 mm, with encoder		
50	★ 1476415	EPCO-16-50-3P-ST-E	50	★ 1476522	EPCO-16-50-8P-ST-E
100	★ 1476417	EPCO-16-100-3P-ST-E	100	★ 1476524	EPCO-16-100-8P-ST-E
150	★ 1476419	EPCO-16-150-3P-ST-E	150	★ 1476526	EPCO-16-150-8P-ST-E
200	★ 1476421	EPCO-16-200-3P-ST-E	200	★ 1476528	EPCO-16-200-8P-ST-E

Ordering data – EPCO-25 (stock items)			Ordering data – EPCO-25 (stock items)		
Stroke [mm]	Part No.	Type	Stroke [mm]	Part No.	Type
Spindle pitch 3 mm, with encoder			Spindle pitch 10 mm, with encoder		
50	★ 1470698	EPCO-25-50-3P-ST-E	50	★ 1470769	EPCO-25-50-10P-ST-E
100	★ 1470700	EPCO-25-100-3P-ST-E	100	★ 1470771	EPCO-25-100-10P-ST-E
150	★ 1470702	EPCO-25-150-3P-ST-E	150	★ 1470773	EPCO-25-150-10P-ST-E
200	★ 1470704	EPCO-25-200-3P-ST-E	200	★ 1470775	EPCO-25-200-10P-ST-E
300	★ 1470706	EPCO-25-300-3P-ST-E	300	★ 1470777	EPCO-25-300-10P-ST-E

Ordering data – EPCO-40 (stock items)			Ordering data – EPCO-40 (stock items)		
Stroke [mm]	Part No.	Type	Stroke [mm]	Part No.	Type
Spindle pitch 5 mm, with encoder			Spindle pitch 12.7 mm, with encoder		
50	★ 1472501	EPCO-40-50-5P-ST-E	50	★ 1472617	EPCO-40-50-12.7P-ST-E
100	★ 1472503	EPCO-40-100-5P-ST-E	100	★ 1472619	EPCO-40-100-12.7P-ST-E
150	★ 1472505	EPCO-40-150-5P-ST-E	150	★ 1472621	EPCO-40-150-12.7P-ST-E
200	★ 1472507	EPCO-40-200-5P-ST-E	200	★ 1472623	EPCO-40-200-12.7P-ST-E
300	★ 1472509	EPCO-40-300-5P-ST-E	300	★ 1472625	EPCO-40-300-12.7P-ST-E

 Note
 Variants ordered via modular product system → page 26

 Note
 Position sensing is only possible in combination with feature "A" (position sensing) → page 26 (modular product system)

Festo core product range

- ★ Ready for dispatch from the Festo factory in 24 hours
- ☆ Ready for dispatch in 5 days maximum from stock

Electric cylinders EPCO, with spindle drive

Ordering data – Modular products

Ordering table							
Size	16	25	40	Condi- tions	Code	Enter code	
M Module no.	1476585	1470874	1472887				
Function	Electric cylinder				EPCO	EPCO	
Size	16	25	40		★ -...		
Stroke [mm]	50				★ -...		
	75				-...		
	100				★ -...		
	125				-...		
	150				★ -...		
	175				-...		
	200				★ -...		
	-	250				-...	
	-	300				★ -...	
	-			350		-...	
-			400		-...		
Spindle pitch [mm]	3	3			★ -...P		
			5				
	8						
		10					
			12.7				
O Piston rod thread type	Male thread				★		
	Female thread				-F		
Piston rod extension [mm]	None				★		
	1 ... 100	1 ... 150	1 ... 200		-...E		
Position sensing	None				★		
	Via proximity sensor			¹	-A		
M Motor type	Stepper motor				★ -ST	ST	

¹ A Must be selected if encoder E is not selected.

- M** Mandatory data
- O** Options

Transfer order code

Festo core product range

- ★ Ready for dispatch from the Festo factory in 24 hours
- ★ Ready for dispatch in 5 days maximum from stock

Electric cylinders EPCO, with spindle drive

Ordering data – Modular products

Ordering table						
Size	16	25	40	Condi- tions	Code	Enter code
0 Measuring unit	None					
	Encoder				★ -E	
Brake	None				★	
	Brake				B	
Cable outlet direction	Top (standard)				★	
	Underneath				★ -D	
	Left				★ -L	
	Right				★ -R	
Guide unit	None				★	
	Recirculating ball bearing guide with two guide rods			2	★ -KF	
Connecting cable to motor controller, suitable for use with energy chains	None				★	
	1.5 m, straight plug				★ +1.5E	
	1.5 m, angled plug			3	★ +1.5EA	
	2.5 m, straight plug			3	★ +2.5E	
	2.5 m, angled plug			3	★ +2.5EA	
	5 m, straight plug			3	★ +5E	
	5 m, angled plug			3	★ +5EA	
	7 m, straight plug			3	★ +7E	
	7 m, angled plug			3	★ +7EA	
	10 m, straight plug			3	★ +10E	
10 m, angled plug			3	★ +10EA		
Controller type	None				★	
	CMMQ, 5 A				★ +C5	
Bus protocol/activation	None				★	
	Digital I/O interface			4	★ DIO	
	IO-Link			4	★ LK	
Switching input/output	None				★	
	NPN			4 5	★ N	
	PNP			4	★ P	

- 2 KF Not with piston rod extension ...E
- 3 1.5E, 1.5EA, 2.5E, 2.5EA, 5E, 5EA, 7E, 7EA, 10E, 10EA, C5 Only with encoder E
- 4 DIO, LK, N, P Must be selected if controller type +C5 is selected
- 5 N Not with IO-Link LK

- M Mandatory data
- 0 Options

Transfer order code

- - + +

Festo core product range

- ★ Ready for dispatch from the Festo factory in 24 hours
- ☆ Ready for dispatch in 5 days maximum from stock

Electric cylinders EPCO, with spindle drive

Accessories



Foot mounting EAHF

Material:

Galvanised steel

RoHS-compliant

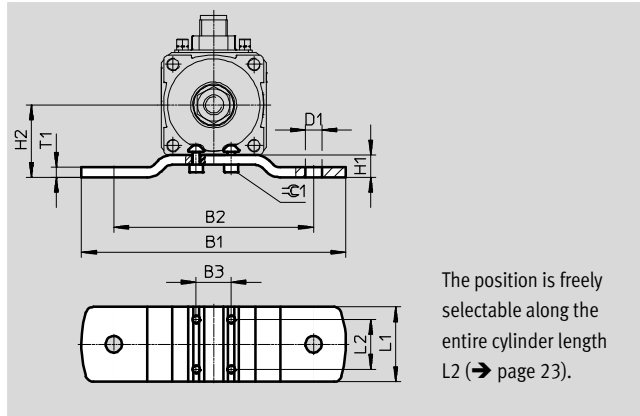

Dimensions and ordering data							
For size	B1	B2	B3	D1 Ø	H1	H2	L1
[mm]							
16	86	60	10	5.5	7	22	30
25	106	80	14	6.6	9	29	30
40	130	100	18	9	10.5	38	40

For size	L2	T1	≈C1	CRC ¹⁾	Weight [g]	Part No.	Type
[mm]							
16	20	3	2.5	1	60	1434903	EAHF-P1-16
25	20	4	2.5	1	100	1434904	EAHF-P1-25
40	20	4	4	1	160	1434905	EAHF-P1-40

1) Corrosion resistance class CRC 1 to Festo standard FN 940070
 Low corrosion stress. For dry indoor applications or transport and storage protection. Also applies to parts behind covers, in the non-visible interior area, and parts which are covered in the application (e.g. drive trunnions).

Electric cylinders EPCO, with spindle drive

Accessories

Flange mounting EAHH

Material:
Galvanised steel
RoHS-compliant

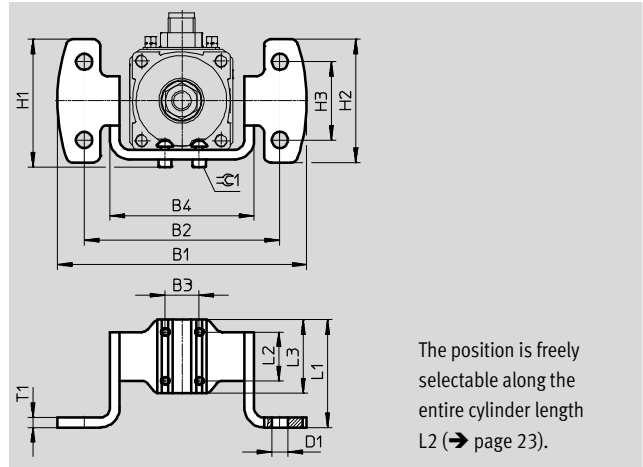

Dimensions and ordering data									
For size	B1	B2	B3	B4	D1 ∅	H1	H2	H3	L1
[mm]									
16	77.2	60	10	45	5.5	38.3	34.6	20	43
25	102	80	14	59	6.6	52.3	50.6	32	44
40	119	100	18	76	9	64.5	56	36	54

For size	L2	L3	T1	≈C1	CRC ¹⁾	Weight	Part No.	Type
[mm]						[g]		
16	20	30	3	2.5	1	80	1434906	EAHH-P1-16
25	20	30	4	2.5	1	150	1434907	EAHH-P1-25
40	20	40	4	4	1	240	1434908	EAHH-P1-40

1) Corrosion resistance class CRC 1 to Festo standard FN 940070
Low corrosion stress. For dry indoor applications or transport and storage protection. Also applies to parts behind covers, in the non-visible interior area, and parts which are covered in the application (e.g. drive trunnions).

Electric cylinders EPCO, with spindle drive

Accessories



Swivel mounting EAHS

Material:

Galvanised steel

RoHS-compliant

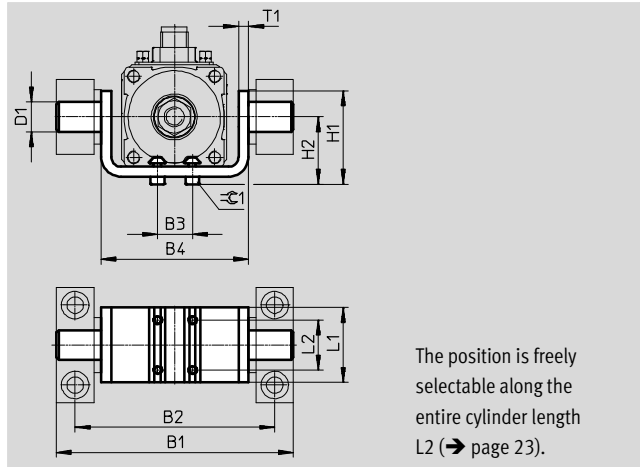

The position is freely selectable along the entire cylinder length L2 (→ page 23).

Dimensions and ordering data							
For size	B1	B2	B3	B4	D1	H1	H2
[mm]					∅ e9		
16	71	60	10	45	8	33	21
25	95	80	14	59	12	37.5	27
40	118	100	18	76	16	55	36.5

For size	L1	L2	T1	≈C1	CRC ¹⁾	Weight	Part No.	Type
[mm]						[g]		
16	30	20	3	2.5	1	80	1434909	EAHS-P1-16
25	30	20	4	2.5	1	140	1434910	EAHS-P1-25
40	40	20	4	4	1	260	1434911	EAHS-P1-40

1) Corrosion resistance class CRC 1 to Festo standard FN 940070
 Low corrosion stress. For dry indoor applications or transport and storage protection. Also applies to parts behind covers, in the non-visible interior area, and parts which are covered in the application (e.g. drive trunnions).

Electric cylinders EPCO, with spindle drive

Accessories

Adapter kit EAHA

Material:

Galvanised steel

RoHS-compliant

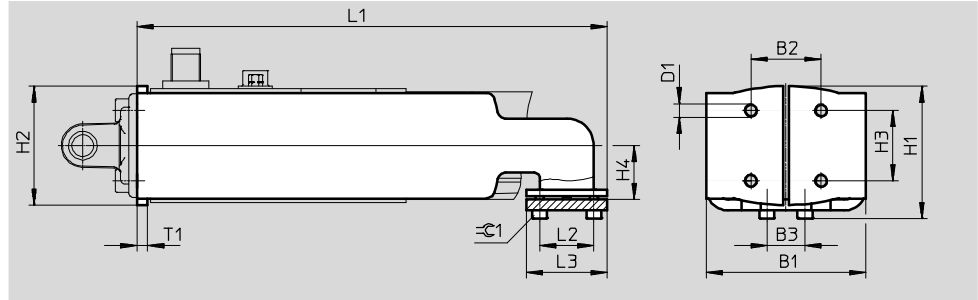

Dimensions and ordering data								
For size	B1	B2	B3	D1	H1	H2	H3	H4
[mm]								
16	45	18	10	M4	35.9	29.8	18	15
25	59	26	14	M5	49	44	26	20
40	76	38	18	M6	66.9	60.8	38	27.5

For size	L1	L2	L3	T1	⌀C1	CRC ¹⁾	Weight	Part No.	Type
[mm]							[g]		
16	139	20	30	3	2.5	1	210	★ 1434900	EAHA-P1-16
25	174	20	30	4	2.5	1	480	★ 1434901	EAHA-P1-25
40	193.4	20	40	4	4	1	770	★ 1434902	EAHA-P1-40

1) Corrosion resistance class CRC 1 to Festo standard FN 940070

Low corrosion stress. For dry indoor applications or transport and storage protection. Also applies to parts behind covers, in the non-visible interior area, and parts which are covered in the application (e.g. drive trunnions).

Electric cylinders EPCO, with spindle drive

Accessories



Trunnion flange ZNCF

Material:
ZNCF: Stainless steel casting

Free of copper and PTFE
RoHS-compliant

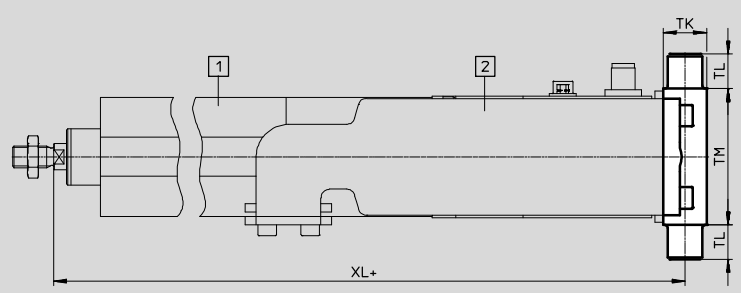
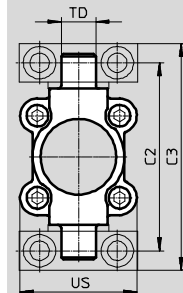

- 1 Electric cylinder EPCO
- 2 Adapter kit EAHA
- + = plus stroke length

The trunnion flange ZNCF cannot be mounted when turned by 90°.

Dimensions and ordering data															
For size	C2	C3	TD	TK	TL	TM	US	XL			CRC ¹⁾	Weight	Part No.	Type	
[mm]			∅ e9					EPCO-...	-E	-B	-EB		[g]		
40	87	105	16	20	16	63	54	306.7	335.7	356.7	371.2	2	285	174412	ZNCF-40

1) Corrosion resistance class CRC 2 to Festo standard FN 940070
Moderate corrosion stress. Indoor applications in which condensation may occur. External visible parts with primarily decorative requirements for the surface and which are in direct contact with the ambient atmosphere typical for industrial applications.

Trunnion support LNZG

Material:
Trunnion support: Anodised aluminium
Plain bearing: Plastic
Free of copper and PTFE
RoHS-compliant

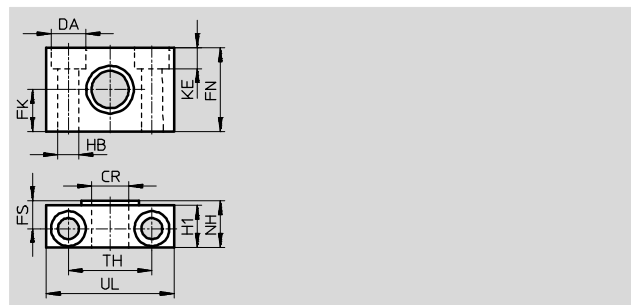
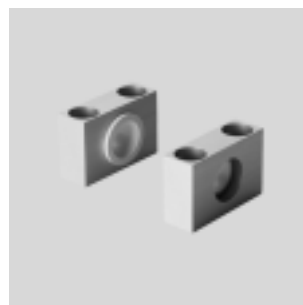

Dimensions and ordering data															
For size	CR	DA	FK	FN	FS	H1	HB	KE	NH	TH	UL	CRC ¹⁾	Weight	Part No.	Type
[mm]	∅ D11	∅ H13	∅ ±0.1				∅ H13			±0.2			[g]		
16	8	8	10	20	7.5	11	4.5	4.6	13	20	30	2	26	1434912	LNZG-16
25	12	11	15	30	10.5	15	6.6	6.8	18	32	46	2	83	32959	LNZG-32
40	16	15	18	36	12	18	9	9	21	36	55	2	129	32960	LNZG-40/50

1) Corrosion resistance class CRC 2 to Festo standard FN 940070
Moderate corrosion stress. Indoor applications in which condensation may occur. External visible parts with primarily decorative requirements for the surface and which are in direct contact with the ambient atmosphere typical for industrial applications.

Electric cylinders EPCO, with spindle drive

Accessories



Swivel flange SNCS



Material:
Die-cast aluminium

Free of copper and PTFE
RoHS-compliant

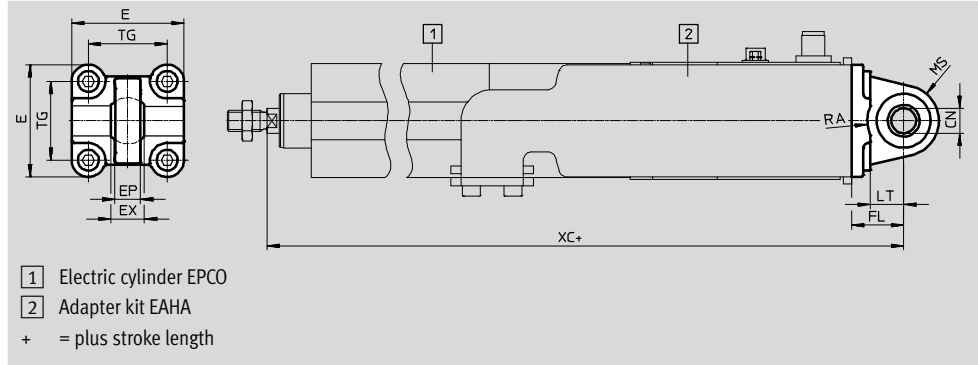

Dimensions and ordering data

For size	CN	E	EP	EX	FL	LT	MS	RA	TG
[mm]	∅		+0.2		±0.2			+1	
40	12+0.015	54-0.5	12	16	25	16	17+0.5	17.5	38

For size	XC				CRC ¹⁾	Weight	Part No.	Type
	EPCO-...	-E	-B	-EB				
[mm]						[g]		
40	321.7	350.7	371.7	386.2	2	122	★ 174398	SNCS-40

1) Corrosion resistance class CRC 2 to Festo standard FN 940070

Moderate corrosion stress. Indoor applications in which condensation may occur. External visible parts with primarily decorative requirements for the surface and which are in direct contact with the ambient atmosphere typical for industrial applications.

Swivel flange SNCL



Material:
Wrought aluminium alloy

Free of copper and PTFE
RoHS-compliant

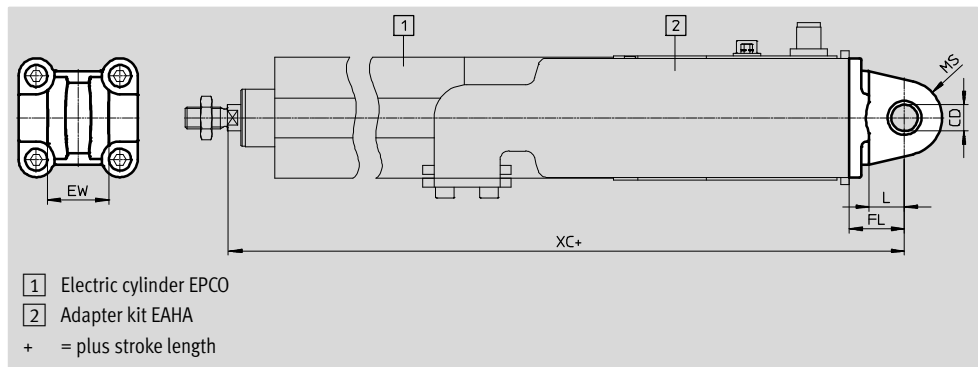

Dimensions and ordering data

For size	CD	EW	FL	L	MR	XC				CRC ¹⁾	Weight	Part No.	Type
						EPCO-...	-E	-B	-EB				
[mm]	∅	h12	±0.2		-0.5						[g]		
16	6	12	16	10	6	237	237	263	263	2	21	537791	SNCL-16
25	8	16	20	14	8	269.6	298	318	331	2	41	537793	SNCL-25
40	12	28	25	16	12	321.7	350.7	371.7	386.2	2	95	★ 174405	SNCL-40

1) Corrosion resistance class CRC 2 to Festo standard FN 940070

Moderate corrosion stress. Indoor applications in which condensation may occur. External visible parts with primarily decorative requirements for the surface and which are in direct contact with the ambient atmosphere typical for industrial applications.

Festo core product range

- ★ Ready for dispatch from the Festo factory in 24 hours
- ☆ Ready for dispatch in 5 days maximum from stock

Electric cylinders EPCO, with spindle drive

Accessories



Swivel flange SNCB

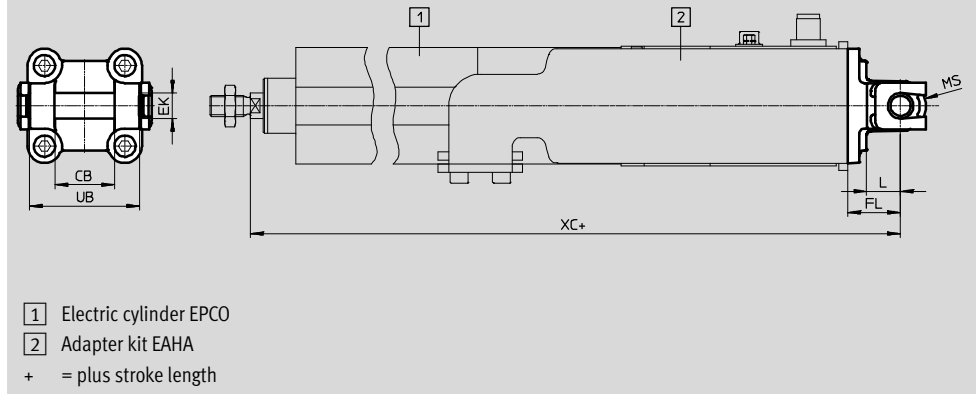

Material:
Die-cast aluminium

Free of copper and PTFE
RoHS-compliant

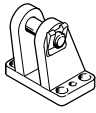
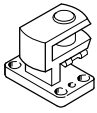

Dimensions and ordering data														
For size [mm]	CB	EK ∅	FL ±0.2	L	MR	UB h14	XC				CRC ¹⁾	Weight [g]	Part No.	Type
							EPCO-...							
							-E	-B	-EB					
40	28	12	25	16	12	52	321.7	350.7	371.7	386.2	2	155	★ 174391	SNCB-40

1) Corrosion resistance class CRC 2 to Festo standard FN 940070
Moderate corrosion stress. Indoor applications in which condensation may occur. External visible parts with primarily decorative requirements for the surface and which are in direct contact with the ambient atmosphere typical for industrial applications.

Ordering data – Mounting attachments				Technical data → Internet: clevis foot			
Designation	For size	Part No.	Type	Designation	For size	Part No.	Type
Clevis foot LBG				Right-angle clevis foot LQG			
	40	31762	LBG-40		40	31769	LQG-40
Clevis foot LBN							
	16	★ 6058	LBN-12/16				
	25	★ 6059	LBN-20/25				
	40	195861	LBN-40				





Festo core product range

- ★ Ready for dispatch from the Festo factory in 24 hours
- ☆ Ready for dispatch in 5 days maximum from stock

Electric cylinders EPCO, with spindle drive

Accessories

FESTO

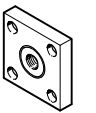
Ordering data – Piston rod attachments				Technical data → Internet: piston rod attachment			
Designation	For size	Part No.	Type	Designation	For size	Part No.	Type
Rod eye SGS				Rod clevis SG			
	16	★ 9254	SGS-M6		16	★ 3110	SG-M6
	25	★ 9255	SGS-M8		25	★ 3111	SG-M8
	40	★ 9261	SGS-M10x1,25		40	★ 6144	SG-M10x1,25
Self-aligning rod coupler FK				Rod clevis SGA			
	16	★ 2061	FK-M6		40	32954	SGA-M10x1,25
	25	★ 2062	FK-M8				
	40	★ 6140	FK-M10x1,25				
Coupling piece KSG							
	40	32963	KSG-M10x1,25				

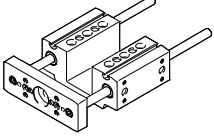
Ordering data – Guide unit			Technical data → Internet: eagf	
	For size	Stroke [mm]	Part No.	Type
	16	50	★ 3192932	EAGF-P1-KF-16-50
		100	★ 3192934	EAGF-P1-KF-16-100
		150	★ 3192936	EAGF-P1-KF-16-150
		200	★ 3192938	EAGF-P1-KF-16-200
		75, 125, 175	3192939	EAGF-P1-KF-16-
		25	50	★ 3192943
	25	100	★ 3192945	EAGF-P1-KF-25-100
		150	★ 3192947	EAGF-P1-KF-25-150
		200	★ 3192949	EAGF-P1-KF-25-200
		300	★ 3192951	EAGF-P1-KF-25-300
		75, 125, 175, 250	3192952	EAGF-P1-KF-25-
		40	50	★ 3192955
	100		★ 3192957	EAGF-P1-KF-40-100
	150		★ 3192959	EAGF-P1-KF-40-150
	200		★ 3192961	EAGF-P1-KF-40-200
	300		★ 3192963	EAGF-P1-KF-40-300
	75, 125, 175, 250, 350, 400		3192966	EAGF-P1-KF-40-

Festo core product range



- ★ Ready for dispatch from the Festo factory in 24 hours
- ☆ Ready for dispatch in 5 days maximum from stock

Electric cylinders EPCO, with spindle drive

Accessories

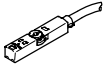
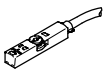
FESTO

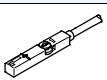
Ordering data – Proximity sensor for T-slot, magneto-resistive						Technical data → Internet: smt	
	Type of mounting	Switching output	Electrical connection	Cable length [m]	Part No.	Type	
N/O contact							
	Inserted in the slot from above, flush with the cylinder profile, short design	PNP	Cable, 3-wire	2.5	★ 574335	SMT-8M-A-PS-24V-E-2,5-OE	
			Plug M8x1, 3-pin	0.3	★ 574334	SMT-8M-A-PS-24V-E-0,3-M8D	
			Plug M12x1, 3-pin	0.3	★ 574337	SMT-8M-A-PS-24V-E-0,3-M12	
		NPN	Cable, 3-wire	2.5	★ 574338	SMT-8M-A-NS-24V-E-2,5-OE	
			Plug M8x1, 3-pin	0.3	★ 574339	SMT-8M-A-NS-24V-E-0,3-M8D	
N/C contact							
	Inserted in the slot from above, flush with the cylinder profile, short design	PNP	Cable, 3-wire	7.5	★ 574340	SMT-8M-A-PO-24V-E-7,5-OE	

Ordering data – Proximity sensor for T-slot, magnetic reed						Technical data → Internet: sme	
	Type of mounting	Switching output	Electrical connection	Cable length [m]	Part No.	Type	
N/O contact							
	Inserted in the slot from above, flush with the cylinder profile	Contacting	Cable, 3-wire	2.5	★ 543862	SME-8M-DS-24V-K-2,5-OE	
				5.0	★ 543863	SME-8M-DS-24V-K-5,0-OE	
			Cable, 2-wire	2.5	★ 543872	SME-8M-ZS-24V-K-2,5-OE	
			Plug M8x1, 3-pin	0.3	★ 543861	SME-8M-DS-24V-K-0,3-M8D	
	Inserted in the slot lengthwise, flush with the cylinder profile	Contacting	Cable, 3-wire	2.5	150855	SME-8-K-LED-24	
			Plug M8x1, 3-pin	0.3	150857	SME-8-S-LED-24	
N/C contact							
	Inserted in the slot lengthwise, flush with the cylinder profile	Contacting	Cable, 3-wire	7.5	160251	SME-8-0-K-LED-24	

-  - Note
 Position sensing is only possible in combination with feature "A" (position sensing) → page 26 (modular product system)

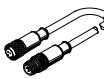
Ordering data – Connecting cable					Technical data → Internet: km8	
	Description	Connection	Cable length [m]	Part No.	Type	
Straight socket						
	Union nut M8, both ends	3-pin	0.5	★ 541346	NEBU-M8G3-K-0.5-M8G3	
			1.0	★ 541347	NEBU-M8G3-K-1-M8G3	
			2.5	★ 541348	NEBU-M8G3-K-2.5-M8G3	
			5.0	★ 541349	NEBU-M8G3-K-5-M8G3	

Festo core product range ★ Ready for dispatch from the Festo factory in 24 hours
 ☆ Ready for dispatch in 5 days maximum from stock

Electric cylinders EPCO, with spindle drive

Accessories

Sensor mounting

The sensor mountings can only be attached within the highlighted area due to the asymmetry of the internal magnets.

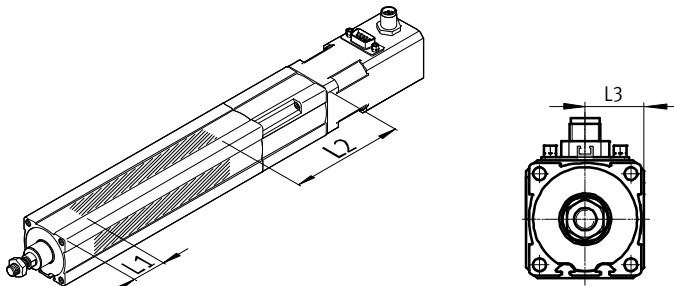

The proximity sensors may not switch reliably if they are mounted outside of this area.

The overall length of the sensor rail SAMH corresponds to the length of the sensing range plus approx. 10 mm adjustment range on either side for the proximity sensors.



Size	L1	L2	L3
16	29	95	15
25	33	121	20
40	40	150	27.5

Ordering data – Sensor mounting for T-slot

	For size	Description	Length [mm]	Part No.	Type
Sensor rail					
	16, 25, 40	Size 25 can only be used with proximity sensor SMT-8 (magneto-resistive).	50	1600093	SAMH-N8-SR-50
			100	1600118	SAMH-N8-SR-100
Mounting kit					
	16, 25, 40	-	35	525565	CRSMB-8-32/100

Electric cylinders EPCO, with spindle drive

Accessories

FESTO

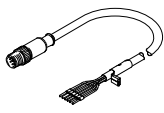
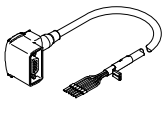
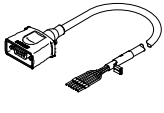
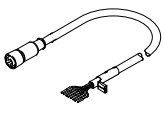
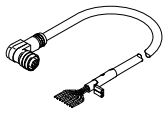
Ordering data – Cables ¹⁾					
	For size	Description	Cable length [m]	Part No.	Type
Motor cable					
	16	Straight plug			
		– Min. bending radius: 62 mm	1.5	★ 1449600	NEBM-SM12G8-E-1.5-Q5-LE6
		– Suitable for use with energy chains	2.5	★ 1449601	NEBM-SM12G8-E-2.5-Q5-LE6
		– Ambient temp.: –40 ... +80 °C	5.0	★ 1449602	NEBM-SM12G8-E-5-Q5-LE6
			7.0	★ 1449603	NEBM-SM12G8-E-7-Q5-LE6
	10.0	★ 1449604	NEBM-SM12G8-E-10-Q5-LE6		
	25/-40	Angled plug			
		– Min. bending radius: 62 mm	1.5	★ 1450736	NEBM-S1W9-E-1.5-Q5-LE6
		– Suitable for use with energy chains	2.5	★ 1450737	NEBM-S1W9-E-2.5-Q5-LE6
		– Ambient temp.: –40 ... +80 °C	5.0	★ 1450738	NEBM-S1W9-E-5-Q5-LE6
			7.0	★ 1450739	NEBM-S1W9-E-7-Q5-LE6
	10.0	★ 1450740	NEBM-S1W9-E-10-Q5-LE6		
	25/-40	Straight plug			
		– Min. bending radius: 62 mm	1.5	★ 1450368	NEBM-S1G9-E-1.5-Q5-LE6
		– Suitable for use with energy chains	2.5	★ 1450369	NEBM-S1G9-E-2.5-Q5-LE6
		– Ambient temp.: –40 ... +80 °C	5.0	★ 1450370	NEBM-S1G9-E-5-Q5-LE6
			7.0	★ 1450371	NEBM-S1G9-E-7-Q5-LE6
	10.0	★ 1450372	NEBM-S1G9-E-10-Q5-LE6		
Encoder cable					
	16/-25/-40	Straight plug			
		– Min. bending radius: 68 mm	1.5	★ 1451586	NEBM-M12G8-E-1.5-LE8
		– Suitable for use with energy chains	2.5	★ 1451587	NEBM-M12G8-E-2.5-LE8
		– Ambient temp.: –40 ... +80 °C	5.0	★ 1451588	NEBM-M12G8-E-5-LE8
			7.0	★ 1451589	NEBM-M12G8-E-7-LE8
	10.0	★ 1451590	NEBM-M12G8-E-10-LE8		
	25/-40	Angled plug			
		– Min. bending radius: 68 mm	1.5	★ 1451674	NEBM-M12W8-E-1.5-LE8
		– Suitable for use with energy chains	2.5	★ 1451675	NEBM-M12W8-E-2.5-LE8
		– Ambient temp.: –40 ... +80 °C	5.0	★ 1451676	NEBM-M12W8-E-5-LE8
			7.0	★ 1451677	NEBM-M12W8-E-7-LE8
	10.0	★ 1451678	NEBM-M12W8-E-10-LE8		

1) Other cable lengths on request.

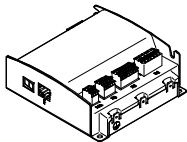
Ordering data – Motor controller			Technical data → Internet: cmmo	
	Description	Part No.	Type	
	With I/O interface			
	Switching input/output PNP	★ 1512316	CMMO-ST-C5-1-DIOP	
	Switching input/output NPN	★ 1512317	CMMO-ST-C5-1-DION	
	With IO-Link			
	Switching input/output PNP	★ 1512320	CMMO-ST-C5-1-LKP	

Festo core product range

- ★ Ready for dispatch from the Festo factory in 24 hours
- ☆ Ready for dispatch in 5 days maximum from stock