

Sensor boxes SRBG



Sensor boxes SRBG

Key features

FESTO

Function

SRBG sensor boxes are the compact solution when it comes to electrical feed-back signals and monitoring the position of process valves which are actuated with pneumatic quarter turn actuators. They can be mounted directly without

other accessories on quarter turn actuators with a mounting interface to VDI/VDE 3845. Direct mounting means that they require minimal space.

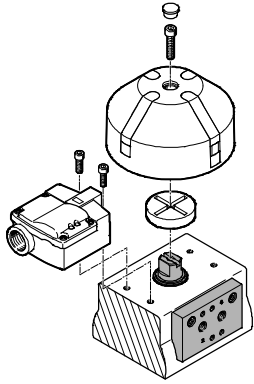

Innovative

- Direct mounting on quarter turn actuators to VDI/VDE 3845
- No adjustment is necessary when mounting the sensor
- LED on-site status display for the switching status, supply voltage and solenoid valve output
- For clockwise and anticlockwise rotating actuators with 90° and 180° rotation

Flexible

- SRBG-...-M12 with space-saving sensor connection via M12 plug connector
- SRBG-...-C2 with terminal rail connection for sensor and solenoid valve for connecting the sensor and solenoid valve to the same power supply if required
- Extensive range of switching outputs for virtually all applications
- AS-Interface versions for easy and cost-effective networking of sensors and solenoid valves
- Intrinsically safe Ex ia version for use in potentially explosive areas

Design

- Inductive double sensor
- Compact plastic housing
- PNP, NAMUR, 2-wire DC, AS-Interface switching outputs
- Direct mounting on quarter turn actuators to VDI/VDE 3845
- M12 plug connector or terminal rail connection
- LED on-site status display
- IP67
- cULus Listed, General Purpose
- Intrinsically safe Ex ia version
- SIL 2 to IEC 61508



Sensor boxes SRBG

Product range overview

Product range overview

Variant SRBG-...-M12

Variant SRBG-...-C2

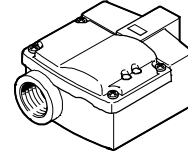
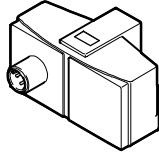

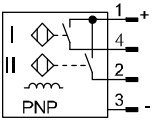
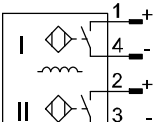
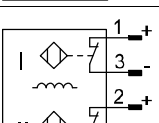
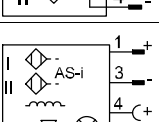
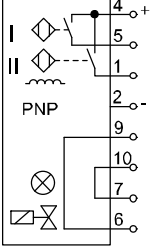
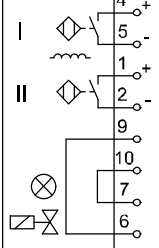
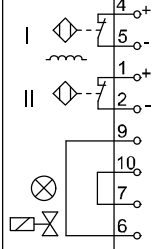
Electrical connection	Type	Operating voltage range [V]	Switching output	Switching element function	Pin allocation	→ Page
M12 plug connector	SRBG-C1-N-1-P-M12	10 ... 30	PNP	N/O contact		6
	SRBG-C1-N-1-ZU-M12	6 ... 60	Non-contacting, 2-wire	N/O contact		
	SRBG-C1-N-20N-ZC-M12-EX5	8.2	NAMUR	N/C contact		
	SRBG-C1-N-1-AS-M12-M12	26.5 ... 31.6	AS-Interface	Programmable		
Terminal rail connection	SRBG-C1-N-1-P-C2-C2	10 ... 30	PNP	N/O contact		10
	SRBG-C1-N-1-ZU-C2-C2	6 ... 60	Non-contacting, 2-wire	N/O contact		
	SRBG-C1-N-20N-ZC-C2-C2-EX5	8.2	NAMUR	N/C contact		

Sensor boxes SRBG

Peripherals overview

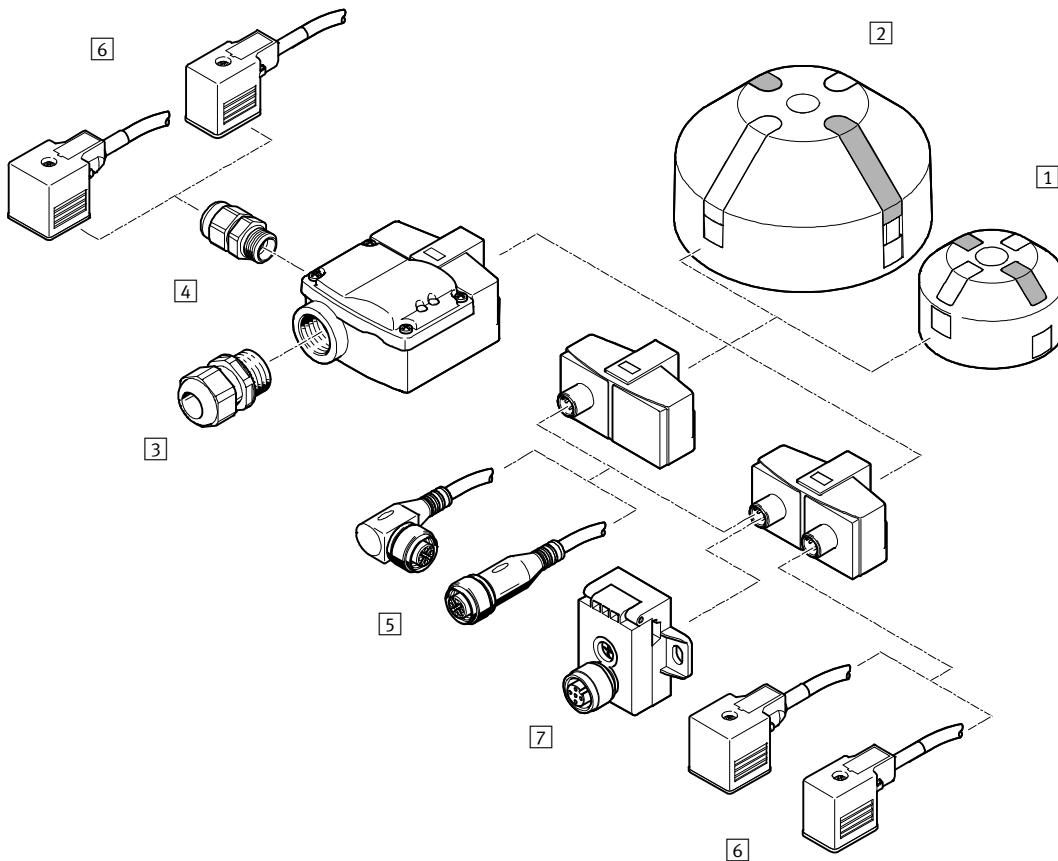

Accessory	Brief description	→ Page/Internet
1 Position indicator SASF-...-A34	<ul style="list-style-type: none"> • Position indicator with 4 actuating elements fixed at an offset of 90° • For mounting hole pattern 30 x 80 mm, shaft height 20 mm and 30 mm 	14
2 Position indicator SASF-...-A56	<ul style="list-style-type: none"> • Position indicator with 4 actuating elements fixed at an offset of 90° • For mounting hole pattern 30 x 130 mm, shaft height 30 mm and 50 mm 	14
3 Cable connector NETC-P-M20-...	<ul style="list-style-type: none"> • Polymer cable connector M20x1.5 • Black • Blue 	15
4 Cable connector NETC-P-M12-...	<ul style="list-style-type: none"> • Polymer cable connector M12x1.5 • Black • Blue 	15
5 Connecting cables NEBU-M12	Connecting cable for system connection SRBG	15
6 Connecting cables NEBV-...	Connecting cables for connecting a solenoid valve to SRBG-...-C2 or SRBG-...-M12-M12	15
7 AS-Interface components	AS-Interface components for bus connection of SRBG-C1-N-1-AS-M12-M12	16

Sensor boxes SRBG

Type codes

SRBG

SRBG – C1 – N – 20N – ZC – C2 – C2 – EX5

Type	
SRBG	Sensor box

Design	
C1	Dual sensor

Sensor principle	
N	Proximity sensor, inductive

Nominal operating voltage	
1	24 V DC
20N	8.2 V DC, NAMUR

Electrical output	
P	PNP
ZC	2-wire N/C contact
ZU	2-wire N/O contact
AS	AS-Interface

Electrical connection	
C2	Screw terminal
M12	M12 plug connector, A-coded

Electrical connection, valve	
–	Without
C2	Screw terminal
M12	M12 plug connector, A-coded

EU certification	
–	None
EX5	II1G

SASF

SASF – S2 – B – F – A34

Type	
SASF	Actuator for dual sensor

Designation	
S2	SRBG

Actuator	
B	Actuator

Switching position	
F	Fixed

Mechanical interface	
A34	Hole pattern 30 x 80 mm, shaft height 20 mm and 30 mm
A56	Hole pattern 30 x 130 mm, shaft height 30 mm and 50 mm

Sensor boxes SRBG-...-M12

Technical data

- Compact housing with M12 plug connection
- Direct mounting on quarter turn actuators to VDI/VDE 3845
- PNP, NAMUR, 2-wire DC, AS-Interface switching outputs
- AS-Interface version as A/B slave with extended addressing for up to 62 slaves
- cULus Listed, General Purpose
- Intrinsically safe version to ATEX and SIL 2 to IEC 61508



General technical data				
Type SRBG-...	-P	-ZU	-ZC	-AS
Based on standard	VDI/VDE 3845			
	EN 60947-5-2		EN 60947-5-6	EN 60947-5-2
Mounting position	Any			

Electrical data				
Type SRBG-...	-P	-ZU	-ZC	-AS
Measuring principle	Inductive			
Switching output	PNP	Non-contacting, 2-wire	NAMUR	AS-Interface
Switching element function	N/O contact		N/C contact	N/C or N/O contact, switchable
Max. switching frequency [Hz]	500		3000	100
Max. switching output voltage [V DC]	-			26.4
Operating voltage range [V DC]	10 ... 30	6 ... 60	8.2	26.5 ... 31.6
Max. output current DC [mA]	100		3	100
Max. switching capacity DC [W]	-			2.5
Voltage drop [V]	≤ 3	≤ 6	-	
Idle current [mA]	≤ 25	-		≤ 35
Residual current [mA]	0 ... 0.5	0 ... 1	-	
Minimum load current [mA]	-	4	-	
Reverse polarity protection	For all electrical connections			-
Short circuit protection	Pulsed	-	Yes	-
AS-Interface				
Protocol	-			AS-Interface
Protocol version	-			V3.0
Addressing range	-			1A ... 31A (0) 1B ... 31B
Product identification	-			IO code: D ID code: A ID1 code: 7 ID2 code: E

Sensor boxes SRBG-...-M12

Technical data

Display/operation				
Type SRBG-...	-P	-ZU	-ZC	-AS
Ready status display	Green LED	–		Green LED
Switching status indication	Yellow LED			
Status display	–			Yellow LED = valve switching status
	–			Red LED = wire break/short circuit at valve

Electromechanical components				
Type SRBG-...	-P	-ZU	-ZC	-AS
Electrical connection, input	Plug connector			
	M12x1			
	4-pin			
Electrical connection, output	–			Socket
	–			M12x1
	–			4-pin

Operating and environmental conditions				
Type SRBG-...	-P	-ZU	-ZC	-AS
Ambient temperature [°C]	–25 ... +70		–25 ... +100	–25 ... +70
Storage temperature [°C]	–25 ... +70		–40 ... +100	–25 ... +70
Degree of protection	IP67			
Shock resistance	Shock test with severity level 2 to FN 942017-5 and EN 60068-2-27			
Vibration resistance	Transport application test with severity level 2 to FN 942017-4 and EN 60068-2-6			
Degree of contamination	3			
Certification	c UL us (OL)			
	RCM compliance mark			
CE marking	To EU EMC Directive ¹⁾			
	–		To EU Explosion Protection Directive (ATEX)	–
ATEX category gas	–		II 1G	–
Type of ignition protection for gas	–		Ex ia IIC T6 GA	–
Explosion-proof temperature rating	–		–25°C ≤ Ta ≤ +100°C	–
Safety Integrity Level (SIL)	–		SIL 2	–

- 1) For information about the applicability of the component see the manufacturer's EC declaration of conformity at: www.festo.com/sp → Certificates.
If the component is subject to restrictions on usage in residential, office or commercial environments or small businesses, further measures to reduce the emitted interference may be necessary.

Materials	
Housing	PBT
Screws	High-alloy stainless steel
Note on materials	RoHS-compliant
	Contains paint-wetting impairment substances

Sensor boxes SRBG-...-M12

Technical data

Dimensions

Download CAD data → www.festo.com

SRBG-...-M12

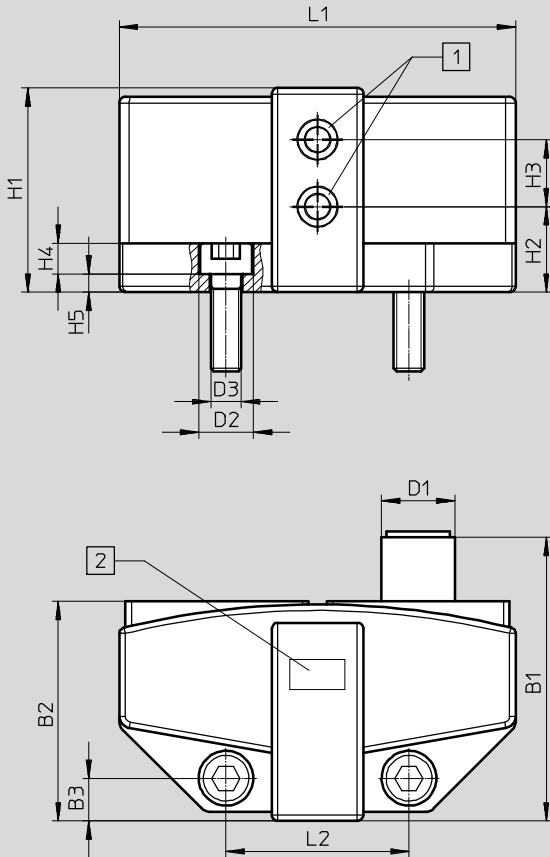

- 1 Sensor detection field I and II
- 2 LED display

Type	B1	B2	B3	D1	D2 ∅	D3 ∅
SRBG-C1-N-1-P-M12	46.5	36	7	M12x1	9	5.4
SRBG-C1-N-1-ZU-M12						
SRBG-C1-N-20N-ZC-M12-EX5						

Type	H1	H2	H3	H4	H5	L1	L2
SRBG-C1-N-1-P-M12	33.5	14	11	5	3	65	30
SRBG-C1-N-1-ZU-M12							
SRBG-C1-N-20N-ZC-M12-EX5							

Sensor boxes SRBG-...-M12

Technical data

Dimensions

Download CAD data → www.festo.com

SRBG-...-M12-M12

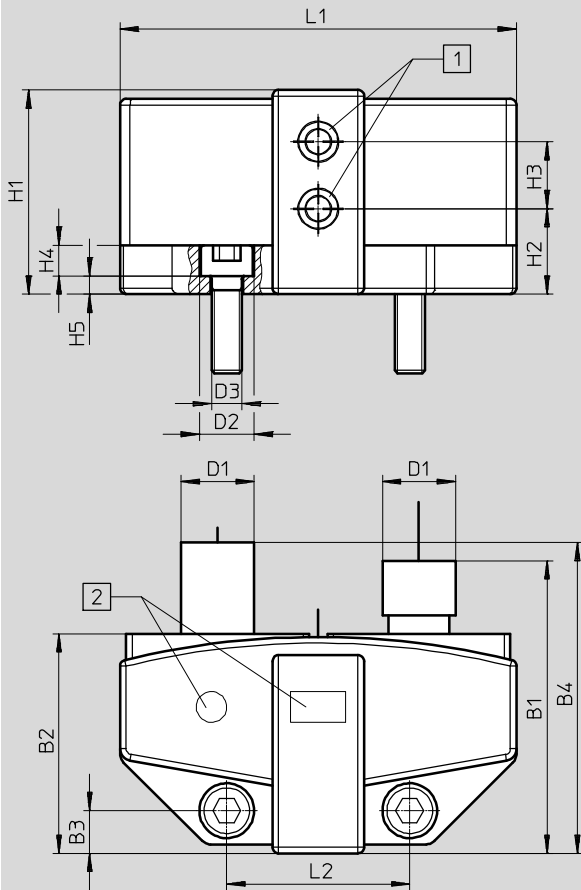

- 1 Sensor detection field I and II
- 2 LED display

Type	B1	B2	B3	B4	D1	D2	D3
SRBG-C1-N-1-AS-M12-M12	48	36	7	51	M12x1	∅ 9	∅ 5.4

Type	H1	H2	H3	H4	H5	L1	L2
SRBG-C1-N-1-AS-M12-M12	33.5	14	11	5	3	65	30

Ordering data

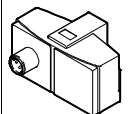
	Brief description	Dimensions [mm]	Weight [g]	Part No.	Type
	Sensor box with M12 plug connection	65 x 45, H: 35	70	3568055	SRBG-C1-N-1-P-M12
				3568056	SRBG-C1-N-1-ZU-M12
				3568057	SRBG-C1-N-20N-ZC-M12-EX5
				3567908	SRBG-C1-N-1-AS-M12-M12

Sensor boxes SRBG-...-C2

Technical data

- Compact housing with terminal rail connection for sensor and solenoid valve
- Direct mounting on quarter turn actuators to VDI/VDE 3845
- PNP, NAMUR, 2-wire DC switching outputs
- cULus Listed, General Purpose
- Intrinsically safe version to ATEX and SIL 2 to IEC 61508



General technical data			
Type SRBG-...	-P	-ZU	-ZC
Based on standard	VDI/VDE 3845		
	EN 60947-5-2		EN 60947-5-6
Mounting position	Any		

Electrical data			
Type SRBG-...	-P	-ZU	-ZC
Measuring principle	Inductive		
Switching output	PNP	Non-contacting, 2-wire	NAMUR
Switching element function	N/O contact		N/C contact
Max. switching frequency [Hz]	500		3000
Operating voltage range [V DC]	10 ... 30	6 ... 60	8.2
Max. output current DC [mA]	100		3
Voltage drop [V]	≤ 3	≤ 6	-
Idle current [mA]	≤ 25	-	
Residual current [mA]	0 ... 0.5	0 ... 1	-
Minimum load current [mA]	-	4	-
Reverse polarity protection	For all electrical connections		
Protection against short circuit	Pulsed	-	Yes

Sensor boxes SRBG-...-C2

Technical data

Display/operation			
Type SRBG-...	-P	-ZU	-ZC
Ready status display	Green LED	–	
Switching status indication	Yellow LED		
Status display	Yellow LED = valve switching status		

Electromechanical components			
Type SRBG-...	-P	-ZU	-ZC
Electrical connection, input	Spring-loaded terminal		
Electrical connection, output	Spring-loaded terminal		
Cable connector	M20x1.5		
	M12x1.5		
Connectable nominal conductor cross section [mm ²]	0.2 ... 2.5		

Operating and environmental conditions			
Type SRBG-...	-P	-ZU	-ZC
Ambient temperature [°C]	–25 ... +70		–25 ... +100
Storage temperature [°C]	–25 ... +70		–40 ... +100
Degree of protection	IP67		
Shock resistance	Shock test with severity level 2 to FN 942017-5 and EN 60068-2-27		
Vibration resistance	Transport application test with severity level 2 to FN 942017-4 and EN 60068-2-6		
Degree of contamination	3		
Certification	c UL us (OL)		
	RCM compliance mark		
CE marking	To EU EMC Directive ¹⁾		
	–		To EU Explosion Protection Directive (ATEX)
ATEX category gas	–		II 1G
Explosion ignition protection type for gas	–		Ex ia IIC T6 GA
Explosion-proof temperature rating	–		–25°C ≤ Ta ≤ +86°C
Safety Integrity Level (SIL)	–		SIL 2

- 1) For information about the applicability of the component see the manufacturer's EC declaration of conformity at: www.festo.com/sp → Certificates.
If the component is subject to restrictions on usage in residential, office or commercial environments or small businesses, further measures to reduce the emitted interference may be necessary.

Materials	
Housing	PBT
Screws	High-alloy stainless steel
Note on materials	RoHS-compliant
	Contains paint-wetting impairment substances

Sensor boxes SRBG-...-C2

Technical data

Dimensions

Download CAD data → www.festo.com

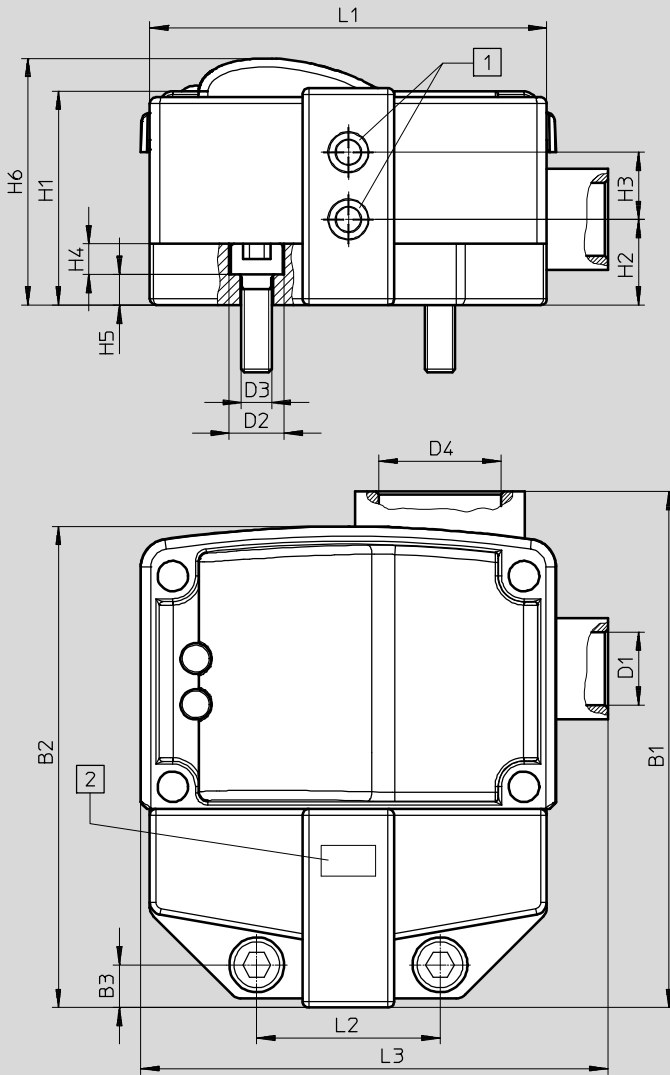

- 1 Sensor detection field I and II
- 2 LED display

Type	B1	B2	B3	D1	D2 Ø	D3 Ø	D4	H1
SRBG-C1-N-1-P-C2-C2	84.5	78.8	7	M12x1	9	5.4	M20x1.5	35
SRBG-C1-N-1-ZU-C2-C2								
SRBG-C1-N-20N-ZC-C2-C2-EX5								

Type	H2	H3	H4	H5	H6	L1	L2	L2
SRBG-C1-N-1-P-C2-C2	14	11	5	5	40	65	30	76.5
SRBG-C1-N-1-ZU-C2-C2								
SRBG-C1-N-20N-ZC-C2-C2-EX5								

Ordering data

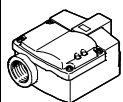
	Brief description	Dimensions [mm]	Weight [g]	Part No.	Type
	Sensor box with terminal rail connection	65 x 90, H: 40	170	3568165	SRBG-C1-N-1-P-C2-C2
				3568166	SRBG-C1-N-1-ZU-C2-C2
				3568167	SRBG-C1-N-20N-ZC-C2-C2-EX5

Sensor boxes SRBG

Accessories

Position indicator SASF for sensor boxes SRBG

- For mounting on drive shaft of standard actuators to VDI/VDE 3845
- Four fixed actuating lugs offset by 90°
- For clockwise and anticlockwise rotating actuators with 90° and 180° rotation
- Made from conductive plastic material, which prevents static discharge and is suitable for use in Ex zones
- Two position indicators suitable for all quarter turn actuator sizes



General technical data		
Type SASF-...	-A34	-A56
Type of mounting	To VDI/VDE 3845	
Adjustment range of swivel angle [deg]	0 ... 90	

Operating and environmental conditions		
Type SASF-...	-A34	-A56
Ambient temperature [°C]	-25 ... +70	
Shock resistance	Shock test with severity level 2 to FN 942017-5 and EN 60068-2-27	
Vibration resistance	Transport application test with severity level 2 to FN 942017-4 and EN 60068-2-6	

1) For information about the applicability of the component see the manufacturer's EC declaration of conformity at: www.festo.com/sp → Certificates.
If the component is subject to restrictions on usage in residential, office or commercial environments or small businesses, further measures to reduce the emitted interference may be necessary.

Materials	
Housing	PBT
	PP
	High-alloy stainless steel
Spacer	PA
Screws	High-alloy stainless steel
Note on materials	RoHS-compliant
	Contains paint-wetting impairment substances

Sensor boxes SRBG

Accessories

Dimensions

Download CAD data → www.festo.com

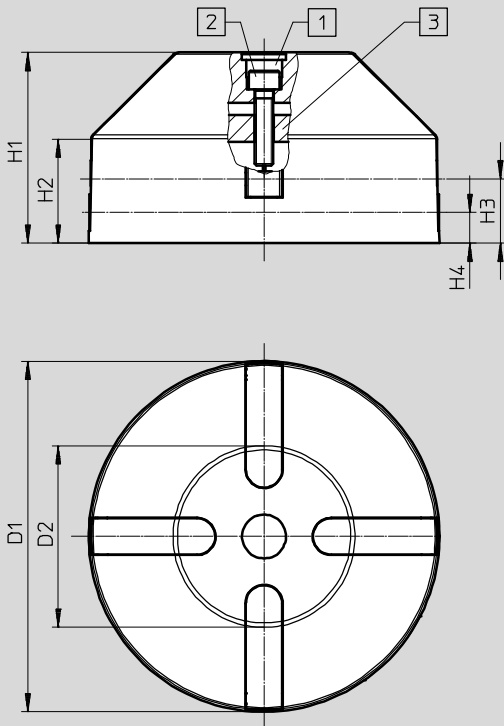

- 1 Blanking plug
- 2 Screw DIN 912 M6x25
- 3 Spacer

Type	D1 Ø	D2 Ø	H1	H2	H3	H4
SASF-S2-B-F-A34	65	41.9	38.5	26.5	18.5	7.5
SASF-S2-B-F-A56	115	59	62.5	34	21	10

Possible combinations

Function	Drives	Sizes	SASF-S2-B-F-A34	SASF-S2-B-F-A56
Double-acting	DFPD	10 ... 480	■	-
	DAPS	0008 ... 1920	■	-
	DAPS	2880 ... 8000	-	■
	DAPS-CR	0120 ... 0480	■	-
Single-acting	DFPD	20 ... 480	■	-
	DAPS	0015 ... 0960	■	-
	DAPS	1440 ... 4000	-	■
	DAPS-CR	0060 ... 0240	■	-

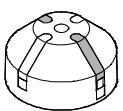

Ordering data – Position indicator

	Brief description	Dimensions [mm]	Weight [g]	Part No.	Type
	Mounting on drive shaft of standard actuators to VDI/VDE 3845	Mounting hole pattern 30 x 80 mm Shaft height 20 and 30 mm	55	4046082	SASF-S2-B-F-A34
		Mounting hole pattern 30 x 130 mm Shaft height 30 and 50 mm	140	4077125	SASF-S2-B-F-A56

Sensor boxes SRBG



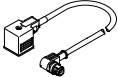
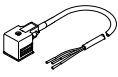

Accessories

Ordering data				
	Description	Colour	Part No.	Type
Cable connectors NETC				
	M20x1.5 made from polymer	Black	4464895	NETC-P-M20
		Blue	4197362	NETC-P-M20-EX4
	M12x1.5 made from polymer	Black	4197367	NETC-P-M12
		Blue	4197366	NETC-P-M12-EX4

Ordering data						
	Electrical connection		Cable length [m]	Protective circuit	Part No.	Type
	Left	Right				
Connecting cables NEBU						
	Straight socket, M12x1, 5-pin	Cable, open end, 4-wire	2.5	-	550326	NEBU-M12G5-K-2.5-LE4
			5		541328	NEBU-M12G5-K-5-LE4
			7		8003134	NEBU-M12G5-K-7-LE4
	Angled socket, M12x1, 5-pin	Cable, open end, 4-wire	2.5	-	550325	NEBU-M12W5-K-2.5-LE4
			5		541329	NEBU-M12W5-K-5-LE4
			10		569841	NEBU-M12W5-K-10-LE4
Connecting cables NEBV for valve connection for sensor box with AS-Interface						
	Angled socket, connection pattern type A, EN 175301-803		0.3	Yes	3679771	NEBV-A1W3F-P-K-0.3-N-M12W3
				No	3579461	NEBV-A1W3-K-0.3-N-M12W3
			0.6	Yes	3679772	NEBV-A1W3F-P-K-0.6-N-M12W3
				No	3579462	NEBV-A1W3-K-0.6-N-M12W3
			0.3	Yes	3679773	NEBV-B2W3F-P-K-0.3-N-M12W3
				No	3579463	NEBV-B2W3-K-0.3-N-M12W3
0.6	Yes	3679774	NEBV-B2W3F-P-K-0.6-N-M12W3			
	No	3579464	NEBV-B2W3-K-0.6-N-M12W3			
Connecting cables NEBV for valve connection for sensor box with terminal rail connection						
	Angled socket, connection pattern type A, EN 175301-803		0.6	Yes	3679776	NEBV-A1W3F-P-K-0.6-N-LE3
				No	3579466	NEBV-A1W3-K-0.6-N-LE3
	Angled socket, connection pattern type B, to industry standard 11 mm		0.6	Yes	3679778	NEBV-B2W3F-P-K-0.6-N-LE3
				No	3579468	NEBV-B2W3-K-0.6-N-LE3

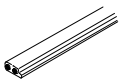
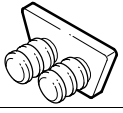
Sensor boxes SRBG

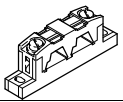
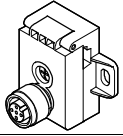
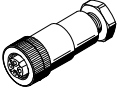
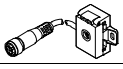
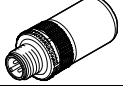
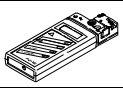
Accessories

Ordering data			
	Description	Part No.	Type
AS-Interface components			
	Flat cable for AS-Interface components, yellow, cable length 100 m	18940	KASI-1,5-Y-100
	Flat cable for AS-Interface components, black, cable length 100 m	18941	KASI-1,5-Z-100
	Cable cap for flat cable (pack of 50)	18787	ASI-KK-FK
	Cable sleeve (pack of 20)	165593	ASI-KT-FK
	Cable distributor for flat cables, rotatable cables	18786	ASI-KVT-FK
	Cable distributor for flat cables, symmetrical cables	18797	ASI-KVT-FK-S
	AS-Interface data to socket M12, 4-pin	572225	NEFU-X22F-M12G4
	Straight socket, 4-pin, screw terminal for connecting AS-Interface stations to the AS-Interface bus system	18789	ASI-SD-PG-M12
	AS-Interface data and load voltage supply to socket M12, 4-pin, cable length 1 m	572227	NEFU-X24F-1-M12G4
	AS-Interface module as bus termination	567035	CACF-BT-AS
Miscellaneous			
	Addressing device for AS-Interface stations	18959	ASI-PRG-ADR
	Addressing cable for addressing device	18960	KASI-ADR
	Primary switched mode, modular power supply, 24 V DC power supply 5 A, 10 A	2247681	CACN-3A-1-5
		2247682	CACN-3A-1-10