

## Solenoid valves VZWF, force pilot operated

**FESTO**



Festo core product range  
Covers 80% of your automation tasks

Worldwide:  
Superb:  
Easy:

Always in stock  
Festo quality at an attractive price  
Reduces procurement and storing complexity

★ Ready for dispatch from the Festo factory in 24 hours  
Held in stock in 13 service centres worldwide  
More than 2200 products

★ Ready for dispatch in 5 days maximum from stock  
Assembled for you in 4 service centres worldwide  
Up to  $6 \times 10^{12}$  variants per product series

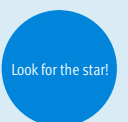

# Solenoid valves VZWF, force pilot operated

Key features and overview





## Function

Normally closed solenoid valve with diaphragm and forced lifting. When the solenoid is energised, the differential pressure from the secondary side of the diaphragm is reduced via the servo hole. The effective differential pressure lifts

the diaphragm away from the valve seat. If there is no differential pressure, the diaphragm is lifted directly by the solenoid. The valve opens and closes without a differential pressure between the inlet and outlet.

## General

-  - Connecting thread  
G1/4 ... G2
-  - Flow rate Kv  
1.8 ... 28 m<sup>3</sup>/h

## Application

- Suitable for closed applications such as cooling or filling systems
- Vacuum
- Liquid gas
- Bottling systems

## Design

- Diaphragm valves
- Forced lifting of the valve diaphragm
- 2/2-way valve, normally closed

## Advantages

- Choice of sealing materials for different fields of applications
- Medium pressure 0 bar or higher

-  - Note

The valves are suitable for vacuum with Pabs > 100 mbar. Please ensure the direction of flow corresponds to the direction of the arrow.

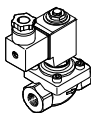
Version	Type	Process valve connection	Nominal size (DN)	Process valve nominal pressure (PN)	→ Page/Internet
	VZWF-...	G1/4	13.5	40	4
		G3/8	13.5		
		G1/2	13.5		
		G3/4	27.5		
		G1	27.5		
	VZWF-...	G1 1/4	40	40	8
		G1 1/2	40		
		G2	50		

# Solenoid valves VZWF, force pilot operated

Type codes

VZWF - B - L - M22C - G14 - 135 - V - 2AP4 - 10 - R1

**Type**

VZWF	Solenoid valve, force pilot operated
------	--------------------------------------

**Product version**

-	Standard
B	Optimised function

**Type of directional control valve**

L	In-line valve
---	---------------

**Valve function**

M22C	2/2-way valve, normally closed
------	--------------------------------

**Process valve connection**

G14	Thread G1/4
G38	Thread G3/8
G12	Thread G1/2
G34	Thread G3/4
G1	Thread G1
G114	Thread G1 1/4
G112	Thread G1 1/2
G2	Thread G2

**Nominal size (DN)**

135	13.5 mm
275	27.5 mm
400	40 mm
500	50 mm

**Sealing material**

-	Standard (NBR)
E	EPDM
V	FPM

**Nominal operating voltage**

1	24 V DC
2A	110 V AC/50-60 Hz
3A	230 V AC/50-60 Hz

**Electrical connection**

P4	Plug socket, 3-pin
----	--------------------

**Medium pressure**

6	Max. 6 bar
10	Max. 10 bar

**Corrosion protection**

-	Standard (brass)
R1	Stainless steel

# Solenoid valves VZWF, force pilot operated

Technical data – Connecting thread G1/4 ... G1

FESTO

Function

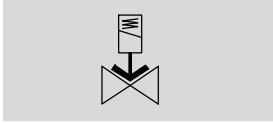

-  - Flow rate Kv  
1.8 ... 11 m<sup>3</sup>/h

-  - Connecting thread  
G1/4 ... G1



General technical data					
Process valve connection	G1/4	G3/8	G1/2	G3/4	G1
Nominal size (DN)	13.5	13.5	13.5	27.5	27.5
Valve function	2/2-way, single solenoid, closed				
Design	Diaphragm valve, force pilot operated				
Type of mounting	In-line installation				
Actuation type	Electric				
Manual override	None				
Mounting position	Solenoid vertical				
Sealing principle	Soft				
Direction of flow	Non-reversible				
Max. viscosity [mm <sup>2</sup> /s]	22				
Protection class	IP 65				
Product weight [g]	1000			1500	

# Solenoid valves VZWF, force pilot operated

Technical data – Connecting thread G1/4 ... G1

Operating and environmental conditions						
Process valve connection		G1/4	G3/8	G1/2	G3/4	G1
Switching time on	[ms]	130			275	
Switching time off	[ms]	180			290	
Standard nominal flow rate	[l/min]	1920	2350	2660	8020	11750
Flow rate	[m <sup>3</sup> /h]	1.8	2.2	2.5	7.5	11
Process valve nominal pressure (PN)		40				
Differential pressure	[bar]	0				
Medium pressure <sup>2)</sup>	[bar]	0 ... 10			0 ... 6	
Medium		Compressed air in accordance with ISO 8573-1:2010 [7:--:--]				
		Inert gases				
		Mineral oil				
		Water				
		Neutral liquids				
		Further media upon request				
Ambient temperature	[°C]	-10 ... +35 °C				
Temperature of medium	[°C]	-10 ... +80 °C				
Leak rate to EN 12266-1		A				
Corrosion resistance class CRC <sup>1)</sup> Stainless steel		3				

1) Corrosion resistance class CRC 3 to Festo standard FN 940070

High corrosion stress. Outdoor exposure under moderate corrosive conditions. External visible parts with primarily functional requirements for the surface and which are in direct contact with a normal industrial environment.

2) The valves are suitable for vacuum with Pabs > 100 mbar. Please ensure the direction of flow corresponds to the direction of the arrow.

Materials		
Solenoid valves		Material number
Housing	Brass casting	CW617N
	Stainless steel casting	1.4581
Screws	High-alloy stainless steel	1.4301
Seals	NBR	-
	FPM	-
	EPDM	-
Note on materials	Contains PWIS (paint-wetting impairment substances)	
	RoHS-compliant	

Electrical data				
		VZWF- ... 1	VZWF- ... 2A	VZWF- ... 3A
Electrical connection		Plug to EN 175301-803 type A, square design		
CE mark as per EU Pressure Equipment Directive		-	Yes	Yes
Coil characteristics				
Direct current DC	[V]	24	-	-
Alternating current AC	[V]	-	110	230
	[W]	11	-	-
Switching power	[VA]	-	19	18
Holding power	[VA]	-	16	15
	[Hz]	-	50, 60	50, 60
Permissible voltage fluctuations	[%]	±10		

# Solenoid valves VZWF, force pilot operated

Technical data – Connecting thread G1/4 ... G1

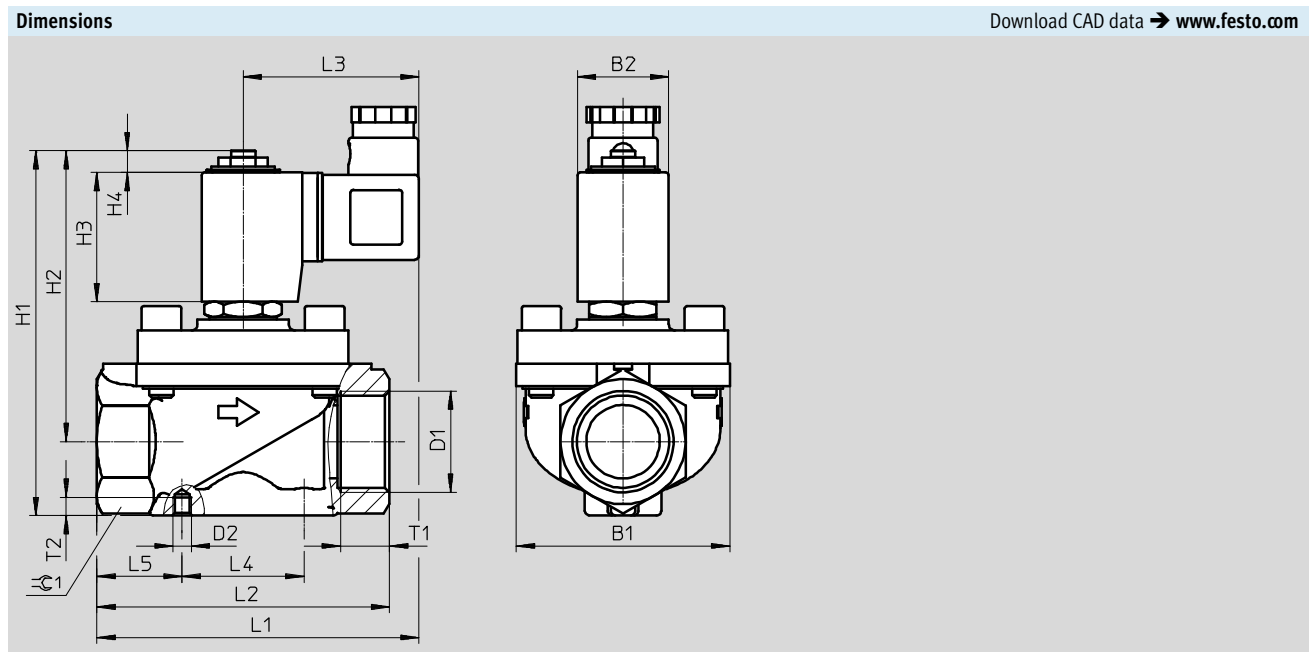

	B1	B2	D1	D2	H1	H2	H3	H4	L1	L2	L3	L4	L5	T1	T2	☞
VZWF-B-L-M22C-G14-135-...	48	30	G1/4	M4	101	86	42	7	92	67	58	25	21	12	4	27
VZWF-B-L-M22C-G14-135-...-R1	44	30	G1/4	M4	101	86	42	7	94	67	58	25	21	12	4	27
VZWF-B-L-M22C-G38-135-...	48	30	G3/8	M4	101	86	42	7	92	67	58	25	21	12	4	27
VZWF-B-L-M22C-G38-135-...-R1	44	30	G3/8	M4	101	86	42	7	94	67	58	25	21	12	4	27
VZWF-B-L-M22C-G12-135-...	48	30	G1/2	M4	101	86	42	7	92	67	58	25	21	12	4	27
VZWF-B-L-M22C-G12-135-...-R1	44	30	G1/2	M4	101	86	42	7	94	67	58	25	21	12	4	27
VZWF-B-L-M22C-G34-275-...	70	30	G3/4	M6	120	96	42	7	106	96	58	40	28	16	6	41
VZWF-B-L-M22C-G1-275-...	70	30	G1	M6	120	96	42	7	106	96	58	40	28	16	6	41

## ★ Core product range

Ordering data – Solenoid valve VZWF		Brass housing	
	Process valve connection	Part No.	Type
	G1/4	★ 1492110	VZWF-B-L-M22C-G14-135-1P4-10
	G3/8	★ 1492111	VZWF-B-L-M22C-G38-135-1P4-10
	G1/2	★ 1492112	VZWF-B-L-M22C-G12-135-1P4-10
	G3/4	★ 1492113	VZWF-B-L-M22C-G34-275-1P4-6
	G1	★ 1492114	VZWF-B-L-M22C-G1-275-1P4-6

Festo core product range

- ★ Ready for dispatch from the Festo factory in 24 hours
- ☆ Ready for dispatch in 5 days maximum from stock

# Solenoid valves VZWF, force pilot operated

Technical data – Connecting thread G1/4 ... G1

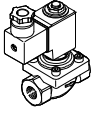
Ordering data – Solenoid valve VZWF						
	Process valve connection	Brass housing		Stainless steel casting housing		
		Part No.	Type	Part No.	Type	
	G1/4	1492126	VZWF-B-L-M22C-G14-135-E-1P4-10	1492118	VZWF-B-L-M22C-G14-135-1P4-10-R1	
		1492142	VZWF-B-L-M22C-G14-135-V-1P4-10	1492134	VZWF-B-L-M22C-G14-135-E-1P4-10-R1	
		1492206	VZWF-B-L-M22C-G14-135-2AP4-10	1492150	VZWF-B-L-M22C-G14-135-V-1P4-10-R1	
		1492222	VZWF-B-L-M22C-G14-135-E-2AP4-10	1492214	VZWF-B-L-M22C-G14-135-2AP4-10-R1	
		1492238	VZWF-B-L-M22C-G14-135-V-2AP4-10	1492230	VZWF-B-L-M22C-G14-135-E-2AP4-10-R1	
		1492302	VZWF-B-L-M22C-G14-135-3AP4-10	1492246	VZWF-B-L-M22C-G14-135-V-2AP4-10-R1	
		1492318	VZWF-B-L-M22C-G14-135-E-3AP4-10	1492310	VZWF-B-L-M22C-G14-135-3AP4-10-R1	
		1492334	VZWF-B-L-M22C-G14-135-V-3AP4-10	1492326	VZWF-B-L-M22C-G14-135-E-3AP4-10-R1	
					1492342	VZWF-B-L-M22C-G14-135-V-3AP4-10-R1
		G3/8	1492127	VZWF-B-L-M22C-G38-135-E-1P4-10	1492119	VZWF-B-L-M22C-G38-135-1P4-10-R1
			1492143	VZWF-B-L-M22C-G38-135-V-1P4-10	1492135	VZWF-B-L-M22C-G38-135-E-1P4-10-R1
			1492207	VZWF-B-L-M22C-G38-135-2AP4-10	1492151	VZWF-B-L-M22C-G38-135-V-1P4-10-R1
			1492223	VZWF-B-L-M22C-G38-135-E-2AP4-10	1492215	VZWF-B-L-M22C-G38-135-2AP4-10-R1
			1492239	VZWF-B-L-M22C-G38-135-V-2AP4-10	1492231	VZWF-B-L-M22C-G38-135-E-2AP4-10-R1
			1492303	VZWF-B-L-M22C-G38-135-3AP4-10	1492247	VZWF-B-L-M22C-G38-135-V-2AP4-10-R1
			1492319	VZWF-B-L-M22C-G38-135-E-3AP4-10	1492311	VZWF-B-L-M22C-G38-135-3AP4-10-R1
			1492335	VZWF-B-L-M22C-G38-135-V-3AP4-10	1492327	VZWF-B-L-M22C-G38-135-E-3AP4-10-R1
					1492343	VZWF-B-L-M22C-G38-135-V-3AP4-10-R1
		G1/2	1492128	VZWF-B-L-M22C-G12-135-E-1P4-10	1492120	VZWF-B-L-M22C-G12-135-1P4-10-R1
			1492144	VZWF-B-L-M22C-G12-135-V-1P4-10	1492136	VZWF-B-L-M22C-G12-135-E-1P4-10-R1
			1492208	VZWF-B-L-M22C-G12-135-2AP4-10	1492152	VZWF-B-L-M22C-G12-135-V-1P4-10-R1
			1492224	VZWF-B-L-M22C-G12-135-E-2AP4-10	1492216	VZWF-B-L-M22C-G12-135-2AP4-10-R1
			1492240	VZWF-B-L-M22C-G12-135-V-2AP4-10	1492232	VZWF-B-L-M22C-G12-135-E-2AP4-10-R1
			1492304	VZWF-B-L-M22C-G12-135-3AP4-10	1492248	VZWF-B-L-M22C-G12-135-V-2AP4-10-R1
			1492320	VZWF-B-L-M22C-G12-135-E-3AP4-10	1492312	VZWF-B-L-M22C-G12-135-3AP4-10-R1
			1492336	VZWF-B-L-M22C-G12-135-V-3AP4-10	1492328	VZWF-B-L-M22C-G12-135-E-3AP4-10-R1
					1492344	VZWF-B-L-M22C-G12-135-V-3AP4-10-R1
		G3/4	1492129	VZWF-B-L-M22C-G34-275-E-1P4-6	1492121	VZWF-B-L-M22C-G34-275-1P4-6-R1
			1492145	VZWF-B-L-M22C-G34-275-V-1P4-6	1492137	VZWF-B-L-M22C-G34-275-E-1P4-6-R1
			1492209	VZWF-B-L-M22C-G34-275-2AP4-6	1492153	VZWF-B-L-M22C-G34-275-V-1P4-6-R1
			1492225	VZWF-B-L-M22C-G34-275-E-2AP4-6	1492217	VZWF-B-L-M22C-G34-275-2AP4-6-R1
			1492241	VZWF-B-L-M22C-G34-275-V-2AP4-6	1492233	VZWF-B-L-M22C-G34-275-E-2AP4-6-R1
			1492305	VZWF-B-L-M22C-G34-275-3AP4-6	1492249	VZWF-B-L-M22C-G34-275-V-2AP4-6-R1
			1492321	VZWF-B-L-M22C-G34-275-E-3AP4-6	1492313	VZWF-B-L-M22C-G34-275-3AP4-6-R1
			1492337	VZWF-B-L-M22C-G34-275-V-3AP4-6	1492329	VZWF-B-L-M22C-G34-275-E-3AP4-6-R1
					1492345	VZWF-B-L-M22C-G34-275-V-3AP4-6-R1
	G1	1492130	VZWF-B-L-M22C-G1-275-E-1P4-6	1492122	VZWF-B-L-M22C-G1-275-1P4-6-R1	
		1492146	VZWF-B-L-M22C-G1-275-V-1P4-6	1492138	VZWF-B-L-M22C-G1-275-E-1P4-6-R1	
		1492210	VZWF-B-L-M22C-G1-275-2AP4-6	1492154	VZWF-B-L-M22C-G1-275-V-1P4-6-R1	
		1492226	VZWF-B-L-M22C-G1-275-E-2AP4-6	1492218	VZWF-B-L-M22C-G1-275-2AP4-6-R1	
		1492242	VZWF-B-L-M22C-G1-275-V-2AP4-6	1492234	VZWF-B-L-M22C-G1-275-E-2AP4-6-R1	
		1492306	VZWF-B-L-M22C-G1-275-3AP4-6	1492250	VZWF-B-L-M22C-G1-275-V-2AP4-6-R1	
		1492322	VZWF-B-L-M22C-G1-275-E-3AP4-6	1492314	VZWF-B-L-M22C-G1-275-3AP4-6-R1	
		1492338	VZWF-B-L-M22C-G1-275-V-3AP4-6	1492330	VZWF-B-L-M22C-G1-275-E-3AP4-6-R1	
				1492346	VZWF-B-L-M22C-G1-275-V-3AP4-6-R1	

# Solenoid valves VZWF, force pilot operated

FESTO

Technical data – Connecting thread G1 1/4 ... G2

Function

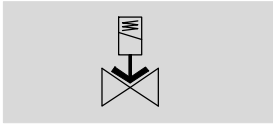

-  - Flow rate Kv  
20 ... 28 m<sup>3</sup>/h

-  - Connecting thread  
G1 1/4 ... G2



General technical data			
Process valve connection	G1 1/4	G1 1/2	G2
Nominal size (DN)	40	40	50
Valve function	2/2-way, single solenoid, closed		
Design	Diaphragm valve, force pilot operated		
Type of mounting	In-line installation		
Actuation type	Electric		
Manual override	None		
Mounting position	Solenoid vertical		
Sealing principle	Soft		
Direction of flow	Non-reversible		
Max. viscosity [mm <sup>2</sup> /s]	22		
Protection class	IP 65		
Product weight [g]	4500		6500



# Solenoid valves VZWF, force pilot operated

Technical data – Connecting thread G1 1/4 ... G2

Operating and environmental conditions				
Process valve connection		G1 1/4	G1 1/2	G2
Switching time on	[ms]	620		1220
Switching time off	[ms]	1140		2140
Standard nominal flow rate	[l/min]	21370	23500	29900
Flow rate	[m <sup>3</sup> /h]	20	22.5	28
Process valve nominal pressure (PN)		40		
Differential pressure	[bar]	0		
Medium pressure <sup>2)</sup>	[bar]	0 ... 10		0 ... 6
Medium		Compressed air in accordance with ISO 8573-1:2010 [7:-:-]		
		Inert gases		
		Mineral oil		
		Water		
		Neutral liquids		
		Further media upon request		
Ambient temperature	[°C]	-10 ... +35 °C		
Temperature of medium	[°C]	-10 ... +80 °C		
Leak rate to EN 12266-1		A		
Corrosion resistance class CRC <sup>1)</sup> Stainless steel		3		

- 1) Corrosion resistance class CRC 3 to Festo standard FN 940070  
High corrosion stress. Outdoor exposure under moderate corrosive conditions. External visible parts with primarily functional requirements for the surface and which are in direct contact with a normal industrial environment.
- 2) The valves are suitable for vacuum with Pabs > 100 mbar. Please ensure the direction of flow corresponds to the direction of the arrow.

Materials		
Solenoid valves		Material number
Housing	Brass casting	CW617N
	Stainless steel casting	1.4581
Screws	High-alloy stainless steel	1.4301
Seals	NBR	-
	FPM	-
	EPDM	-
Note on materials	Contains PWIS (paint-wetting impairment substances)	
	RoHS-compliant	

# Solenoid valves VZWF, force pilot operated

Technical data – Connecting thread G1 1/4 ... G2

Electrical data		VZWF- ... 1	VZWF- ... 2A	VZWF- ... 3A
Electrical connection		Plug to EN 175301-803 type A, square design		
CE mark as per EU Pressure Equipment Directive		-	Yes	Yes
Coil characteristics				
Direct current DC	[V]	24	-	-
Alternating current AC	[V]	-	110	230
	[W]	30	-	-
Switching power	[VA]	-	30	30
Holding power	[VA]	-	30	30
	[Hz]	-	50, 60	50, 60
Permissible voltage fluctuations	[%]	±10		

**Dimensions** Download CAD data → [www.festo.com](http://www.festo.com)

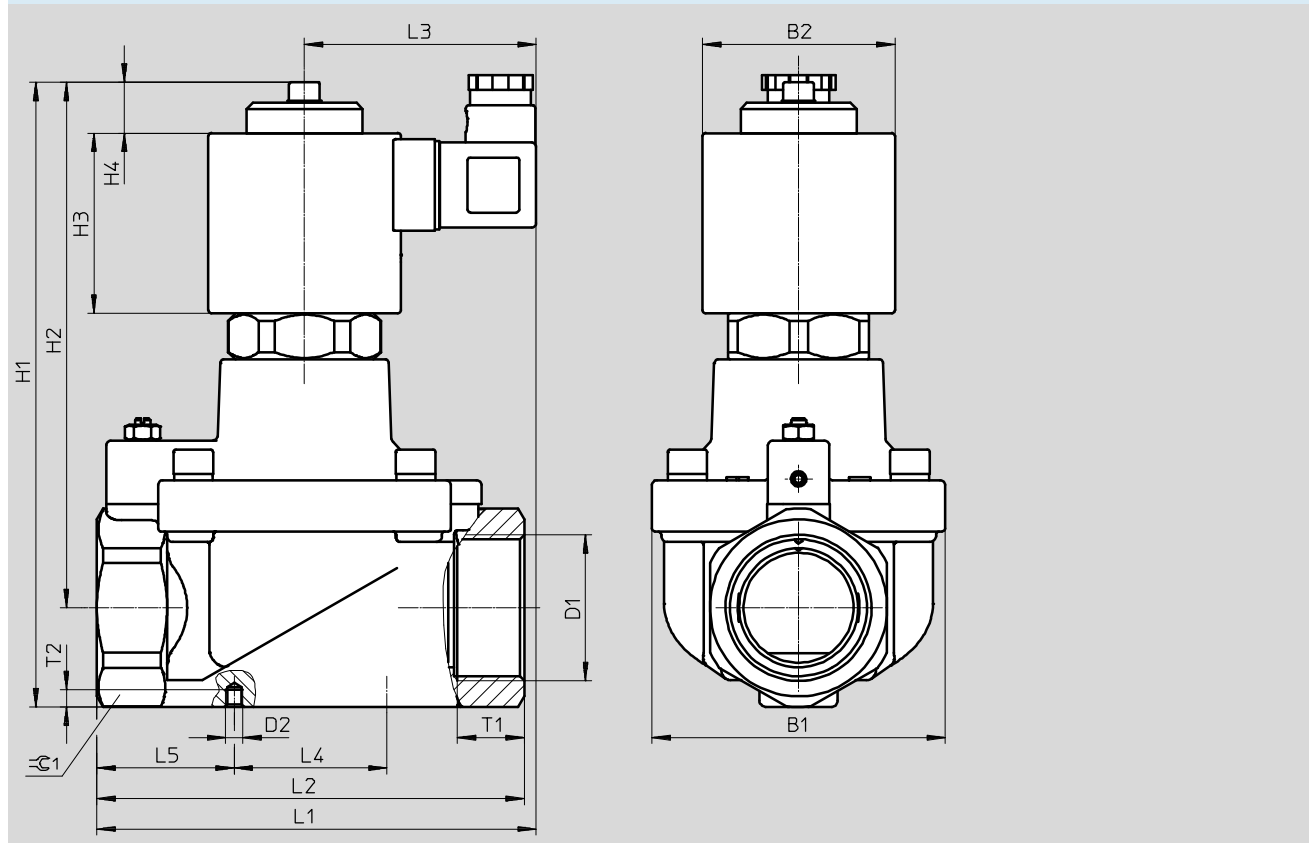

	B1	B2	D1	D2	H1	H2	H3	H4	L1	L2	L3	L4	L5	T1	T2	☞
VZWF-L-M22C-G114-400-...	96	63	G1 1/4	-	205	173	59	17	148	140	76	-	-	22	-	58
VZWF-L-M22C-G112-400-...	96	63	G1 1/2	-	205	173	59	17	148	140	76	-	-	22	-	58
VZWF-L-M22C-G2-500-...	112	63	G2	M6	218	179	59	17	159	168	76	60	55	25	6	70

# Solenoid valves VZWF, force pilot operated

Technical data – Connecting thread G1 1/4 ... G2

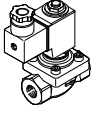
Ordering data – Solenoid valve VZWF					
	Process valve connection	Brass housing		Stainless steel casting housing	
		Part No.	Type	Part No.	Type
	G1 1/4	1492115	VZWF-L-M22C-G114-400-1P4-10	1492123	VZWF-L-M22C-G114-400-1P4-10-R1
		1492131	VZWF-L-M22C-G114-400-E-1P4-10	1492139	VZWF-L-M22C-G114-400-E-1P4-10-R1
		1492147	VZWF-L-M22C-G114-400-V-1P4-10	1492155	VZWF-L-M22C-G114-400-V-1P4-10-R1
		1492211	VZWF-L-M22C-G114-400-2AP4-10	1492219	VZWF-L-M22C-G114-400-2AP4-10-R1
		1492227	VZWF-L-M22C-G114-400-E-2AP4-10	1492235	VZWF-L-M22C-G114-400-E-2AP4-10-R1
		1492243	VZWF-L-M22C-G114-400-V-2AP4-10	1492251	VZWF-L-M22C-G114-400-V-2AP4-10-R1
		1492307	VZWF-L-M22C-G114-400-3AP4-10	1492315	VZWF-L-M22C-G114-400-3AP4-10-R1
		1492323	VZWF-L-M22C-G114-400-E-3AP4-10	1492331	VZWF-L-M22C-G114-400-E-3AP4-10-R1
		1492339	VZWF-L-M22C-G114-400-V-3AP4-10	1492347	VZWF-L-M22C-G114-400-V-3AP4-10-R1
	G1 1/4	1492116	VZWF-L-M22C-G112-400-1P4-10	1492124	VZWF-L-M22C-G112-400-1P4-10-R1
		1492132	VZWF-L-M22C-G112-400-E-1P4-10	1492140	VZWF-L-M22C-G112-400-E-1P4-10-R1
		1492148	VZWF-L-M22C-G112-400-V-1P4-10	1492156	VZWF-L-M22C-G112-400-V-1P4-10-R1
		1492212	VZWF-L-M22C-G112-400-2AP4-10	1492220	VZWF-L-M22C-G112-400-2AP4-10-R1
		1492228	VZWF-L-M22C-G112-400-E-2AP4-10	1492236	VZWF-L-M22C-G112-400-E-2AP4-10-R1
		1492244	VZWF-L-M22C-G112-400-V-2AP4-10	1492252	VZWF-L-M22C-G112-400-V-2AP4-10-R1
		1492308	VZWF-L-M22C-G112-400-3AP4-10	1492316	VZWF-L-M22C-G112-400-3AP4-10-R1
		1492324	VZWF-L-M22C-G112-400-E-3AP4-10	1492332	VZWF-L-M22C-G112-400-E-3AP4-10-R1
		1492340	VZWF-L-M22C-G112-400-V-3AP4-10	1492348	VZWF-L-M22C-G112-400-V-3AP4-10-R1
	G2	1492117	VZWF-L-M22C-G2-500-1P4-6	1492125	VZWF-L-M22C-G2-500-1P4-6-R1
		1492133	VZWF-L-M22C-G2-500-E-1P4-6	1492141	VZWF-L-M22C-G2-500-E-1P4-6-R1
		1492149	VZWF-L-M22C-G2-500-V-1P4-6	1492157	VZWF-L-M22C-G2-500-V-1P4-6-R1
		1492213	VZWF-L-M22C-G2-500-2AP4-6	1492221	VZWF-L-M22C-G2-500-2AP4-6-R1
		1492229	VZWF-L-M22C-G2-500-E-2AP4-6	1492237	VZWF-L-M22C-G2-500-E-2AP4-6-R1
		1492245	VZWF-L-M22C-G2-500-V-2AP4-6	1492253	VZWF-L-M22C-G2-500-V-2AP4-6-R1
		1492309	VZWF-L-M22C-G2-500-3AP4-6	1492317	VZWF-L-M22C-G2-500-3AP4-6-R1
		1492325	VZWF-L-M22C-G2-500-E-3AP4-6	1492333	VZWF-L-M22C-G2-500-E-3AP4-6-R1
		1492341	VZWF-L-M22C-G2-500-V-3AP4-6	1492349	VZWF-L-M22C-G2-500-V-3AP4-6-R1