

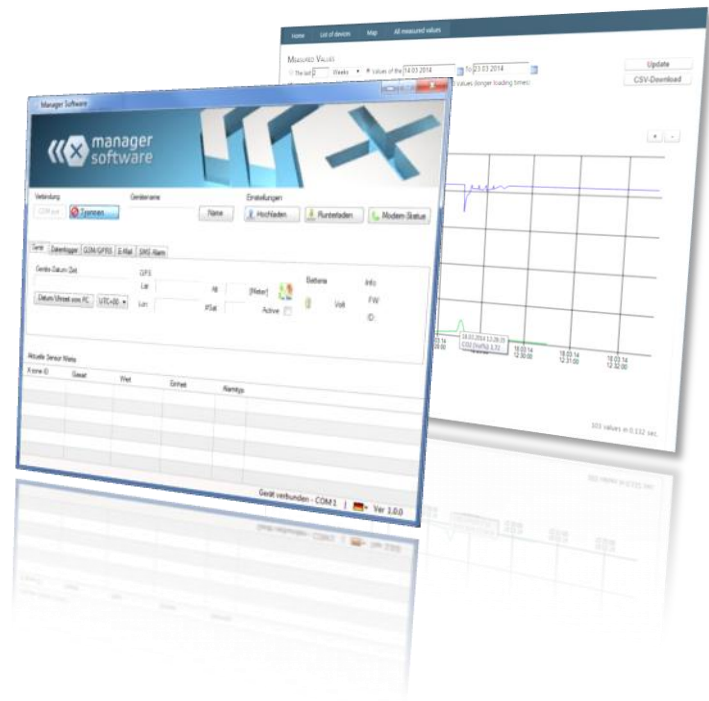

# X-zone COM



X-zone Com  II 2G Ex ib [Ia IIC Ga] [Ib IIC] IIB T3/T4 Gb  
Type: 02617

## Operating Manual

Rev20141022-01

Article number 8094130

---

## Translation

If any discrepancies are found in the translated text, you should refer to the original German language Operating Manual or contact the manufacturer.

## Copyright

Unless expressly authorized by the publisher, the reproduction, storage and transmission of this document and its contents, are prohibited. Violators are subject to penalty. All rights reserved.

## Common names

The use of common names, trade names, description of goods and suchlike in this Operating Manual does not imply that such names may be freely used; in many cases these are protected trademarks even though they are not denoted as such.

## Approval

This document is not a substitute for the Technical Documentation of the valid certifications. If required, please ask for this Technical Documentation from ORI GmbH & Co.KG.

## Use in potentially explosive atmospheres

Equipment or components that are used in potentially explosive atmospheres and which are tested and approved in accordance with national, European, or international explosion protection directives must only be used in the conditions specified in the licence and in compliance with the applicable statutory provisions. **No modifications may be made to the equipment or components. The use of defective or incomplete parts is prohibited.** Relevant provisions apply to the repair of this equipment and its components.

The equipment must be inspected and maintained by qualified specialists.



**Please read this Manual carefully before using this equipment for the first time.**

---

(Please enter X-zone Com serial number here)

# TABLE OF CONTENTS

<b>1</b>	<b>General.....</b>	<b>5</b>
1.1	Function description.....	5
1.2	Intended use.....	5
1.3	Storage, and return.....	6
1.4	Disposal.....	6
<b>2</b>	<b>Safety Information.....</b>	<b>7</b>
2.1	Safety marks and symbols.....	7
2.2	Safety information.....	8
2.3	Operating safety.....	8
<b>3</b>	<b>Design and Technical Data.....</b>	<b>9</b>
3.1	Dimensions.....	9
3.1.1	X-zone Com + X-zone 5x00.....	9
3.1.2	Charger I.S. power supply 02617PS.....	10
3.2	X-zone Com and charger interfaces.....	10
3.2.1	X-zone Com.....	10
3.2.2	Charger I.S. power supply 02617PS.....	12
3.3	Labelling.....	13
3.4	Device specifications.....	14
3.4.1	X-zone Com.....	14
3.4.2	Charger.....	15
<b>4</b>	<b>Assembly and Initial Operation.....</b>	<b>16</b>
4.1	Installing the manager software.....	16
4.1.1	System requirements.....	16
4.1.2	Installing the manager software.....	16
4.2	Initial operation.....	18
4.2.1	Charging the battery.....	18
4.2.2	Inserting the SIM card.....	19
4.2.3	Antenna installation/removal.....	21
4.2.4	Connecting the X-zone 5x00.....	22
4.3	Disconnecting from X-zone 5x00.....	24
<b>5</b>	<b>Configuring X-zone Com.....</b>	<b>25</b>
5.1	Establishing PC-connection.....	25
5.1.1	Bluetooth connection.....	25
5.1.2	Cable-based connection.....	26
5.2	Overview/Start view.....	27
5.3	Connection information.....	28
5.3.1	Connecting to X-zone Com.....	28
5.3.2	Change device designation/measuring site name.....	29
5.3.3	Saving and loading X-zone Com settings.....	30
5.3.4	Show data history.....	30

5.4	Configuring X-zone Com .....	32
5.4.1	"Device" tab .....	33
5.4.2	"Data logger" tab.....	34
5.4.3	"GSM/GPRS" tab.....	35
5.4.4	"Email" tab .....	36
5.4.5	"SMS" tab.....	38
5.4.6	"Status" tab .....	39
5.5	Measurements section.....	40
<b>6</b>	<b>X-Zone Com Controls.....</b>	<b>41</b>
6.1	Operator control panel .....	41
6.2	Turning on the device .....	41
6.3	Turning off the device .....	42
6.4	Screen displays .....	42
6.4.1	Symbol overview.....	42
6.4.2	Error display.....	43
6.5	Performing a function test.....	44
<b>7</b>	<b>Sending Text Messages to X-Zone Com.....</b>	<b>45</b>
7.1	Reader text messages commands .....	46
7.1.1	Status query.....	46
7.1.2	Inquiring about group status .....	47
7.1.3	Locally connected X-zone 5x00 readings.....	48
7.1.4	Query for a group's maximum measured values.....	49
7.1.5	Displaying GPS coordinates .....	50
7.1.6	Querying current alarms .....	51
7.2	Execute text messages commands.....	53
7.2.1	Alarm acknowledgement .....	53
7.2.2	Enabling an evacuation alarm .....	53
7.2.3	Resetting the evacuation alarm .....	54
<b>8</b>	<b>Mcloud in Brief .....</b>	<b>55</b>
8.1	Mcloud device list .....	55
8.2	Mcloud device status .....	57
8.3	Mcloud measurement values.....	58
8.4	Mcloud map plotting.....	59
<b>9</b>	<b>Maintenance and Care.....</b>	<b>61</b>
9.1	Frequency.....	61
9.2	Cleaning.....	61
9.3	Removing the battery for repair .....	61
<b>10</b>	<b>Appendix.....</b>	<b>62</b>
10.1	Error codes .....	62
10.2	Order list .....	63
10.3	Firmware updating .....	64
10.4	Certificates.....	66



# 1 GENERAL

## 1.1 FUNCTION DESCRIPTION

The localisation and communication unit **X-zone Com** is designed for use in industrial environments. It supplements the Dräger X-zone 5x00 gas detection system with Dräger X-am 5x00 (hereinafter referred to as X-zone 5x00).

When connected to an X-zone 5x00, **X-zone Com** regularly monitors X-zone 5x00 gas concentrations, and records them and any alarm events in a cache, until the system transmits the data to the ORI Mcloud Server or a user-specified e-mail address. If X-zone 5x00 is connected to other X-zone 5x00 devices (wireless or by cable), it will also transmit alarms. If the X-zone network is integrated into a network (group), **X-zone Com** will instead metre, cache, and transmit the group's gas concentration and alarm information instead of those of the X-zone 5x00.

X-zone Com can integrate position data in all X-zone 5x00 readings if GPS communication is possible.

It is also able to receive, reply to, and transmit status queries via short message service (text). In the event of an alarm, it will send both e-mails and text messages.

Users are able to configure X-zone Com either via Bluetooth or via a serial interface by means of PC software (hereinafter referred to as Manager Software).

## 1.2 INTENDED USE

X-zone Com may be operated in zone 1 and zone 2 explosive atmospheres (in accordance with  II **2G Ex ib [Ia IIC Ga] [Ib IIC] IIB T3/T4 Gb**) if it is used with the Dräger X-zone 5x00 alarm amplifier. Any other use or modification of the device without the manufacturer's written agreement shall be deemed improper use and shall void the ATEX licence and the warranty.

The manufacturer shall not be liable for damages resulting from improper or unintended use, such use being at the sole risk of the operator. The device may pose a risk if used improperly or for purposes other than the intended purpose. Please render the device inoperative immediately if you have reason to believe that safe operation is no longer possible.

Compliance with intended use also requires detailed knowledge of and adherence to the instructions in this Operating Manual.

### NOTE



*Please carefully read the separate operating instructions for Dräger X-zone 5x00 and the connected gas measuring device Dräger X-am 5x00, paying particular attention to the relevant safety precautions.*

---

## 1.3 STORAGE, AND RETURN

---

**Storage:** Disconnect any connections to the X-zone 5x00. Please observe the manufacturer's instructions for X-zone 5x00. Turn off X-zone Com and store it connected to the charger outside of the ex-protection zone indoors. If stored disconnected from the charger for more than 6 months, you will have to recharge the internal battery for at least 48 hours prior to use.

**Return:** Prior to returning the device to ORI Abwassertechnik GmbH & Co. KG, e.g. for repair, etc., proceed as follows:

- Make sure the device is clean. This is particularly important if hazardous substances, such as combustible, poisonous, corrosive or carcinogenic agents might be present.

We will charge the operator for any costs incurred as a result of insufficient cleaning of the device, including those for the disposal of hazardous waste or for personal injury (burns, etc.).

---

## 1.4 DISPOSAL

---

**Packaging:** Keep the packaging of the device in case you have to return it at a later date. If this is not desired, the wood, cardboard and PE packaging material can be disposed of through the usual channels.

**X-zone Com:** Do not dispose of this device as municipal solid waste (in accordance with Directive 2002/96/EG). Please consider and observe environmental compatibility, health risks, and local disposal regulations. Clean and disinfect the device and dispose of it at the appropriate collection point. Further information may be obtained from the competent authority. If you send your old X-zone Com to us carriage-free, we will dispose of it at no charge, if requested. Please refer to the Return section in the previous paragraph.



**Rechargeable battery:** Do not dispose of X-zone's rechargeable battery with municipal solid waste (in accordance with Directive 2006/66/EG). Dispose of the battery in compliance with statutory provisions at the local battery collection points.

## 2 SAFETY INFORMATION

### 2.1 SAFETY MARKS AND SYMBOLS

Correct and safe operation of this device is possible only if you pay close attention to the safety information in this Operating Manual. The safety information contained in this Operating Manual states the expected grades of risk designated by the following symbols and colours:

**WARNING**



*Denotes a potentially hazardous situation that may result in serious injury, death or cause a safety risk. Please observe the work instructions closely and take the appropriate precautionary measures.*

**CAUTION**





*Denotes a potentially hazardous situation that, if not handled correctly, may result in injury, improper operation, or damage to the equipment or the environment. Please observe the instructions carefully.*

**NOTE**



*General notices, information, or tips. Not used to warn of dangers.*

**Other symbols:**

Symbol	Description
	Wear protective clothing
	Consult operating instructions

---

## 2.2 SAFETY INFORMATION

---

The following safety instructions must be observed for the X-zone Com.

### CAUTION



*This device must be inspected and maintained by qualified specialists at regular intervals (see IEC 60079-1).*

### WARNING



#### **Explosion hazard**

*If the housing or any of its components should become damaged, put the device immediately out of operation and implement measures to prevent unintended or unauthorised use.*

### WARNING



#### **Explosion hazard**

*Perform repair, service, and maintenance work only in a non-explosive environment.*

### WARNING



#### **Danger: Risk of fatal injury**

*To avoid fatal injury, follow the Dräger X-zone 5x00 and Dräger X-am 5x00 Safety Instructions carefully and without exception.*

---

## 2.3 OPERATING SAFETY

---

**Repairs:** Device repairs or modifications not mentioned in the Operating Manual may be performed only by the manufacturer or a service technician authorised by the manufacturer.

**Technical improvements:** The manufacturer reserves the right to update technical data to keep pace with technological improvements without prior notice. Information about these activities and possible upgrades to this Manual are available from ORI Abwassertechnik GmbH & Co. KG.

## 3 DESIGN AND TECHNICAL DATA

The information contained in this Operating Manual applies only to the device type specified on the cover.

X-zone Com has its own internal rechargeable battery for operation in the ATEX zones (in accordance with Directive 94/9/EG). The control panels operate by means of the magnetic pen that comes with the product. The device has an integrated GSM/GPRS modem for the transmitting of alarms, status messages, and data. Data transmitted by X-zone 5x00 are stored in an internal data memory with a capacity of approximately 262,000 sets of data. The data storage is designed as a circular buffer which overwrites the oldest sets of data first.

### 3.1 DIMENSIONS

#### 3.1.1 X-zone Com + X-zone 5x00

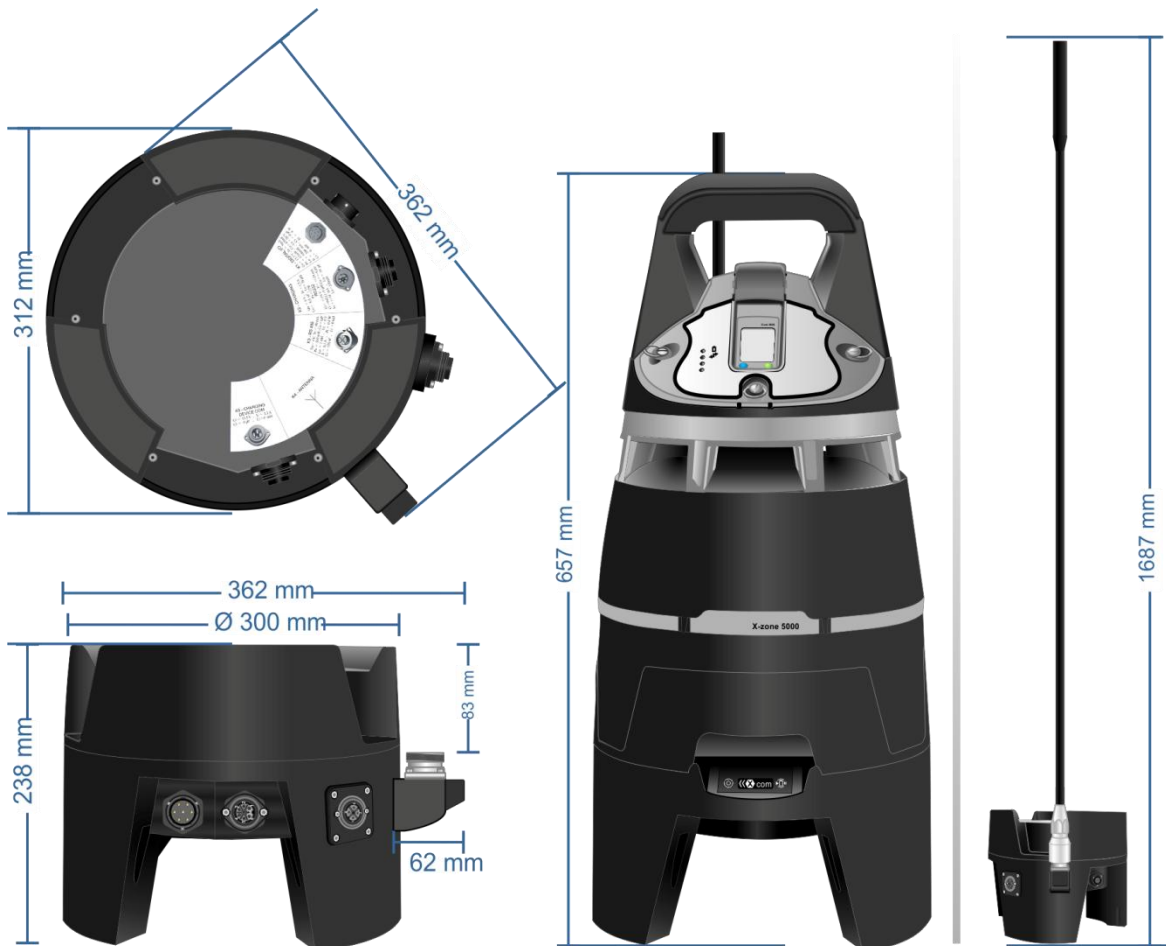

Fig. 3.1: X-zone Com dimensions and X-zone Com with X-zone 5x00.

### 3.1.2 Charger I.S. power supply 02617PS

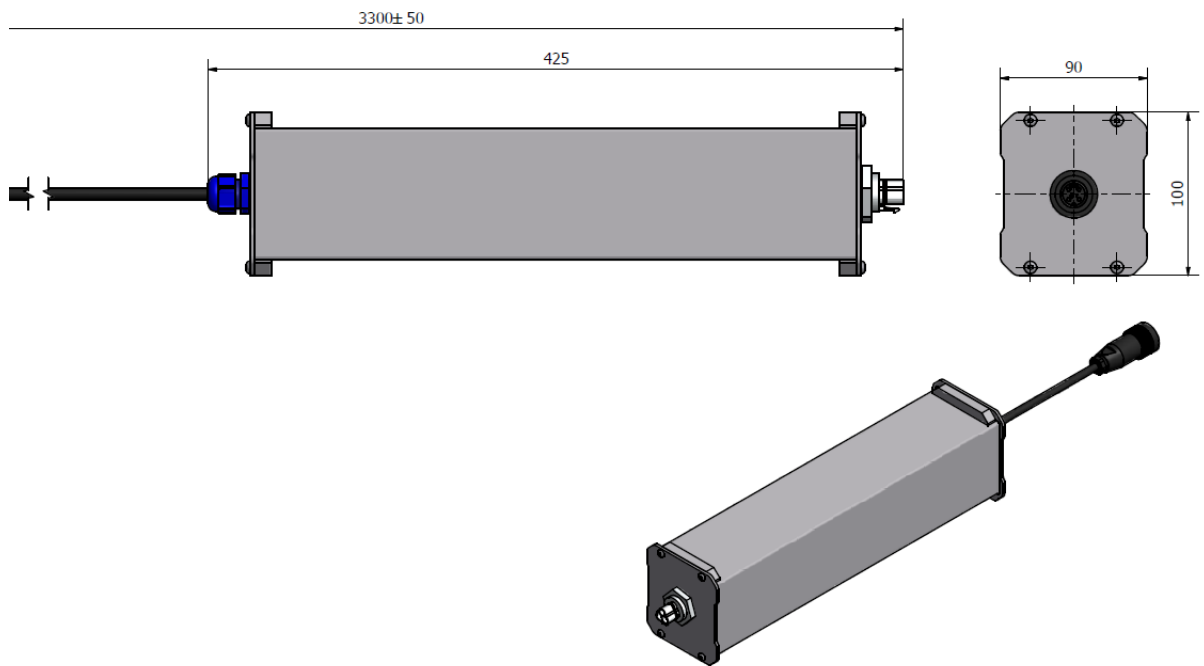

Fig. 3.2: Dimensions of charger in mm.

## 3.2 X-ZONE COM AND CHARGER INTERFACES

### 3.2.1 X-zone Com

X-zone Com has various interfaces for data transmission (K3=RS485, K2=RS232), a digital input/output (K1), charger socket (K5) and an antenna socket for the GSM/GPRS aerial (K4).

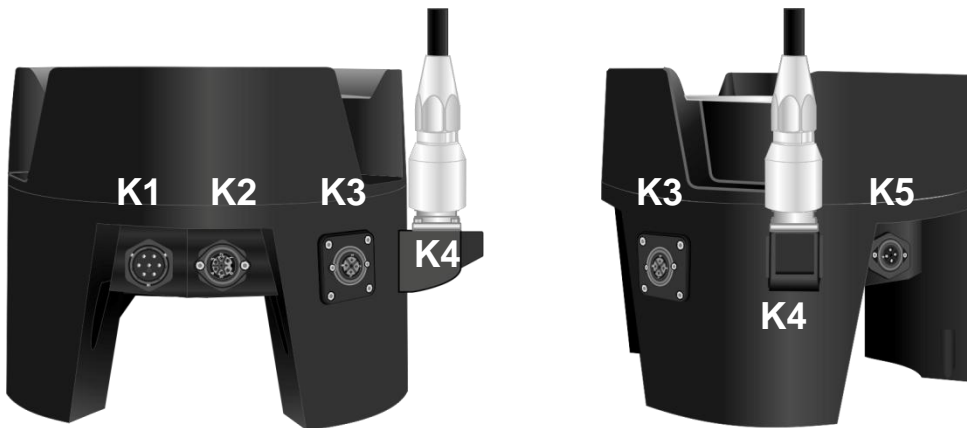







Fig. 3.3: Interface configuration on the X-zone Com.

	Function	Type	View	Configuration
<b>K1</b>	I / O Digital	7-pole plug		<ul style="list-style-type: none"> <li>3. GND</li> <li>4. Normally closed (NC)</li> <li>5. Normally open (NO)</li> <li>6. Common (COM)</li> <li>7. Input</li> </ul>
<b>K2</b>	RS232 Serial interface (DTE)	7-pole socket		<ul style="list-style-type: none"> <li>1. TxD</li> <li>2. CTS</li> <li>3. RTS</li> <li>4. Charging +</li> <li>5. Charging GND</li> <li>6. GND (RS232)</li> <li>7. RxD</li> </ul>
<b>K3</b>	RS485 X-zone 5x00 connection	3-pole+PE socket		<ul style="list-style-type: none"> <li>1. PLUS (+)</li> <li>2. MINUS (-)</li> <li>3. GND</li> </ul>
<b>K4</b>	Antenna socket	HF socket 7/16 DIN		
<b>K5</b>	Charger connec- tion X-zone Com	3-pole + PE plug		<ul style="list-style-type: none"> <li>1. Charging +</li> <li>2. Charging GND</li> </ul>
	Internal recharge- able battery	7-pole plug		<ul style="list-style-type: none"> <li>1. Communication (SCL)</li> <li>2. Communication (SDA)</li> <li>3. RESET</li> <li>4. appliance output (+)</li> <li>5. appliance GND</li> <li>6. Input external source (+)</li> <li>7. Input external source (GND)</li> </ul>

### 3.2.2 Charger I.S. power supply 02617PS

The charger power cable is available in three different versions:

With supply jack	Country / Region	ORI Order No.	Dräger Order No.
CEE 7/7	Europe	Is included in the scope of delivery	8325 391
AS3112	Australia	8094 140	8325 393
BS 1363	UK	8094 141	8325 392

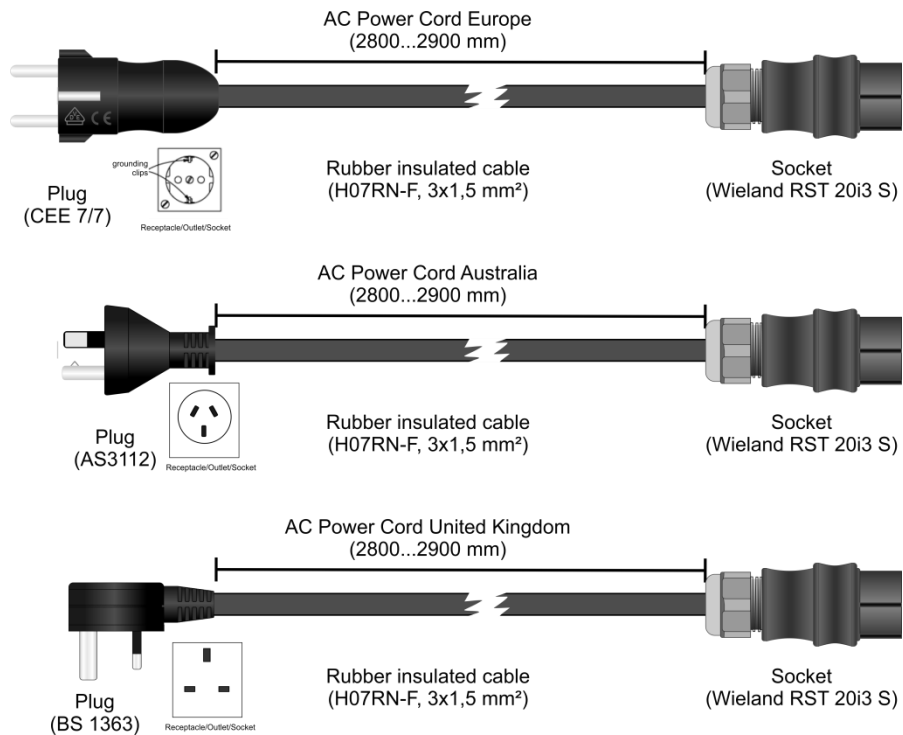
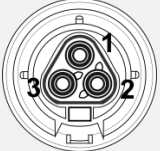



Fig. 3.4: Charger power cable (for Europe, Australia and United Kingdom).

Function	Type	View	Configuration
<b>Power cable plug</b>	CEE 7/7		
<b>Input connector</b>	Wieland RST20i3S 3-pole		1. L1 (black) 2. N (blue) 3. PE (green/yellow)
<b>Output socket</b>	Binder RD24 Series 693 - 3-pole+PE		1. PLUS (+) 2. GND 3. Normally closed (NC) 4. Normally closed (NC)



### 3.3 LABELLING

The name plate is affixed to the upper side of X-zone Com and contains the following information:

- Device designation
- Manufacturer's name and address
- CE marking
- Serial identification and type no.
- Serial number, which contains year of manufacture
- Certifying agent, year of registration/approval, registration/approval number, ingress protection rating
- Ex marking

Please quote the device designation and serial number when submitting queries or ordering spare parts.

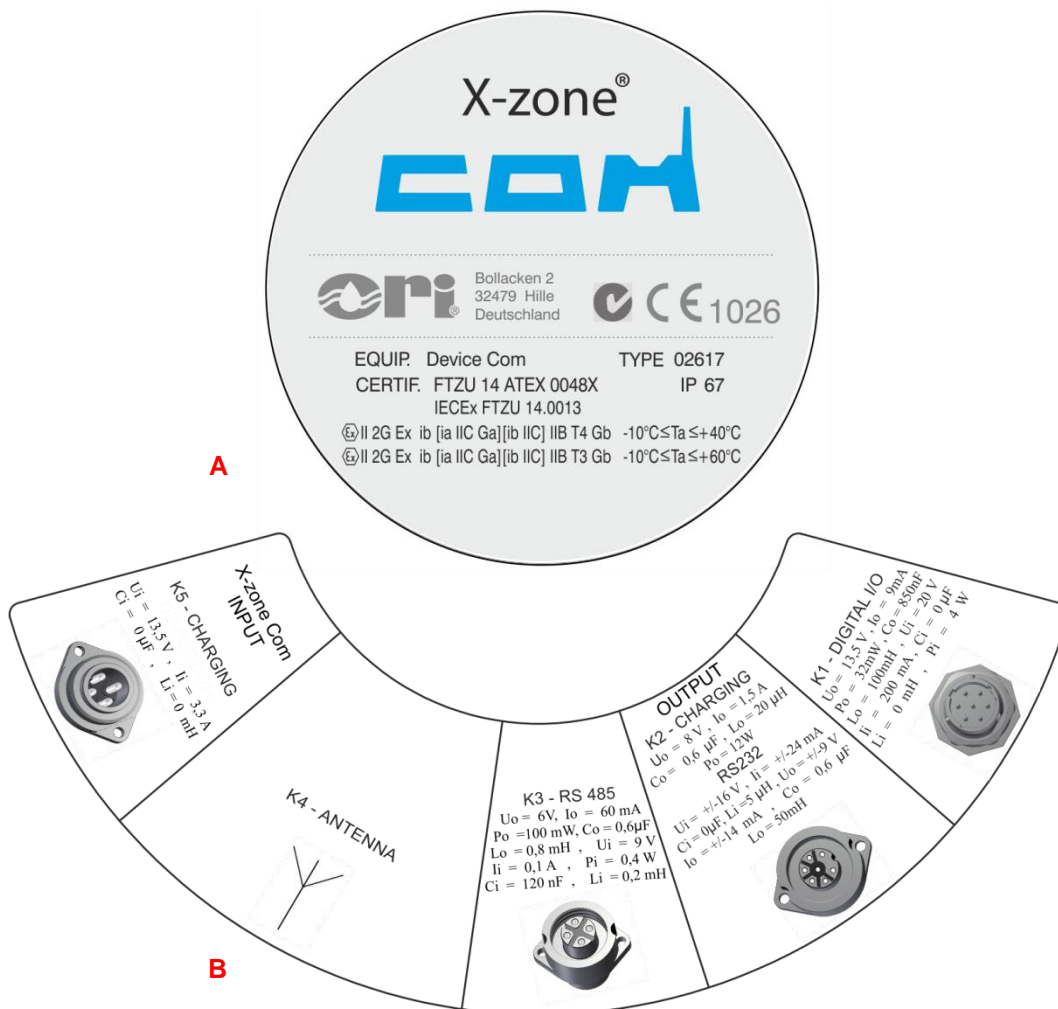

Fig. 3.5: **A)** X-zone Com name plate on the top of the housing.  
**B)** Supply information on the bottom side of the housing.

## 3.4 DEVICE SPECIFICATIONS

### 3.4.1 X-zone Com

Technical data: X-zone Com		
ATEX / IECEx marking	IECEx FTZU 14.0013X FTZU 14 ATEX 0048X	Ex ib [ia IIC Ga] [ib IIC] IIB T3/T4 Gb ⊕ II 2G Ex ib [ia IIC Ga] [ib IIC] IIB T3/T4 Gb
IP rating	<b>IP 67</b>	<i>(with closed plug connection)</i>
Dimensions (ØXH); weight	362 x 238 mm; 9,8 kg	<i>(without Dräger X-zone 5x00)</i>
Temperature range	<b>Ambient temperature</b>	-10°C .. + 60°C, temperature class T3 -10°C .. + 40°C, temperature class T4
	<b>Storage temperature</b>	-20°C .. + 60°C <i>(without battery)</i> 0°C .. +50°C <i>(battery)</i> 0°C .. + 50°C <i>(charger)</i>
	<b>Ambient temp. charging</b>	+5°C..+30°C <i>(charging time 30 hrs)</i> <i>(with automatic charge shut-off at battery temperatures below 0° C and higher than +45° C)</i>
Relative humidity	5 - 95%	
Internal memory	8 MB – approx. 262,000 datasets	
Internal battery (type NiMh)	Rated output voltage	12 V
	Max. output voltage	15 V
	Rated output current	0.92 A
	Capacity	13.5 Ah
	Rechargeable internally at	9...15 VDC / 1.5A
Wireless communication	<b>Bluetooth</b>	v3.0; class 1 <i>(internal antenna)</i> , 4dBm ERP
	<b>GSM/GPRS</b>	Type Mgsn modem Quadband 850/900/1800/1900 MHz
	<b>Antenna</b> (factory installed)	Dualband 900 /1800 MHz
Intrinsically safe physical interfaces	<b>1 x RS485 (K3)</b>	Connection Dräger X-zone 5x00
	<b>1 x RS232 (K2)</b>	RS232 + optional alien device charging
	<b>1 x DI/DO (K1)</b>	for optional Switch ON/OFF Box
	<b>1 x K5</b>	X-zone Com power unit/charger
	<b>1 x HF 7/16 DIN (K4)</b>	Antenna
GPS module	With internal antenna	
Display	OLED	
Applicable harmonised standards	ETSI EN 300 328 V1.7.1:2006; ETSI EN 301 489-1 V.1.8.1:2008 : ETSI EN 301 489-7/V1.3.1:2005; ETSI EN 301 489-17/ V2.1.1:2009; ETSI EN 301511 V9.02:2003; EN 60079-0: 2012; EN 60079-11:2012; EN 60079-26: 2007 EN 50581:2012; EN 60950-1:2006; EN 61000-6-2:2005; EN 61000-6-3:2007	
Applicable EU directive	94/9/EC - ATEX 2004/108/EC - EMC 1999/5/EC - R&TTR	

### 3.4.2 Charger

Specifications: Charger I.S. Power Supply Unit 0217PS		
IP rating Safety class	IP 65 I	⊕ II (2)G [Ex ib Gb] IIB
Dimensions (L x W x H); height		425 x 90 x 100 mm without cable 3300 ± 50 x 90 x 100 with cable 1 kg
Ambient temperature for charging		+5°C..+30°C ( <i>charging time 30 hrs</i> ) ( <i>with automatic charge shut-off at battery temperatures below 0° C and higher than +45° C</i> )
Relative humidity	≤ 90%	
Electrical	<b>Input voltage</b>	90-230 VAC; 47 - 63 Hz 135-370 VDC;
	<b>Input current</b>	1 A
	<b>Rated output voltage</b>	12 VDC (nominal)
	<b>Rated output current</b>	2 A (continuous)
Intrinsically safe specifications	<b>Uo</b>	13.5 V
	<b>Io</b>	2.8 A
	<b>Co</b>	50 nF
	<b>Lo</b>	30 μH

## 4 ASSEMBLY AND INITIAL OPERATION

Prior to using X-zone Com for the first time, it is necessary to configure it by means of PC software (ORI Manager Software). The following explains how to install the Manager Software on your PC. Subsequently, it explains the mechanical steps for the first operation of X-zone Com.

### 4.1 INSTALLATING THE MANAGER SOFTWARE

#### 4.1.1 System requirements

To install the Manager Software, your system requires:

- Microsoft Windows XP/Vista/7/8 – 32bit or 64bit operating system
- Installed Microsoft .NET Framework
- Approximately 10 MB hard disk storage (excluding .NET Framework)

#### NOTE



*Microsoft .NET Framework may be downloaded free of charge from the Microsoft Website. Please ensure you download the suitable version for your operating system (either 32 bit or 64 bit). If you experience difficulties, please contact your IT specialist.*

#### 4.1.2 Installing the manager software

Insert the CD; the installation process will start automatically. If the installation does not start by itself please open "setup.exe" or "manager\_setup.msi" on the CD and follow the instructions.

#### NOTE



*This computer program is protected by copyright law and international agreements. Unauthorised duplication or distribution is prohibited.*

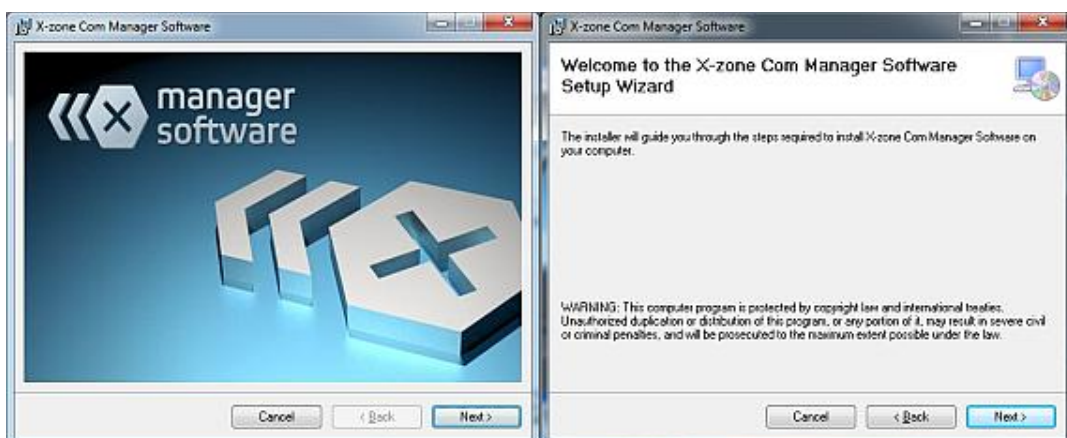

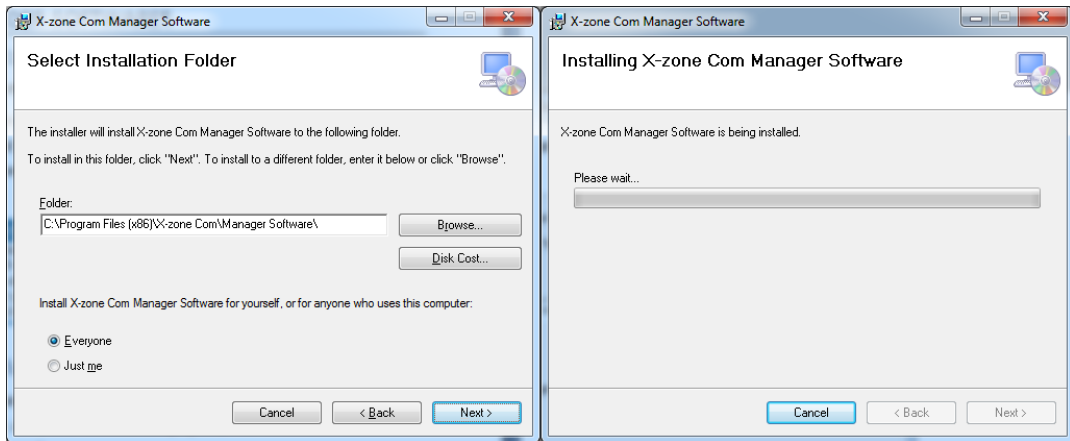

Fig. 4.1: Manager Software installation assistant.

The Manager Software will usually install in the following directory:

`c:\Program Files (x86)\X-zone Com\Manager Software\`

To select another directory, click [Browse...] or enter the storage path in the textbox below "Folder:".

If you select [Everyone], the software will install to allow access for all users of the PC.

If you select [Just me], the software will install to allow access for the logged-in user only.

To install the program in this directory, click [Next>]. A desktop link to the programme will install automatically.

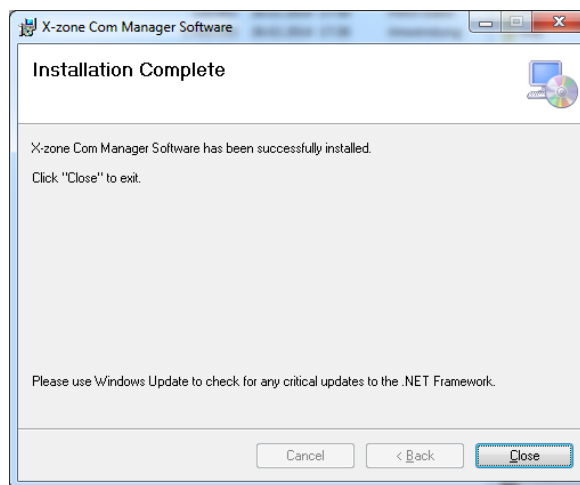

Fig. 4.2: Successful installation.

When the installation is completed, click [Close] to close the installation assistant.

## 4.2 INITIAL OPERATION



Allow only qualified persons to assemble, wire, connect, start X-zone Com for the first time, operate it and perform maintenance. Qualified persons must have read and understood the Operating Manual and must wear suitable protective clothing while installing, operating, maintaining, and transporting the device. Before switching on the system, check that all connections are correct.

### 4.2.1 Charging the battery

When you charge X-zone Com, make sure the power supply unit/charger (hereinafter referred to as power supply unit) and the mains outlet are outside the potentially explosive atmosphere and outside the established ex zone. In addition, before you connect the power supply unit to the mains, make sure the voltage stated on its nameplate matches that of the mains. Once you have done this, you may connect the power supply unit to X-zone Com's K5 connector (see Chapter 4.2.4).

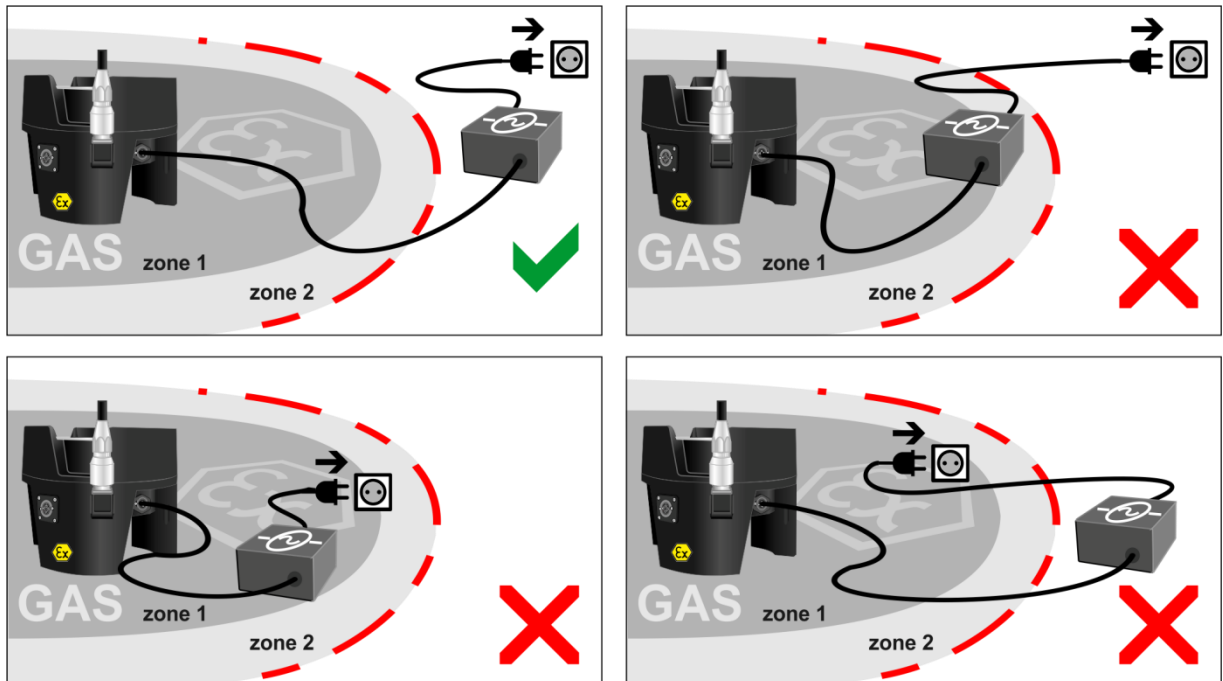



Fig. 4.3: X-zone Com's power supply unit and its source of power must always be outside the designated ex zones.

Ambient temperatures during the charging process should be between +5°C and +30°C, otherwise the charging process may take longer (see Chapter 6.4).

**WARNING**





**Explosion hazard**  
Never connect the power supply unit to the mains inside the ex zone when charging X-zone Com.

**NOTE**



Please fully recharge the battery at least once every six months to avoid exhaustive discharge and damage to the battery.  
Store X-zone Com outside the explosion exposed area in off modus keeping it connected to the power supply unit.

You may observe X-zone Com's charging progress via a display (see Ch. 6.4).

	<ol style="list-style-type: none"><li>1. Battery exhausted (X-zone Com automatically switches off)</li><li>2. When the battery is connected to the charger, the symbol indicates overheating and a temporary stop of charging. When the temperature drop, the charging will be continued.</li></ol>
	Battery charge 100%

## 4.2.2 Inserting the SIM card

To send e-mail and text messages with X-zone Com, the internal modem must have an SIM card.

To use the GSM modem, customer M2M SIM cards that are suitable for data and text (SMS) communication are necessary. Customers should obtain contracts with providers that provide the required data volume and sufficient number of text messages. SIM cards that are also suitable for voice communication (also applies to twin cards) or that are mainly intended for use with smartphones, tablets or USB/GSM sticks, should first be activated and tested using an appropriate smartphone/tablet/USB GSM stick. Services such as forwarding of voice services or similar should be disabled. The SIM card can be used only in X-zone Com's GSM modem after the activation/setting is completed.

**WARNING**



**Explosion hazard**  
Do not open the product housing inside an ex atmosphere!  
Insert or remove SIM cards only in safe non-explosive atmospheres.



Fig. 4.4: Opening the X-zone Com housing (C = power plug, A = antenna socket).

#### NOTE



*Isolate the modem from the mains supply by pulling the mains plug before opening the modem housing.*

To insert the SIM card, proceed as follows:

1. Unscrew the 6 screws on the bottom of the X-zone Com device.
2. Carefully lift off the X-zone Com's top.
3. Isolate the modem from its power supply.
4. If necessary, remove the modem from its retaining clip.
5. Unscrew the lid of the modem (see Fig. 4.5).
6. Release the card holder by sliding it in the direction of the arrow and then flip it open (see Fig. 4.5).
7. Insert the SIM card into the holder.
8. Flip the cardholder shut and lock it by sliding it back to its original position.
9. Screw the lid of the modem back on.
10. Reconnect the modem to its power supply.
11. Put the top back on, making sure the seal fits properly.
12. Tighten the 6 screws hand tight.



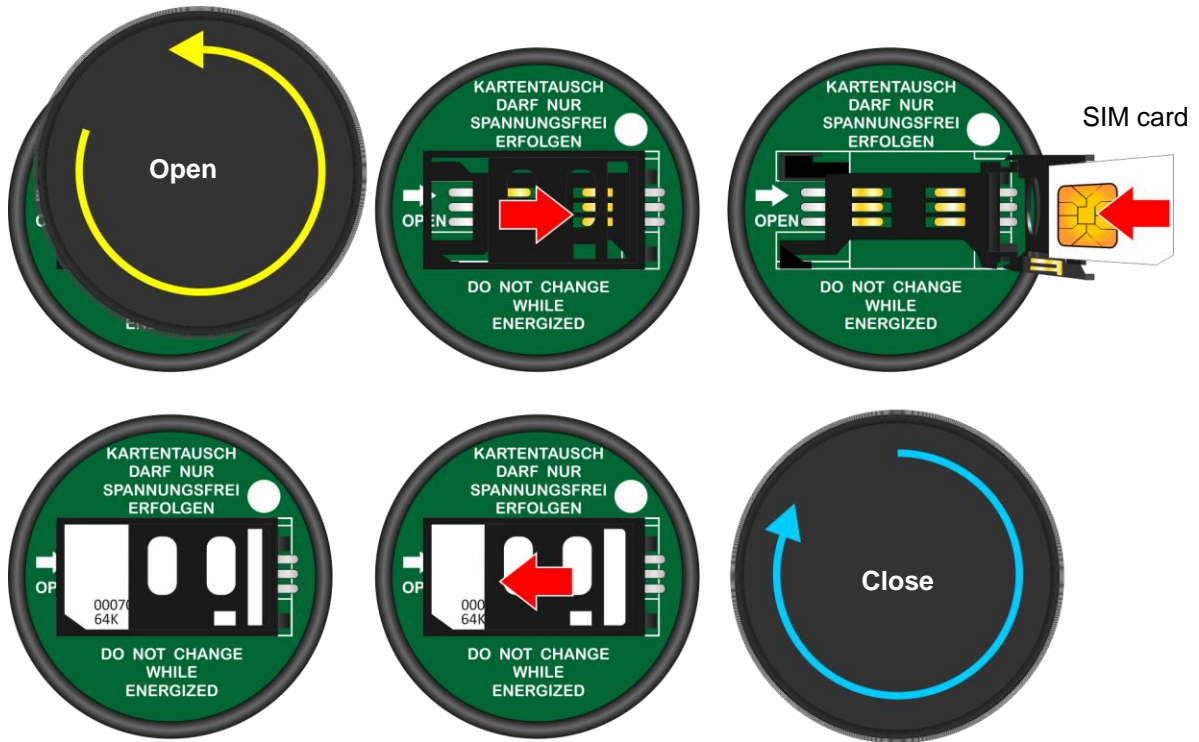



Fig. 4.5: Insert the SIM card by unscrewing the lid of the modem, sliding the card holder in the direction of the arrow and then flipping it open.

### 4.2.3 Antenna installation/removal

<b>WARNING</b>	
	<p><b>Explosion hazard!</b> Only the original antenna (ORI-order-no. 8094108, Dräger Order no. 8324372) should be connected to the antenna socket.</p>

Do not twist the antenna rod when installing or removing the antenna. To tighten or loosen the antenna, turn the connector nut to avoid disconnecting the centre contact at the antenna base (Fig. 4.6).



Fig. 4.6: HF socket on X-zone Com

## 4.2.4 Connecting the X-zone 5x00

Use the yellow RS485 connection cable enclosed (article no. 8094118) to connect X-zone Com's K3 connector to the X-zone 5x00's XEXT2 connector. Please ensure that the right angle plug on X-zone Com points downwards.

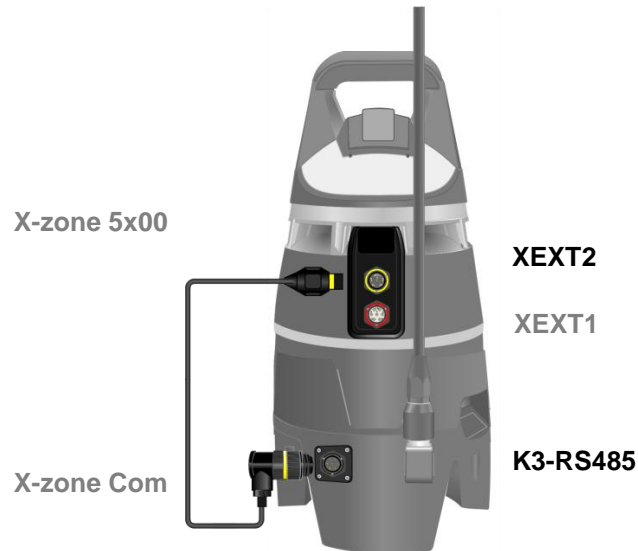

Fig. 4.7: Connecting X-zone Com to X-zone 5x00 using the RS485 connection cable.

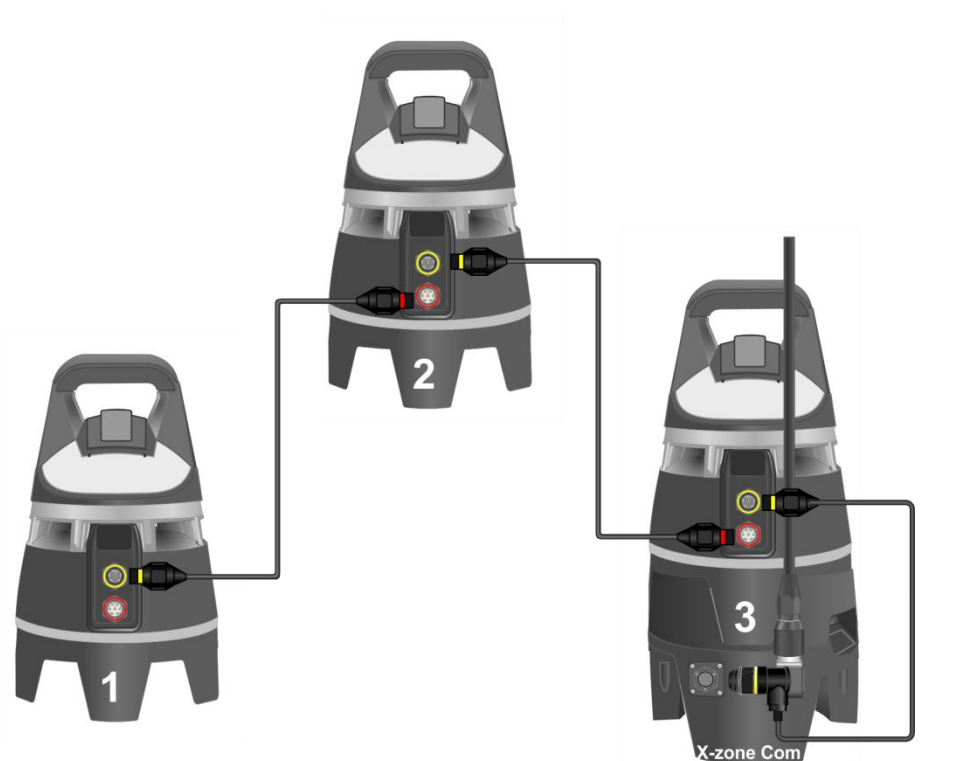



Fig. 4.8: When connecting several X-zone 5x00s via communication cable only, connect X-zone Com to the X-zone 5x00 at the end of the cable chain.

**NOTE**



The use of an X-zone Com that is connected to an X-zone 5x00 requires firmware version 2.22 or higher.

To update the firmware and to configure the X-zone 5x00 by means of the PC software Dräger CC-Vision, please contact your Dräger customer account manager.

Please ensure modbus is enabled for X-zone 5x00. Use the PC software Dräger CC-Vision to configure as follows:

X-zone 5x00 Modbus settings	
Modbus connector	XEXT2
Modbus address	2
Baud rate	115200
Parity	Even

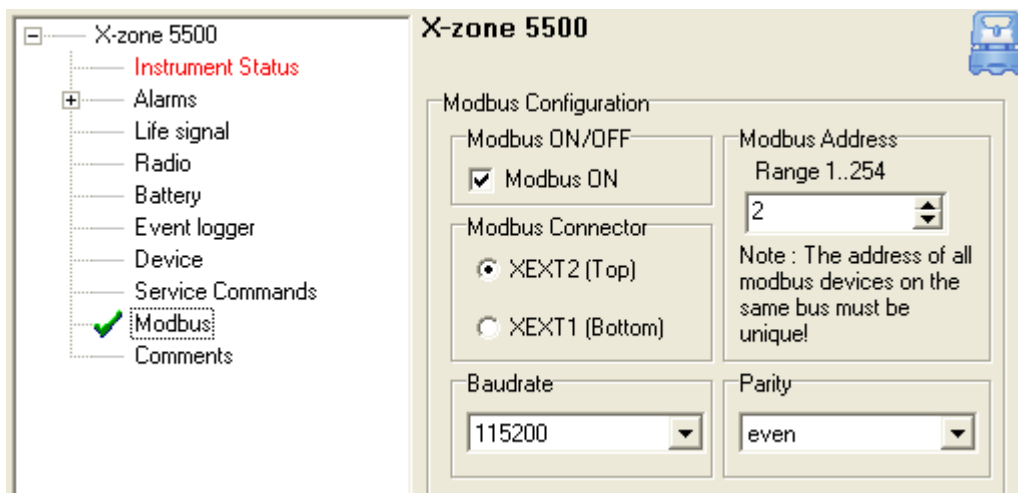

Fig. 4.9: Modbus settings in the PC software Dräger CC-Vision.

**Difference between closed and open network:**

A detailed description of the network functionalities can be found in the Dräger X-zone 5x00 operating manual.

*“In a closed wireless network, one master device monitors the wireless link to all group devices and all group devices monitor access to the master device. Should a device fail, e.g. due to a dead battery, or if the device is removed, a device alarm triggers on the master device. If the master device fails, an alarm sounds on all group devices.”*

The following table shows the different actions of X-zone Com. The use of the serial or station number and of local measured values or maximum values applies both to e-mails and text messages sent by X-zone Com, and to the internet data portal Mcloud and the Manager Software.

	Open network	Closed network (group)
<b>X-zone 5x00 identification number</b>	Serial number	ID used by group individuals (station number)
<b>Measurement reading used for a gas</b>	Current measured value of the connected X-zone 5x00	Current maximum measured group value
<b>Alarm information</b>	✓	✓
<b>Maximum number of X-zone 5x00s in the network</b>	25	15

#### NOTE



*X-zone Com may be connected to any X-zone 5x00 in the wireless network. It is not necessary to connect it to the main device, e.g. in a closed network.*

#### NOTE



*X-zone Com transmits a signal to X-zone at regular intervals. If the connection is lost for more than 1 minute X-zone 5x00 will indicate a device error.*

### 4.3 DISCONNECTING FROM X-ZONE 5X00

If the connection between X-zone Com and X-zone 5x00 is interrupted for more than 1 minute, X-zone 5x00 will indicate a device error. To avoid this, leave the RS485 connection in place until you have switched off X-zone Com (see Chapter 6.3). This will prevent a device error.

## 5 CONFIGURING X-ZONE COM

To configure X-zone Com, you need the Manager Software, which installs as described in Chapter 4.1.

### 5.1 ESTABLISHING PC-CONNECTION

X-zone Com connects either via wireless Bluetooth or via a cable to PCs.

#### 5.1.1 Bluetooth connection

The following describes how to establish a Bluetooth connection using Windows 7. Depending on the operating system, the procedure may differ slightly.

1. Ensure that the Bluetooth module on your PC is enabled. In most cases this is done by pressing the blue marked function keys [FN]+[Bluetooth symbol].
2. Check that X-zone Com is in operation with a fully charged battery.

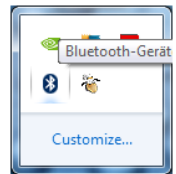

Once the Bluetooth module is active, right-click on the Bluetooth symbol  on the Windows toolbar and select [Add device].

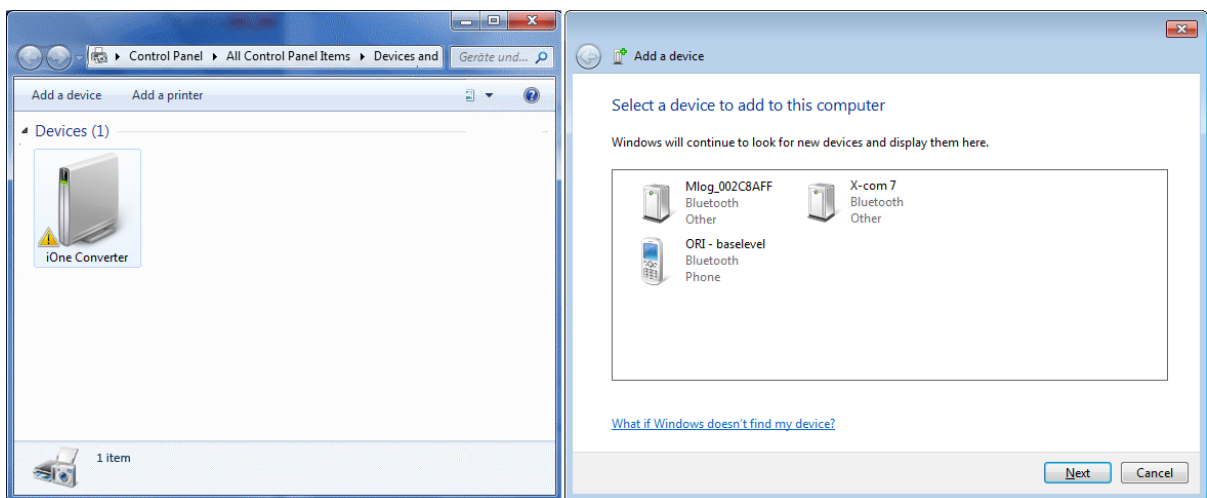

Fig. 5.1: Connecting X-zone Com via Bluetooth.

Now select the device and click [Continue]. If you are connecting to X-zone Com for the first time, please confirm the connection pin displayed (applies for MS Windows 7). Clicking [Continue] adds X-zone Com to the Bluetooth network devices of the PC used.

MS Windows assigns a COM port number to any established Bluetooth connection. To view this number, highlight the device and click [Properties]. Then select the [Services] form (see Fig. 5.2).

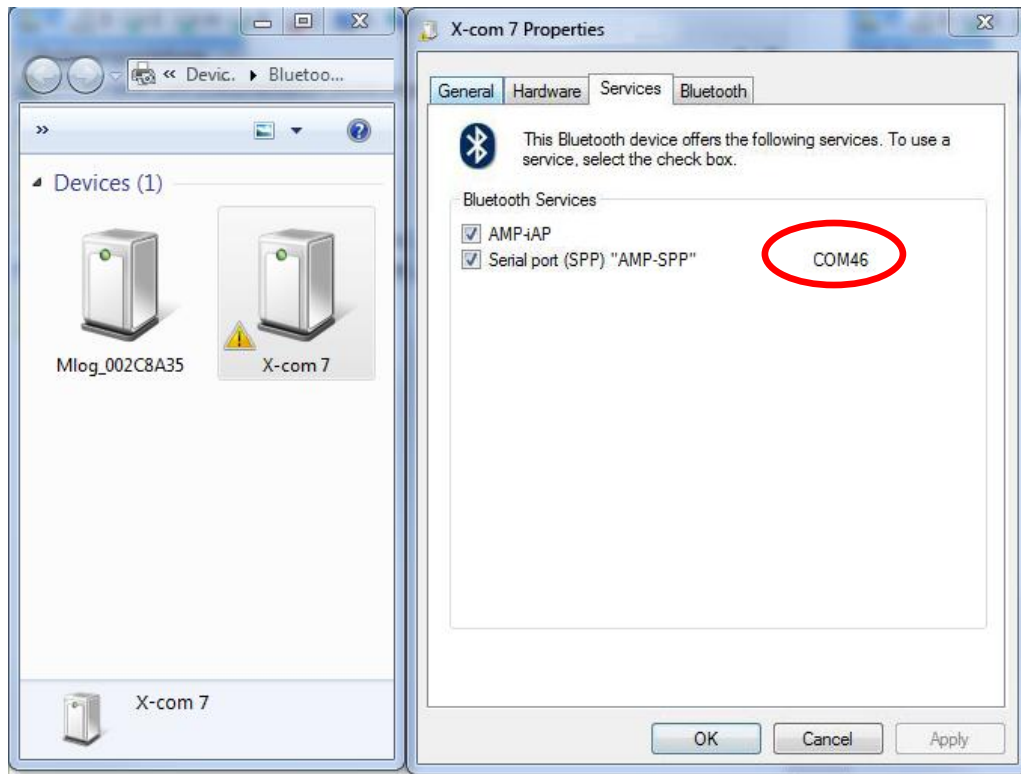

Fig. 5.2: Assigned COM-Port in MS Windows 7.

The Manager Software identifies the COM Port automatically. To accelerate the connection process, set the COM Port using the Manager Software.

### 5.1.2 Cable-based connection

Alternatively, you may connect X-zone Com to a PC's K2 interface (RS232) with the enclosed cable. The PC normally requires a USB serial adapter for this.

If you are using this option, the Manager Software (automatically or manually set) will require the COM Port number assigned by MS Windows.

## 5.2 OVERVIEW/START VIEW

The main window of the Manager Software has 5 areas of function, which are described in the following.

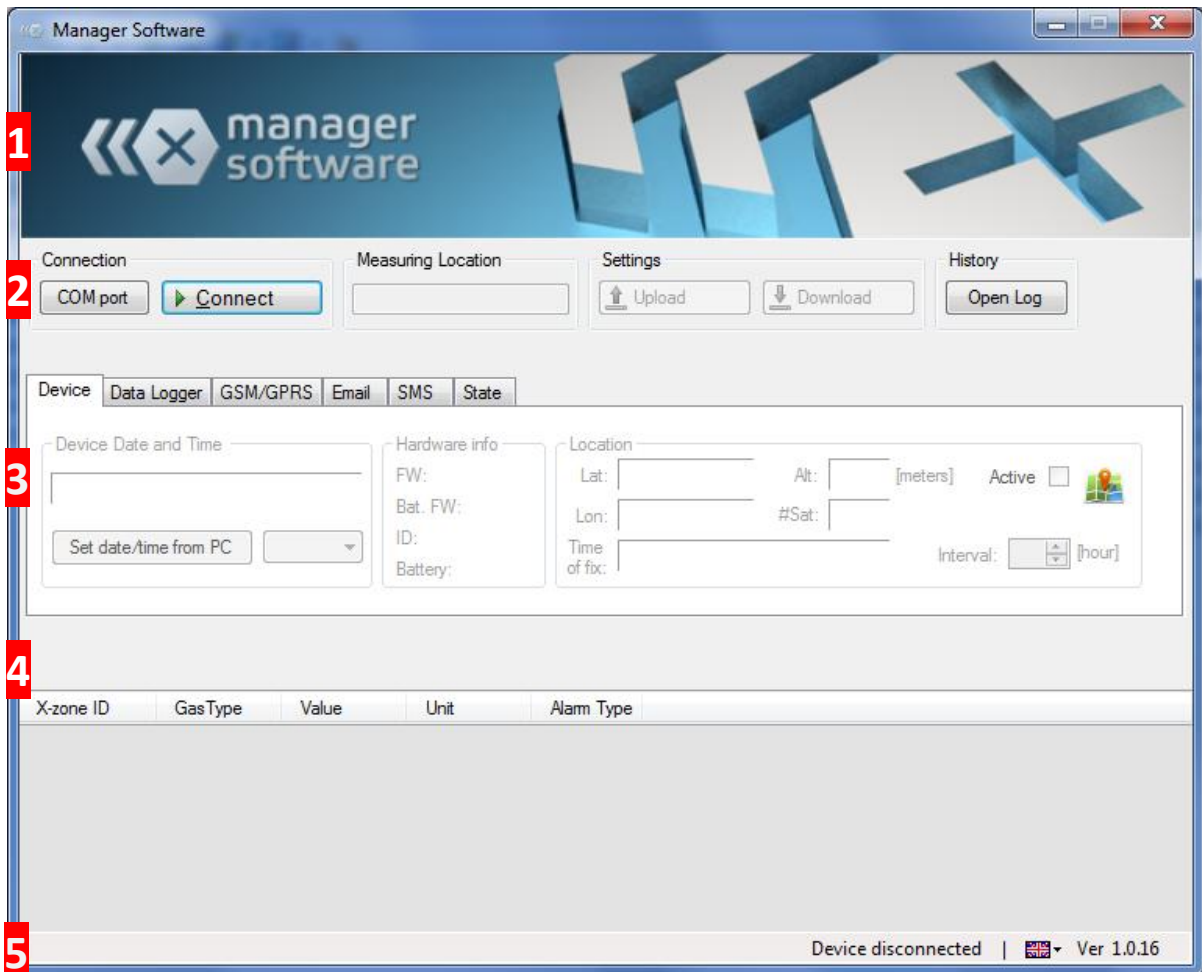

Fig. 5.3: Main window of the Manager Software.

<b>1</b>	<p><b>Logo</b></p> <p>The logo is linked to the ORI website (<a href="http://www.origmbh.de/">http://www.origmbh.de/</a>), so it requires internet access.</p>
<b>2</b>	<p><b>Connection functions</b></p> <p><b>Connection:</b></p> <p>[COM Port]: Allows you to select a COM Port.          [Connect]: Establishes a connection between a PC and X-zone Com.          [Disconnect]: Disconnects a PC and X-zone Com.</p> <p><b>Device name:</b></p> <p>User-given device name of X-zone Com.</p> <p><b>Settings:</b></p> <p>[Upload]: Allows you to apply settings to X-zone Com.          [Download]: Select and display current device settings.</p> <p><b>Data history:</b></p> <p>[Open Log] Loading of BSH data files for viewing. Export function.</p>

3	<p><b>Configuration:</b></p> <p>Select device, log, and communication settings. In addition, shows various types of information, such as device ID, device status, and battery status.</p>
4	<p><b>Measuring values:</b></p> <p>In an open network, displays current readings of locally connected X-zone 5x00. In the event of an alarm, the alarm data of the device issuing the alarm also appear.</p> <p>In a closed network, displays current maximum and alert values from the group.</p>
5	<p><b>Status bar</b></p> <p>Shows the status of the connection to X-zone Com.</p> <p>Also allows the language selection of Manager software and shows the Manager Software version.</p>

## 5.3 CONNECTION INFORMATION

### 5.3.1 Connecting to X-zone Com

PCs and X-zone Com connect via a RS232 connection cable or Bluetooth. When you use a RS232 cable, usually, the system assigns COM Port 1.

**NOTE**



*To connect using Bluetooth, enable the PC's Bluetooth module. The operating system will also have to assign a virtual ComPort to the device. Further information can be found in Chapter 5.1.*

The Manager Software can search for the COM Port for the serial Bluetooth connection automatically, or you can assign the COM Port manually.

#### 5.3.1.1 Automatic search

If the software has been installed, its default setting is automatic search and it will search for a COM Port. Make sure [AutoDetect] is checked, as shown in **Fehler! Verweisquelle konnte nicht gefunden werden..**

Click [Connect] to start the connection process. The status bar will show "*Searching device at:*" and will also indicate at which COM Port the system is searching for a device.

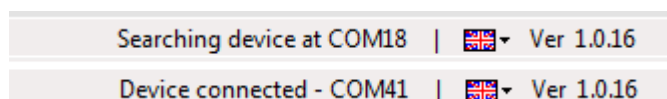

Fig. 5.4: Software status bar seen when the system has successfully completed the connection.



### 5.3.1.2 Manual COM Port selection

**NOTE**

Selecting the ComPort manually makes sense when you have several X-zone Coms. If you don't perform this manually, the system will connect to the first X-zone Com it finds.

To select the COM Port number assigned by the operating system manually, click the [COM port] button. The 'COM Port' window shown below will open. Deselect [Automatic search] and then select the COM Port number assigned to X-zone Com from the list by the operating system.



Fig. 5.5: Manually selecting the virtual COM Port of the Bluetooth or serial interface.

### 5.3.2 Change device designation/measuring site name

You can assign a name (e.g. a site where you take readings/measurements) to X-zone Com at "Measuring Location" (the following characters are not allowed: \$, °, German umlauts, and ß). All transmitted readings will appear in the ORI Mcloud portal under this name. The device comes with a name that is the same as the device ID of X-zone.

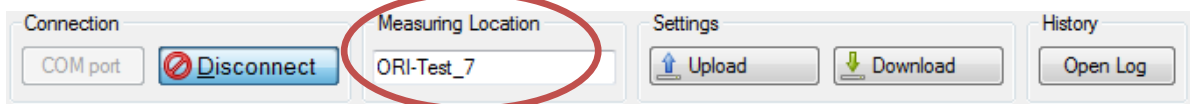

Fig. 5.6: Assigning a name to X-zone Com.

Clicking [Upload] assigns the name to X-zone Com. The maximum number of characters for the name is 10. The system does not accept German umlauts (i.e. ä, ö, ü) and special characters. If no name or an invalid name is assigned, the system will not transmit the settings X-zone Com and an error message will appear.

**NOTE**

The assigned device name is required for the registration of X-zone Com in Mcloud.

### 5.3.3 Saving and loading X-zone Com settings

If all entries are valid, the system will write the selections to X-zone Com when you click [Upload]. Invalid entries appear in red and may not be saved.

Clicking [Load] reads the current settings from X-zone Com and displays them in the Manager Software.



Fig. 5.7: Sending settings to and reading settings from X-zone Com.

### 5.3.4 Show data history

**NOTE**

You don't have to connect to X-zone Com to be able to use the data history in the Manager Software.

If you click [Open Log] under "History", a window opens that allows you to open BSH data files sent by e-mail. To select a recorded measurement, click the [...] button and select the file you require. Clicking on [Load] displays the selected file's measured readings in a table in the [Data] template.

Type	Date Time	Gas Type	Value	Unit	Alarm Type	X-zone ID
L	25.04.2014 07:43	O2	20,9	Vol%	OK	AREH-0008
L	25.04.2014 07:43	ch4	0	%UEG	OK	AREH-0008
L	25.04.2014 07:43	O2	20,9	Vol%	OK	AREH-0008
L	25.04.2014 07:43	ch4	0	%UEG	OK	AREH-0008
L	25.04.2014 07:43	O2	20,9	Vol%	OK	AREH-0008
L	25.04.2014 07:43	ch4	0	%UEG	OK	AREH-0008
L	25.04.2014 07:43	O2	20,9	Vol%	OK	AREH-0008
L	25.04.2014 07:43	ch4	0	%UEG	OK	AREH-0008
L	25.04.2014 07:44	O2	20,9	Vol%	OK	AREH-0008
L	25.04.2014 07:44	ch4	0	%UEG	OK	AREH-0008
L	25.04.2014 07:44	O2	20,9	Vol%	OK	AREH-0008

Fig. 5.8: Table showing the recorded measurements of a loaded BSH data file in the data viewer.

Explanation of some of the columns in the table:

Table Column	Value	Meaning
Type	L	Local reading
	M	Maximum level of the gas for the group
	E	Error
Value		Logged gas measurement value
Unit	Vol%, %UEG, %LEL, %LIE, ppm, mg/m3, ppb, mbar, hPa, kPa, mg/L	Unit of measurement

Alarm type	OK	Reading is within the approved range
	A1	A1 Alarm
	A1_Q	A1 Alarm acknowledged
	A2	A2 Alarm
	A2_Q	A2 Alarm acknowledged
	Err	Device error
	Err_Q	Device error acknowledged

To export the data sets in a CSV file, use the [Save as] button. Then select the directory in which the file is to be saved and decide whether the data sets should be opened by the spreadsheet software installed on your PC.

Select the [Device] template to view the device, GPS, alarms, and battery capacity information contained in the data file.

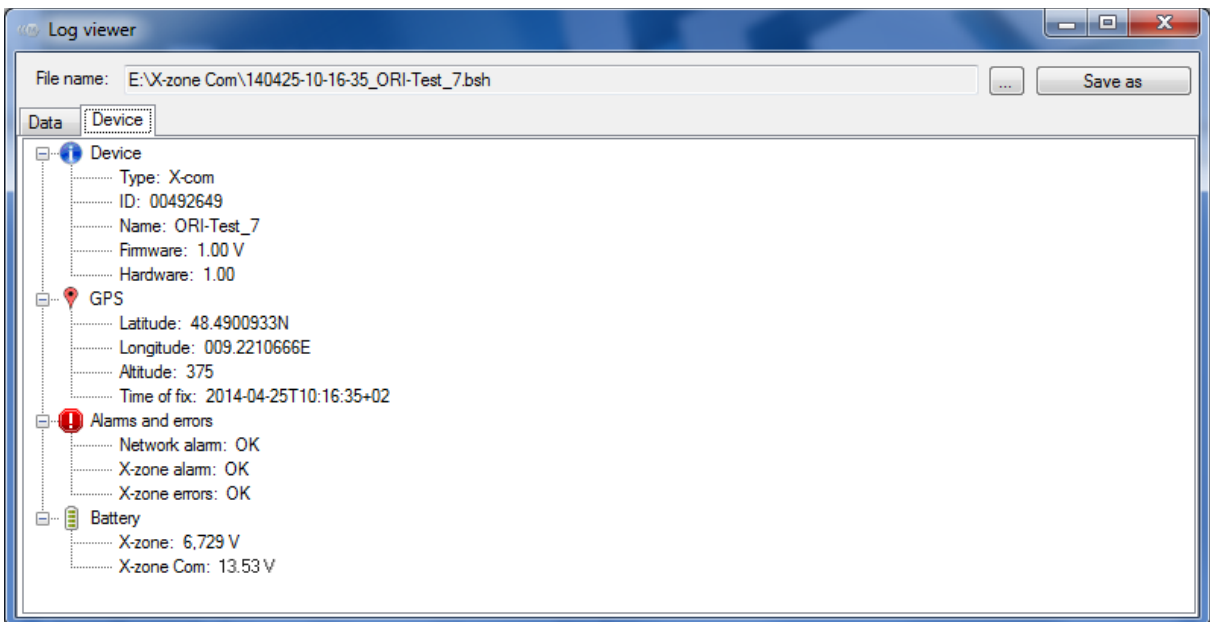

Fig. 5.9: X-zone Com log transmitted in the BSH file shown in [Device] log.

## 5.4 CONFIGURING X-ZONE COM

The configuration area of the window shows current X-zone Com settings. The individual tabs are explained below.

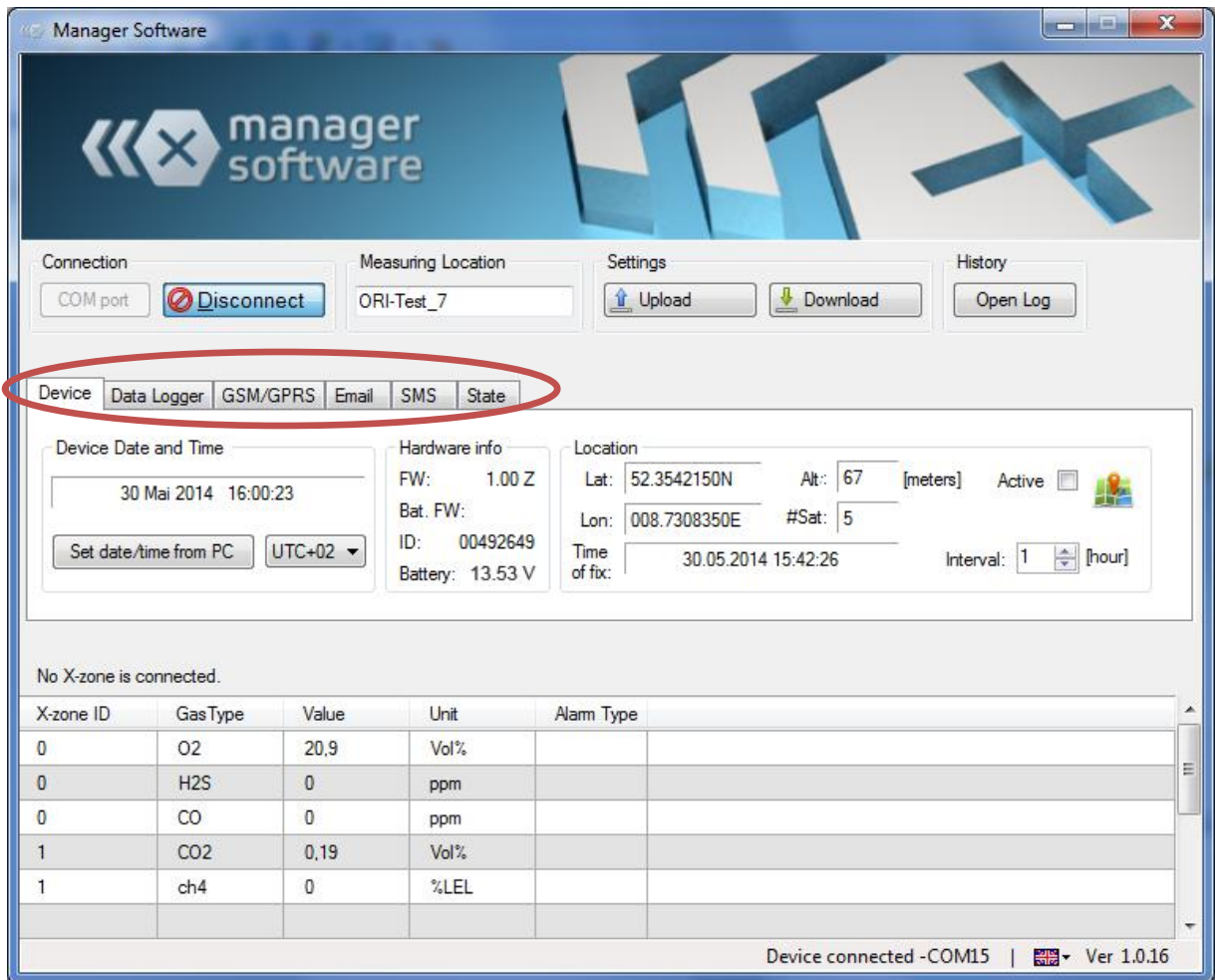

Fig. 5.10: Various tabs for general settings, data logger, GSM, e-mail, and text message settings.

With the exception of device date and device time, all settings made have to be sent to X-zone Com using the [Upload] button (Settings).

## 5.4.1 "Device" tab

The "Device" tap permits you to make general device settings and view information.

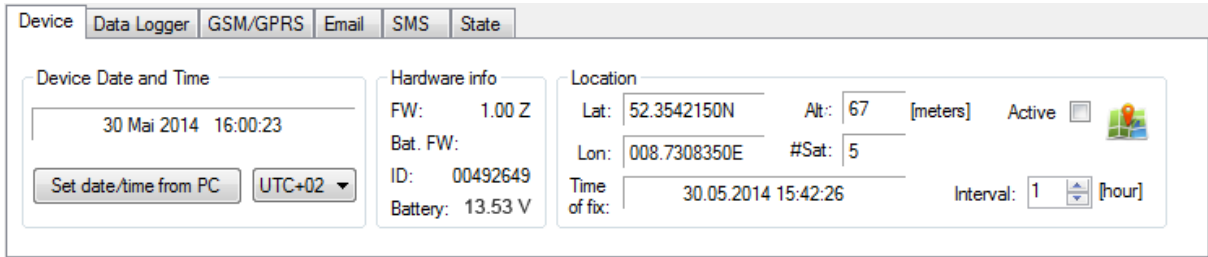

Fig. 5.11: General device information, e.g. current device time and GPS coordinates.

**Device date & time:** The time displayed consists of the "Universal Time Coordinated [UTC]" and the time zone, e.g. Central Europe:

1. Standard: UTC+1
2. Summer time: UTC+2

Clicking on the [PC date/time] button sets the device's date and time to the PC's current date and time. It applies the selected time zone (UTC+1 in Central Europe). Check the PC clock's accuracy before synchronising the times.

**NOTE**

If a GPS signal is available, the system will use GPS time. If the clock is not set, the time at which the X-zone Com began operation serves as the basis for the timestamps until a GPS signal is received.

**Info:** The Info Area shows the version number of the firmware, the identification number, and the X-zone Com's current charge in volts.

**Location:** "Location" is where you can view the determined position data, the number of GPS satellites used, and when the position was determined. Use "Interval" to set how often the GPS position is determined. The example below shows an interval of one hour. (**Fehler! Verweisquelle konnte nicht gefunden werden.**). Using short GPS intervals will expend the battery charge more quickly.

Click on the card symbol and the position of the device will appear in Google Maps, provided the coordinates are available. You'll require a browser and internet access.

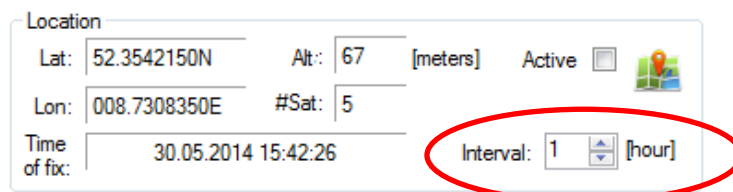

Fig. 5.12: Frequency at which position is determined.

## NOTE



The interval may be set for 0 to 24 hours. Selecting "0" disables the GPS module completely.

X-zone Com automatically tries to determine its GPS coordinates when you turn it on. During operation, it continues to determine coordinates at your chosen frequency. Check the [Active] box to activate this function.

Location	
Lat:	52.3542150N
Alt:	67 [meters]
Lon:	008.7308350E
#Sat:	5
Time of fix:	30.05.2014 15:42:26
Interval:	1 [hour]

Fig. 5.13: Selecting the checkbox immediately activates the coordinate finding function.

Whilst the device is determining the GPS coordinates, the [Active] checkbox's lettering will alternate between grey and black. Once GPS parameters have been determined, this will cease and the coordinates will appear. The [Active] checkbox is still active and the time and date when the coordinates were determined ("Determined on") appear as recorded by the system. For the duration of a single minute, the device will try to obtain a more accurate result, after which the [Active] checkbox and the GPS module will deactivate.

Any attempt to determine the position will end after 10 minutes if unsuccessful. After that, the GPS module switches off to save energy. If the GPS module could not determine the position, the system will use the last established position. The GPS symbol is crossed out in the display of X-zone Com (see Chapter 6.4.1).

## 5.4.2 "Data logger" tab

X-zone Com saves all measurements and events transmitted by X-zone 5x00. The interval at which readings transmit configures to meet specific requirements.

## NOTE



All selected settings have to be sent to X-zone Com once. To do so, click [Upload].

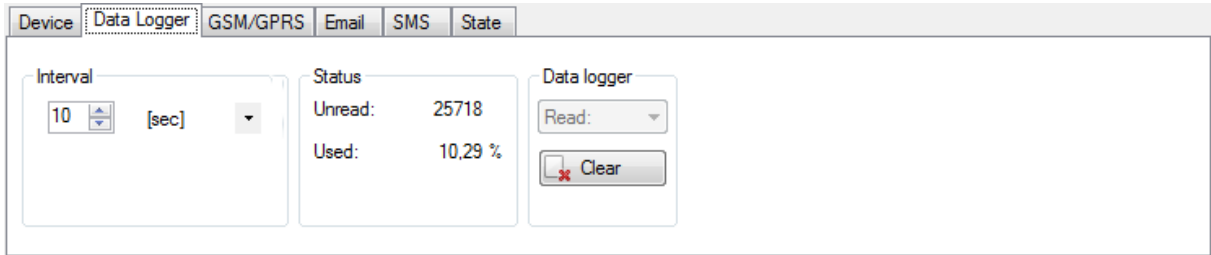



Fig. 5.14: The "Data logger" tap allows you to set the logging interval, view the status and clear the data memory.

**Interval:** "Interval" permits users to determine the transmission and storage frequency of the measurement results. You may select either seconds (10-59 sec.) or minutes (1-60 min.).

**Status:** "Total" displays the number of saved data sets and "unread" shows the number of data sets not yet sent. In addition, you'll see the available memory capacity.

**NOTE**

 *The data logger is designed as a circular buffer, i.e. it overwrites the oldest data when the memory is full.*

**Daten logger:** [Delete] empties the device's data memory. You will be asked if you are sure you want to delete the contents before the system proceeds.

### 5.4.3 "GSM/GPRS" tab

To use the GSM/GPRS network to communicate data, you have to make several settings. These settings will vary depending on your mobile phone provider. You may have to ask your provider to supply this information.

**NOTE**

 *You have to transmit every setting you make once to X-zone Com, by clicking [Upload].*

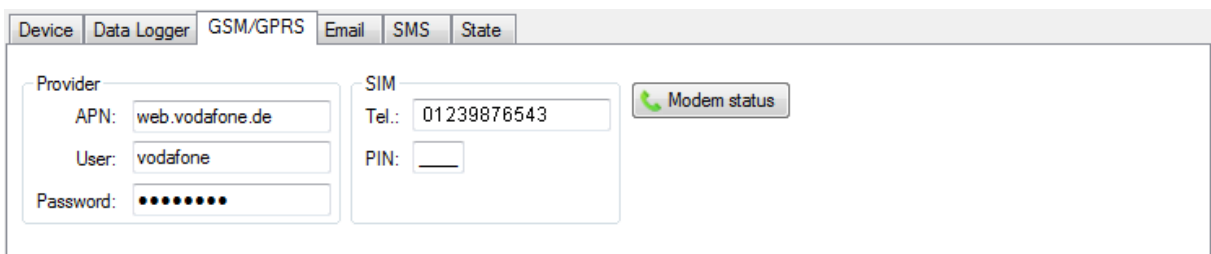

Fig. 5.15: Mobile phone settings. You can obtain the settings you need to use for the SIM card you installed from your mobile phone provider. Click [Modem status] to display the connection parameters and carry out a function test.

<b>APN</b>	<p>Access Point Name of your mobile phone provider. Entered when you insert new SIM cards.</p> <p>Some examples of access points in Germany (provided without guarantee of accuracy)</p> <table border="1"> <thead> <tr> <th>Provider</th> <th>APN</th> <th>User</th> <th>Password</th> </tr> </thead> <tbody> <tr> <td>T-Mobile</td> <td>internet.t-mobile</td> <td>t-mobile</td> <td>tm</td> </tr> <tr> <td>Vodafone</td> <td>web.vodafone.de</td> <td>n/a</td> <td>n/a</td> </tr> <tr> <td>O2</td> <td>internet</td> <td>n/a</td> <td>n/a</td> </tr> <tr> <td>EPLUS</td> <td>internet.eplus.de</td> <td>eplus</td> <td>internet</td> </tr> </tbody> </table>	Provider	APN	User	Password	T-Mobile	internet.t-mobile	t-mobile	tm	Vodafone	web.vodafone.de	n/a	n/a	O2	internet	n/a	n/a	EPLUS	internet.eplus.de	eplus	internet
Provider	APN	User	Password																		
T-Mobile	internet.t-mobile	t-mobile	tm																		
Vodafone	web.vodafone.de	n/a	n/a																		
O2	internet	n/a	n/a																		
EPLUS	internet.eplus.de	eplus	internet																		
<b>User</b>	User name for internet access																				
<b>Password</b>	Your password for internet access																				
<b>Tel.</b>	Phone number of the SIM card inserted into the modem. Manual input																				
<b>PIN</b>	The PIN for the SIM card inserted into the modem, if PIN protection is enabled. Otherwise leave blank. Is needed when switching on/powering up the device.																				

Click [Modem status] and the modem will attempt to establish a connection to the network.

If you see an IP address, the modem has successfully accessed the network.

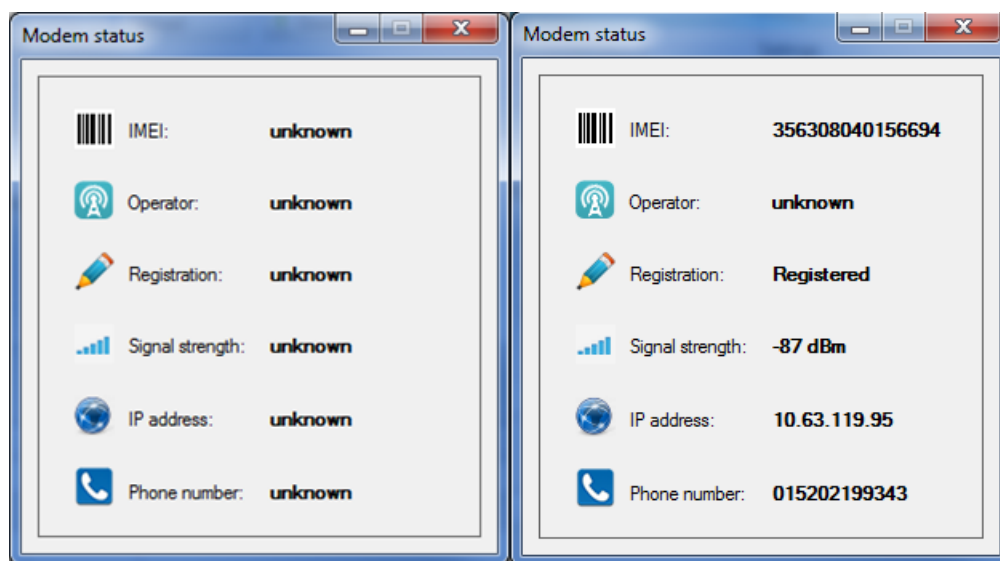

Fig. 5.16: The modem status window displays all relevant access information. The phone number will be only visible, if it has previously been entered in the input field.

#### 5.4.4 "Email" tab

X-zone Com sends out e-mails containing measurements at regular, configurable intervals. In the event of an alarm, it sends the message immediately. In both cases, it transmits all unsent readings and alarm values.



**NOTE**

You have to transmit every setting you make once to X-zone Com, by clicking [Upload].

Fig. 5.17: E-mail settings, such as SMTP server, sending and recipient addresses, sending frequency and which alarms warrant the sending of a message between intervals.

**SMTP:** "SMTP" is where you make the settings required for sending e-mail and using Mcloud.

<b>Server</b>	Your outgoing post server
<b>User</b>	User name for e-mail access
<b>Password</b>	Your password for e-mail access

**Addresses:** "Address" is where you enter the sender and recipient addresses.

<b>From</b>	Sender address (user-specified in acc. with provider specifications)
<b>To</b>	E-mail recipient (max. 1 recipient).
<b>CC</b>	E-mail recipient (max. 1 copy recipient).

**Send interval:** "Send interval" is where you can set the frequency by which the system sends e-mails (5/10/15/30 min; 1/2/3/4/6/8/12 hrs; 1 day). Once you have saved the settings, the first e-mail will go out at the next interval.

Mark the "Mcloud" checkbox to transmit the data to Mcloud (see the separate Mcloud user's manual).

**Alarm sending:** "Alarm sending" allows you to determine under which alarm circumstances your system immediately sends an e-mail and transmits the information to Mcloud.

Test provider information and recipient addresses to see if everything functions as it should (see Chapter 6.5). This will prompt the system to send an e-mail immediately.

## 5.4.5 "SMS" tab

Configure X-zone Com so that in the event of an alarm, the system sends text messages (SMS) to telephone numbers specified by the operator. In addition, the operator can check the current status and send instructions to X-zone Com via text message (see Ch. 7).

**NOTE**

You have to transmit every setting you make once to X-zone Com, by clicking [Upload].

Fig. 5.18: Settings for sending text messages (SMS). Here is where you determine what the text message shall say if an alarm situation occurs. On the far right, is where you enter the "Read" and "Execute" pins.

Form "SMS" permits you to determine up to four text message recipients of alarm messages. To add recipients, click [Add] and enter the phone numbers. With [Delete], you can remove a phone number if you have highlighted it. If there are no telephone numbers, the system won't send text messages. It is also possible to set a limit to the number of text messages the system sends daily. (1-99 text messages a day). This requires you to check the [Max. Alarms/Day] box. If you don't check the box, there is no limit to the number of text messages per day.

**Content:** "Content" allows you to specify character sequences (do not use the following characters: "\$", "°", German umlauts or "ß") that follow the device name in every alarm text message. In addition, you can specify if you want the alarm text message to contain the current measurement reading and the ID of the X-zone 5x00 that issued the alarm, or if you'd prefer the message to contain only the alarm type and gas type.

**Alarm Sending:** "Alarm Sending" is where you can determine which alarm circumstances will trigger an alarm text message.

Alarm type	Meaning	
<b>A1</b>	Concentration pre-alarm	<b>Explanation:</b> Gas type O2 = oxygen deficiency
<b>A2</b>	Concentration main alarm	<b>Explanation:</b> Gas type O2 = oxygen excess
<b>Device error</b>	X-am 5x00 or X-zone 5x00 device error. Device or several sensor channels are not operating. X-zone Com device errors in Ch. 10.1.	

**NOTE**

Read the explanations of the types of alarm in the X-am 5x00 guide carefully.

**PIN:** You can specify two PINs that X-zone Com will accept as valid for text message queries. Text messages sent to the X-zone Com must contain the PINs. The "Reader PIN" is necessary to allow recipients to read the message and the "Admin-Pin" allows the recipient to take actions that may alter the situation. X-zone Com reacts only if messages contain a valid PIN and will ignore all messages without valid PINs. You'll find more detailed information on text message options in Ch. 7.

Check all the telephone numbers that have been entered, subjecting them to a function test (see Ch. 6.5). If your settings specify that the phone number you are testing should receive a text message for at least one of the alarm situations, the function test will trigger at least one text message immediately.

Example of an alarm text message:

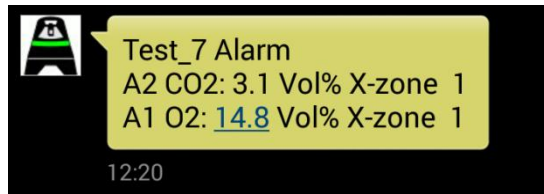



Fig. 5.19: Example of an alarm text message. Seen here is a X-zone Com sent "Test\_7", containing an A2 Alarm for CO2 and a A1 Alarm for oxygen, read by an X-zone group device with ID 1.

**NOTE**



Only the sender of the query text message receives a reply.

## 5.4.6 "Status" tab

The "Status" tab displays a list of the connected X-zone Com's hardware and functions and their statuses. Green checks indicate they are capable of operating.

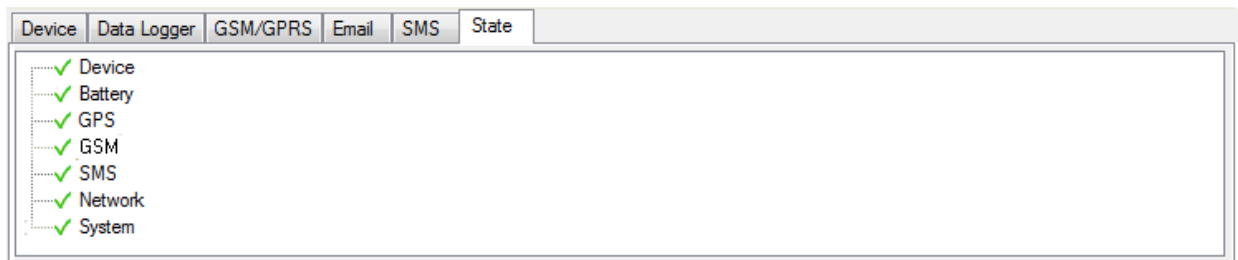

Fig. 5.20: All the X-zone Com's functions and devices are ready for operation.

A red cross indicates device error or failure. Click on the plus symbol to view the details.

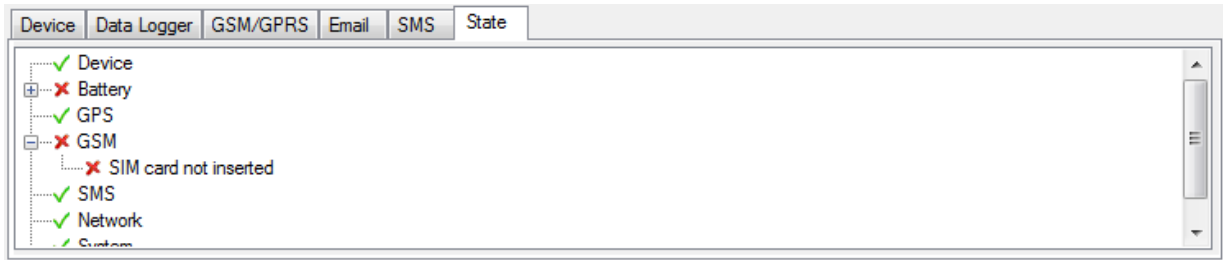

Fig. 5.21: There are two errors.

## 5.5 MEASUREMENTS SECTION

Displays the current readings and alarms

Current MAXIMUM sensor values.				
X-zone ID	Gas Type	Value	Unit	Alarm Type
0	O2	19,8	Vol%	A1
0	H2S	0	ppm	
0	CO	0	ppm	
0	CO2	0.25	Vol%	A2
1	ch4	0	%LEL	

Fig. 5.22: Readings and alarms in the Manager Software's Measurements Section. Group device 0 triggered both alarms.

The table shows the identification number for the group's X-zone 5x00 for each device from which readings were taken. It also displays the type of gas, current gas concentration and its unit of measurement, as well as alarm type, if in fact, an alarm was triggered.

Above the table, you'll find information stating whether the connected X-zone 5x00 belongs to a open or closed network (group) and if the reading is a local value or a maximum value of a group (see Ch. 4.2.4).

Heading	Meaning
Current, LOCAL sensor readings (no closed groups configured)	<b>Open network:</b> Displays sensor readings of the local X-zone 5x00 that is connected to X-zone Com.
Current MAXIMUM sensor readings (the connected device is not a master)	<b>Group:</b> Maximum current readings taken from all the different gasses in the network
Current MAXIMUM sensor readings	<b>Group:</b> Maximum current measured value taken from all the different gasses in the network
Not connected to X-zone 5x00	Not communicating with X-zone

## 6 X-ZONE COM CONTROLS

The following explains how to use X-zone Com's controls.

### 6.1 OPERATOR CONTROL PANEL

X-zone Com has an OLED display where the most important information appears. There are two buttons that operate with a magnetic pen.



Fig. 6.1: X-zone Com control panel.

The buttons have the following functions:

	<b>ON/OFF</b> button allows you turn the device on or off.	<b>Depress long</b>	ON (approx. 3 Sec.) OFF (approx. 3 sec.)
	<b>Function button</b>	<b>Touch briefly</b>	Returns you to overview
		<b>Depress long</b>	Perform a function test
		<b>Touch briefly</b>	Turn to the next screen page if there is an error. This will end a function test while it's in progress.

### 6.2 TURNING ON THE DEVICE

To turn X-zone Com on, press the left button (ON/OFF) with the magnetic pen for about 3 seconds. A countdown starting at 3 will take place on the display.

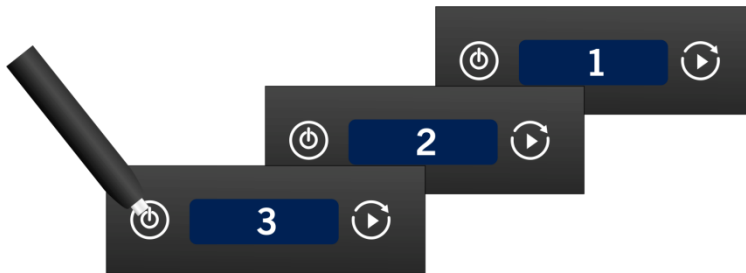

Fig. 6.2: Start countdown.

**CAUTION**

*Only operate X-zone Com within the specified temperature range.*

When you turn X-zone Com on, it will automatically attempt to log in to the GSM network and determine the GPS coordinates. The X-zone Com will not turn on if the battery is spent.

If there is not a SIM card in the modem, Error x21 "no SIM card" will appear.

## 6.3 TURNING OFF THE DEVICE

To turn off X-zone Com, press the (ON/OFF) button with the magnetic pen for about 3 seconds. A countdown starting at 3 will take place on the display.

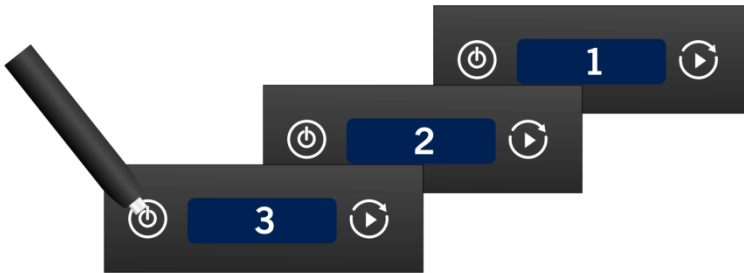

Fig. 6.3: Shut-off countdown.

X-zone Com turns off automatically if the battery's charge expires.

## 6.4 SCREEN DISPLAYS

The screen display has two distinct areas.

- Left: Status display for individual functions and actions.
- Right: Overall status display.



Fig. 6.4: X-zone Com's screen display.











### 6.4.1 Symbol overview

The following symbols describe the overall status.

Symbol	Meaning	Symbol	Meaning
	Currently no errors exist. Function test completed without discovering any problems.		Last action's status: X-zone Com device error detected.
	At least one action in progress (e.g. connecting to network, sending text message, determining position).		

The following table contains the definitions of the individual symbols.

Symbol	Meaning	Symbol	Meaning
	Data transmission to ORI Mcloud active! <b>Blinking:</b> Sending data.		

	E-mail send function active. At least one recipient. <b>Blinking:</b> Sending e-mail.		Sending of e-mail and transmission to Mcloud not possible / interrupted.
	Text message successfully transmitted / activated. <b>Blinking:</b> Sending text message.		Text message could not be sent.
	Battery completely charged <b>Battery charging progress shown using circular display:</b> Battery is charging.		Battery charge expended. Device may shut down unexpectedly.
	GPS successfully determined. <b>Blinking:</b> Determining coordinates.		No GPS (turned off or reception not possible)
	Signal strength approx. 100%		
	Signal strength approx. 20% <b>Blinking:</b> Registering in GSM network currently active.		Not connected to GSM network

**Example:**

1.		The battery has a 75% charge, signal strength is 100%, connection to Mcloud and e-mail-functions are enabled, GPS coordinates have been determined. Overall status is ok.
----	---	---



### 6.4.2 Error display

Various errors may appear in the display. Ch. 10.1 contains a table with explanations of the different errors and suggestions for remedying the situations. Press the right button to move from error to error.



Fig. 6.5: Example of an error message appearing in the display. It includes the number of the error and a brief description.

**Example:**

	Text messages and e-mail did not transmit during the function test. Transmission of data to Mcloud has not been enabled in this instance.
	<b>Possible reasons:</b> <ul style="list-style-type: none"> <li>• Invalid telephone number</li> <li>• Erroneous telephone number in "to" or "copy to"</li> </ul>
	

---

## 6.5 PERFORMING A FUNCTION TEST

---

The function test allows you to test the incoming and outgoing transmission, the functional capacity of X-zone Com, as well as GSM and GPS reception. In addition, the system begins immediately to determine the position coordinates.

The function test starts when you press the right control button  (for 3 seconds) on X-zone Com. The following actions take place:

- GPS enables, coordinates and time are ascertained.
- Modem logs into wireless network, APN connection established, IP address conveyed/ascertained.
- Sending of e-mail to registered addressee with all available, previously unsent data
- Transmitting of all unsent data to Mcloud, provided the Mcloud function is enabled
- Sending of a text message to every telephone number you entered in the system, provided you specified at least one alarm situation as a qualifier for the transmitting of a message

Status information will appear in the display (text message, e-mail and cloud, position). As long as an action has not been completed, the symbol will continue to blink.

Errors that occur will appear in the right portion of the display, indicated by their respective symbol. For further information about errors, refer to the "State" tab in the Manager Software (Ch. 5.4.6).



If text messages and email have successfully transmitted, the display on the left will appear.

You can return to the status viewer by pressing on the left button.

### NOTE



*During the function test, X-zone Com's left button has limited functionality, allowing you to turn off the device only.*



## 7 SENDING TEXT MESSAGES TO X-ZONE COM

X-zone Com offers users the convenience of responding to their queries or receiving their instructions via text message. Queries via text message require the following format:

[PIN] Command

The [PIN] (personal identification number) required is the same "Reader-PIN" specified in the Manager Software for just reading or the "Admin-PIN" for reading and further, effectual actions that will have an effect on the situation (see Ch.5.4.5). The PIN prevents X-zone Com from accepting text messages from unauthorised persons.

The entry of a wrong PIN will produce an error message directly on the device. In this instance, the system will not reply to a text message.



Fig. 7.1: Error message shown on the device in response to text message (SMS) containing an invalid PIN.

You may write the command using either upper or lower case letters. And you may also end the command with a question mark.

You'll find detailed explanations of the text message answers below.

PIN	Command	Answer
<b>[Read-PIN]</b>	Stat	Device information
	Group	Group information
	Local	Local readings from the X-zone 5x00 that is directly connected to X-zone Com
	Max	Maximum values of gasses measured in the closed network
	Alarm	Current alarm values
<b>[Execute-PIN]</b>	Ack	Alarm acknowledgement
	Evac	Evacuation alarm on
	Evac off	Evacuation alarm off
	GPS	Last known GPS coordinates

## 7.1 READER TEXT MESSAGES COMMANDS

Users can transmit read text message commands using a "Read-PIN" or with an "Execute-PIN".

SSSS

### 7.1.1 Status query

[PIN] stat

Contents of the text message reply	Value Ranges
X-zone Com device name	User-specified ASCII character succession
Status of connection to X-zone 5x00	"X-zone connected" "X-zone not connected"
GSM RSSI level [-dBm]	-100 to 0
X-zone Com battery voltage [V]	12 to 13.5 V (max 15V)
X-zone 5x00 battery voltage [V]	5 to 7 V
Use of e-mail alarms	ON/OFF
Frequency setting for e-mail and transmitting of data to Mcloud	5/10/15/30 min; 1/2/3/4/6/8/12 hrs;. 1 day

Example:

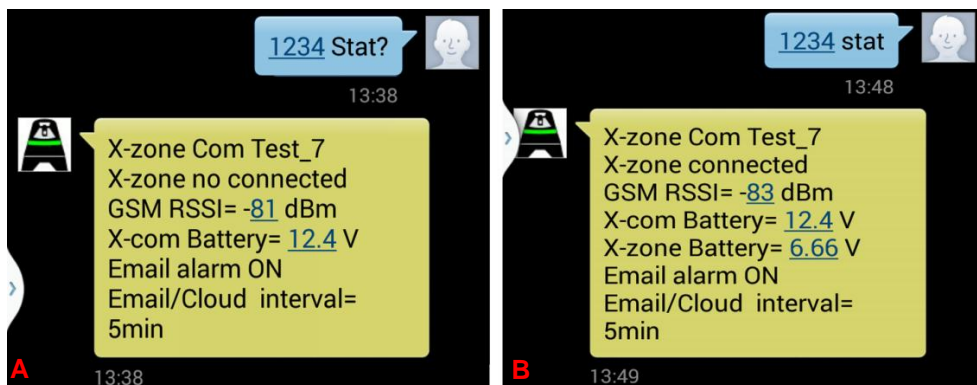

Fig. 7.2: Message displayed on a smart phone following text message query.

**A)** Answer received in the absence of a connection to X-zone 5x00.

**B)** Answer in the presence of connection to X-zone 5x00.

Use of upper and lower case is permitted.

## 7.1.2 Inquiring about group status

With the command "group" you can request information about a device group or a device not in a group in an open network.

### [PIN] group

Text Message Reply Content	Value Ranges
X-zone Com device name	User-specified ASCII character succession
Group status of the device	"Master device" "Group device" "Ungrouped"
Group size if connected to master device	2 to 15
Alarm situation	No alarm, A1, A2, device error
Number of monitored gasses (of the group or from local, connected X-zone 5x00)	0 to 8

**Example:** Answers for a group configuration

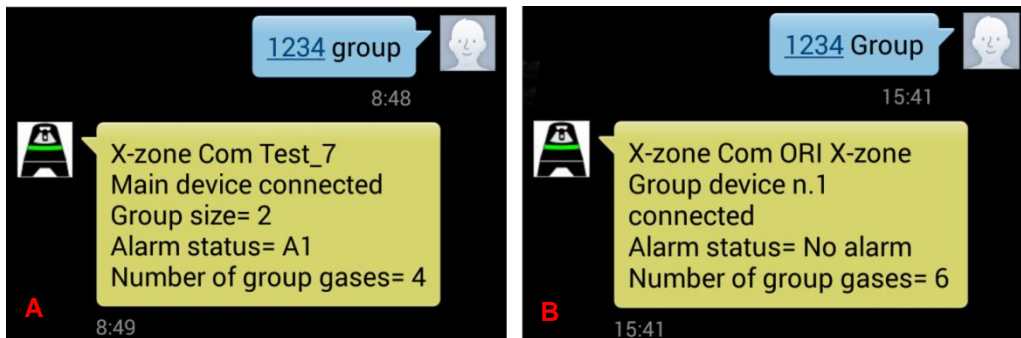

Fig. 7.3: Message displayed on a smart phone following group status query.

**A)** The device answering is a master device (ID=0). The group consists of 2 devices and monitors a total of 4 gasses. A A1 Alarm occurred.

**B)** The X-zone Com device is connected to the ID 1 group device. The group monitors a total of 6 gasses. No alarm has occurred.

**Example:** Answer from a local device

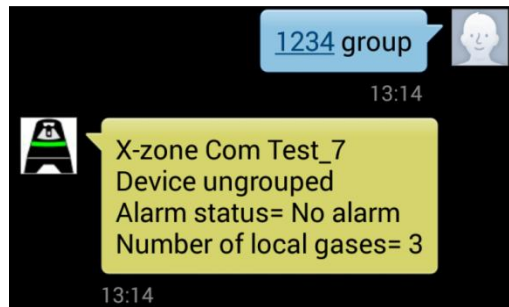

Fig. 7.4: The device answering is a non-group local device, which monitors 3 gasses.

### 7.1.3 Locally connected X-zone 5x00 readings

With the text message query "Local," you can obtain current readings from an X-zone 5x00 that is directly connected to X-zone Com, regardless of whether it belongs to a group.

#### [PIN] local

Text Message Reply Contents	Value Ranges
X-zone Com device name	User-specified ASCII character succession
Gas type	Abbreviated gas name of X-am 5x00
Concentration	0 to 10,000
Unit of measure	Vol%, %UEG, %LEL, %LIE, ppm, mg/m3, ppb, mbar, hPa, kPa, mg/L
Alarm type	A1, A2
Identification number	X-zone 5x00 serial number

**Example:**

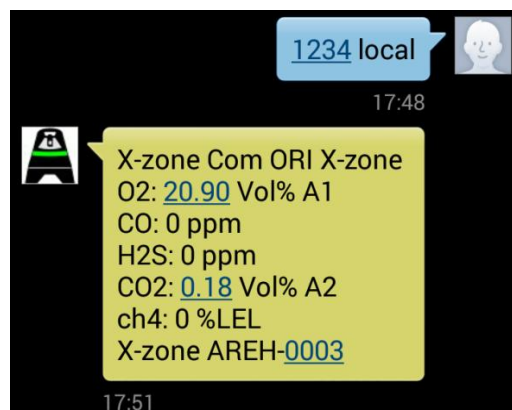

Fig. 7.5: Message displayed on a smart phone following sending of "1234 local." Here the X-zone "AREH-0003," which is connected with the X-zone Com "ORI X-zone," monitors 5 gasses. There are two alarms: A2 for CO<sub>2</sub> and A1 for O<sub>2</sub>.

### 7.1.4 Query for a group's maximum measured values

X-zone Com transmits a list that contains the maximum measure values of each gas monitored by the group, including types of alarms present and device IDs. In the instance of oxygen, the reading that appears in the list is the minimum value.

**[PIN] max**

Text Message Reply Contents	Value Ranges
X-zone Com device name	User-specified ASCII character succession
Gas type	Abbreviated gas name of X-am 5x00
Concentration	0 to 10,000
Unit of measure	Vol%, %UEG, %LEL, %LIE, ppm, mg/m3, ppb, mbar, hPa, kPa, mg/L
Alarm type	A1, A2
Identification number of the X-zone 5x00 with the maximum value in the group	0 to 15

**Example:** Maximum value

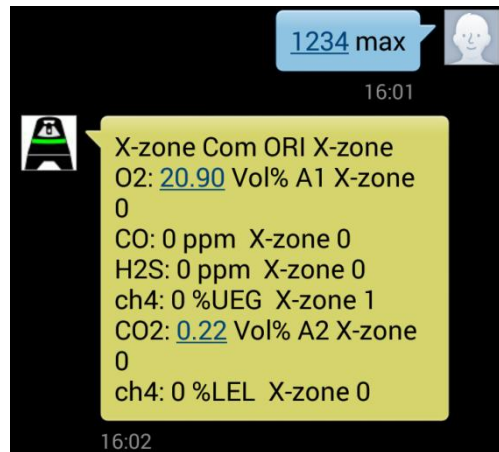

Fig. 7.6: Message displayed on a smart phone following a query to obtain the maximum values of all gases monitored in a group. In this example, the group device with ID 1 read the ch4 value. The master device with 0 ID measured the other gasses. For O<sub>2</sub> and CO<sub>2</sub> there is an A1, respectively an A2 Alarm.

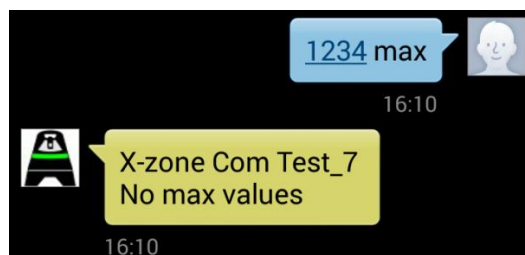

Fig. 7.7: Smart phone display if the connected X-zone 5x00 is not a group device. For such instances, use the "local" command.

## 7.1.5 Displaying GPS coordinates

The text message answer contains X-zone Com's last known position.

### [PIN] GPS

Text Message Reply Contents	Value Ranges
X-zone Com device name	User-specified ASCII character sequence
Coordinates	Latitude, longitude
Elevation	Approx. Elevation above sea level (Mean Sea Level)
Date and time of the last position reading	Date and time

The time displayed consists of "Universal Time Coordinated [UTC]" and the local time, e.g. Central European Time (CET):

- Normal: UTC+1
- Summer: UTC+2

Example:

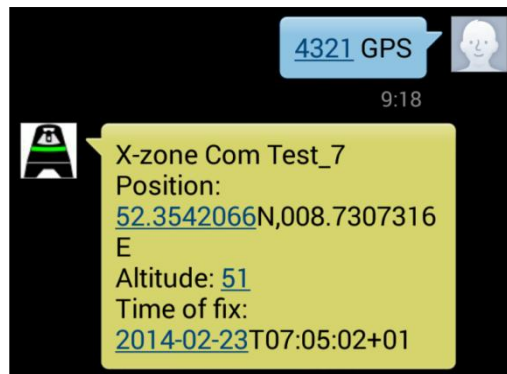

Fig. 7.8: Smart phone display following a query about position. Here the coordinates represent a reading last took at 08:05 local time (UTC+1). The text message query was at 09:18 local time.

## 7.1.6 Querying current alarms

It is possible to request a list of current alarms. The list may contain gas or device error alarms. A gas alarm transmits the following information: type of gas causing the alarm, current readings and unit of measure, as well as the X-zone 5x00 where the alarm occurred. In the event of a device error, the system communicates which X-zone 5x00 is experiencing the error, but does not provide an error code.

The information contained in the text message answer depends on your settings in the Manager Software.

Fig. 7.9: Specifying the information in the Manager Software you require in the text message reply to your queries.

### [PIN] Alarm

#### In the event of a gas alarm (A1, A2)

Text Message Reply Contents	Value Ranges
X-zone Com device name	User-specified ASCII character sequence
Character sequence	User-specified ASCII character sequence
Alarm type	A1, A2
Gas type	Abbreviated gas name of X-am 5x00
Concentration (optional)	0 to 10,000
Unit of measurement (optional)	Vol%, %UEG, %LEL, %LIE, ppm, mg/m3, ppb, mbar, hPa, kPa, mg/L
X-zone 5x00 ID (optional)	0 to 15 or X-zone 5x00 serial number

#### In the event of a X-zone 5x00 device error

Text Message Reply Contents	Value Ranges
X-zone Com device name	User-specified ASCII character sequence
Character sequence	User-specified ASCII character sequence
Alarm type	“Device alarm”
X-zone 5x00 ID (optional)	0 to 15 or X-zone 5x00 serial number

## Examples: Alarms

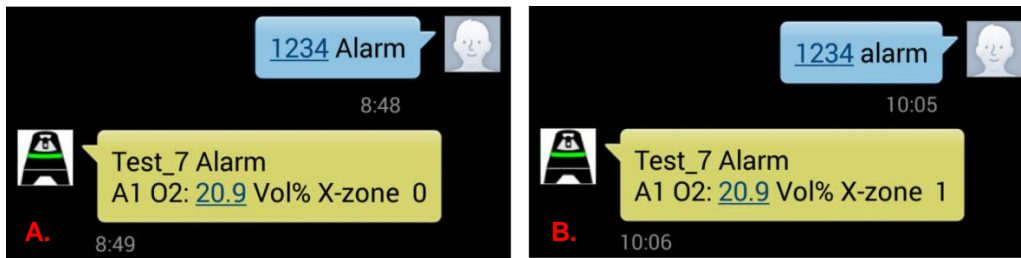



Fig. 7.10: Smart phone display following an alarm query addressed to X-zone Com "Test\_7." It indicates an A1 Alarm for oxygen. The oxygen reading that appears next to the alarm is the current O2 value, not the reading that caused the alarm.

The alarm originated

- A.** in this example, from "X-zone 0" (0=master)
- B.** in this example, from "X-zone 1" (1=group device).

NOTE	
	If the alarm has already been acknowledged, you will receive the message "All alarms stopped" when you send the PIN Alarm command.



## 7.2 EXECUTE TEXT MESSAGES COMMANDS

**NOTE**

 To use 'Execute' text message commands, you need the "Execute-PIN" in the Manager Software.

### 7.2.1 Alarm acknowledgement

How an X-am 5x00 reacts with an alarm acknowledgement depends on its configuration. Alarms may be acknowledgeable or unacknowledgeable and self-sustaining or non-self-sustaining. For this reason, you should read the user manual of your Dräger X-am 5x00 gas monitor carefully in its entirety.

**NOTE**

 Acknowledging an alarm does not necessarily mean the alarm will not reoccur. The system's reactions are subject to the specific alarm circumstances and the X-am 5x00's configuration.

The text message reply contains the X-zone Com's device name and also a message confirming the alarm's acknowledgement.

#### [Execute-PIN] ack

Text Message Reply Contents	Value Ranges
X-zone Com device name	User-specified ASCII character sequence
Acknowledgement text	"Alarms acknowledged"

#### Example:

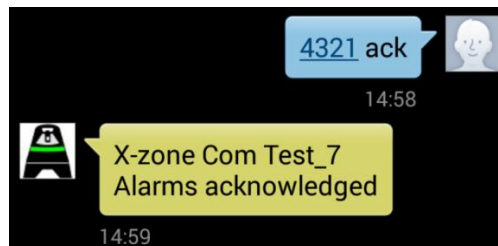

Fig. 7.11: Message appearing on a smart phone after an alarm has been acknowledged.

### 7.2.2 Enabling an evacuation alarm

Users can trigger with a text message alarms signaled by an X-zone 5x00 network as A2 Alarm. This is called an evacuation alarm because it is used to evacuate areas.

## [Execute-PIN] evac

Text Message Reply Contents	Value Ranges
X-zone Com device name	User-specified ASCII character sequence
Acknowledgement text	“Evacuation alarm”

Example:

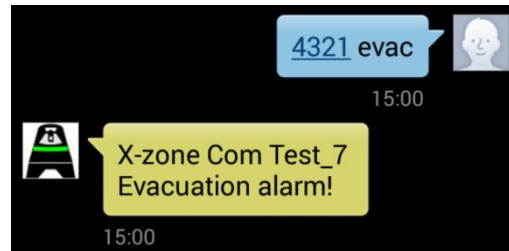



Fig. 7.12: Smart phone display after the triggering of an evacuation alarm.

**NOTE**

 An evacuation symbol appears on every X-am 5x00's display in a group if there is an evacuation alarm.

## 7.2.3 Resetting the evacuation alarm

You can reset the evacuation alarm by text message or by turning off the X-zone Com device.

### [Execute-PIN] evac off

Text Message Reply Contents	Value Ranges
X-zone Com device name	User-specified ASCII character sequence
Acknowledgement text t	“Evacuation alarm stopped”

Example:

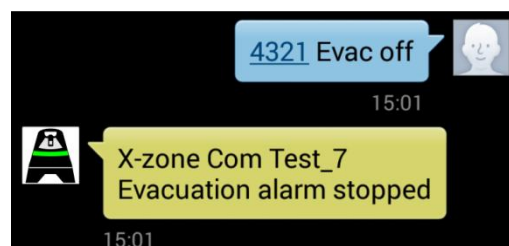

Fig. 7.13: Smartphone display after resetting the evacuation alarm.

## 8 Mcloud IN BRIEF

This chapter provides a general overview of ORI Mcloud's functions and use. For more in-depth information, you will want to consult the Mcloud manual.

Mcloud is an internet data portal that allows you, with the use of your web browser, to view and obtain information from your X-zone Com devices. Along with the general device status, battery capacity level and time of the last data transmission, it allows you to monitor all the detection, metering and alarm activities and readings. Operators can determine when the monitoring is active and its duration to suit their specific requirements. Data appears in graphic displays and exports in a CSV file format allowing you to download it to your computer, where the files open and process with Microsoft Excel. In addition, you have the convenience of plotting all your X-zone Com devices on a map.

To access Mcloud, you require internet access, a web browser, and, after a 4-week trial period, a license for each device. The 4-week trial begins as soon as you register the device. When it expires, you may purchase licenses that are valid for a specified time. With a valid X-zone Com license, you can save as many readings as you require. A warning symbol will appear in the device lists notifying you sufficiently in advance of license expiration.

Your X-zone Com data will be stored in Germany on a server that has been tested by TÜV and found to be compliant with "Trusted Site TSI V3.0 Level 1" standards. Access via browser requires a password and uses secure Hypertext Transfer Protocol (HTTPS).



### 8.1 Mcloud DEVICE LIST

The device list contains all your registered devices. If one of your devices does not appear in the list, you'll need to register it with Mcloud (see Fig. 8.2). Registration is only possible if the device had transmitted data at least once. To send readings to Mcloud, you have to first activate the Cloud functions with the assistance of the Manager Software (see Ch. 5.4.4).

The screenshot shows the Mcloud web interface. At the top left is the logo with the text 'Mcloud ori'. At the top right are flags for the UK, China, and Germany, followed by links for '[My account]' and '[Logout]', and the email address 'info@origmbh.de'. Below the header is a navigation bar with links for 'Home', 'List of devices', 'Map', and 'All measured values'. The main content area is titled 'REGISTER DEVICE' and contains the following text: 'In order for your device data can be stored in Mcloud, you must register the device. Please fill out the following form and click 'Register'. The registration is only possible if your device has previously sent data at least once.' The form itself has a title 'Register device' and three input fields: 'Device-ID (Hex-Format):', 'Device-name (the same with location):', and a dropdown menu currently set to 'Xcom'. A 'Register' button is positioned at the bottom right of the form.

Fig. 8.1: Request to register your device in order to use Mcloud.

For each registered X-zone Com, you will see:

- **1** The device ID
- **2** Site where readings were taken (device name given by user with Manager Software assistance)
- **3** Last time device transmitted
- **4** Transmission status  = currently active;  = inactive for a long while (over 24 hrs.)

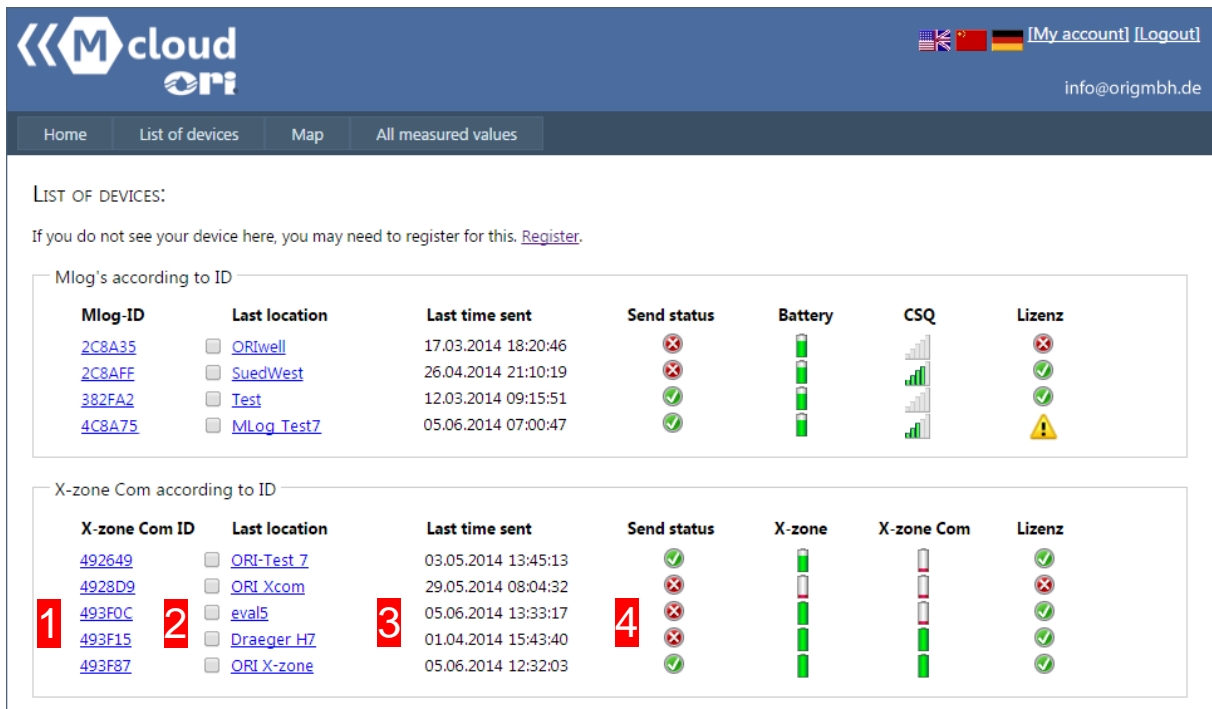

Home List of devices Map All measured values

cloud OPI [My account] [Logout] info@origmbh.de

LIST OF DEVICES:  
If you do not see your device here, you may need to register for this. [Register](#).

Mlog's according to ID

Mlog-ID	Last location	Last time sent	Send status	Battery	CSQ	Lizenz
<a href="#">2C8A35</a>	<input type="checkbox"/> <a href="#">ORiwell</a>	17.03.2014 18:20:46				
<a href="#">2C8AFF</a>	<input type="checkbox"/> <a href="#">SuedWest</a>	26.04.2014 21:10:19				
<a href="#">382FA2</a>	<input type="checkbox"/> <a href="#">Test</a>	12.03.2014 09:15:51				
<a href="#">4C8A75</a>	<input type="checkbox"/> <a href="#">MLog_Test7</a>	05.06.2014 07:00:47				

X-zone Com according to ID

X-zone Com ID	Last location	Last time sent	Send status	X-zone	X-zone Com	Lizenz
<a href="#">492649</a>	<input type="checkbox"/> <a href="#">ORI-Test 7</a>	03.05.2014 13:45:13				
<a href="#">4928D9</a>	<input type="checkbox"/> <a href="#">ORI Xcom</a>	29.05.2014 08:04:32				
<b>1</b> <a href="#">493F0C</a>	<input type="checkbox"/> <a href="#">eval5</a>	<b>3</b> 05.06.2014 13:33:17	<b>4</b>			
<a href="#">493F15</a>	<input type="checkbox"/> <a href="#">Draeger H7</a>	01.04.2014 15:43:40				
<a href="#">493F87</a>	<input type="checkbox"/> <a href="#">ORI X-zone</a>	05.06.2014 12:32:03				

Fig. 8.2: List of all the registered devices and link to registration.

Symbols display specific information for the different devices in the other columns, for X-zone Com, e.g. it displays its battery capacity and the battery capacity of any directly connected X-zone 5x00s.

Battery capacity (%)	CSQ (%) signal strength	License status
approx. 75-100%	approx. 100%	License valid
approx. 50-75%	approx. 80%	License expires soon
approx. 30-50%	approx. 60%	License has expired
approx. 15-30%	approx. 40%	
< 15%	approx. 20%	
	no signal	

## 8.2 M-CLOUD DEVICE STATUS

Click on the device ID **(1)** to obtain detailed information about the device. For safety purposes, you can enable the system to monitor the transmission frequency. To proceed, enter the transmission cycle (in minutes) specified in the Software Manager, using "Monitoring time transmission interval." Now the system will monitor whether the device transmits to the cloud in the specified intervals. If it fails to do so, the system will trigger an alarm.

**Mcloud ori** [My account] [Logout] info@origmbh.de

Home List of devices Map All measured values

**X-ZONE COM**

Here you can see the current status and parameter values of the last episode of your X-zone Com. In addition, you can also renew the license of your X-zone here.

**ORI X-zone**

X-zone Com location: ORI X-zone	Created on: 07.04.2014 18:20:14	Last measured value: 05.06.2014 12:31:58	Alarm X-zone: Ok	Battery X-zone: 6,609
X-zone Com ID: 493F87 (4800391)	Last time sent: 05.06.2014 12:32:03	Local timezone: 02:00:00	Alarm Net: Ok	Battery X-zone Com: 14,136

**GPS**

Time: 20/05/2014 17:31:34	Time zone: 02:00:00	Longitude: 8.730717	Latitude: 52.35361	Altitude: 0
------------------------------	------------------------	------------------------	-----------------------	----------------

**Parameter**

Monitoring time transmission interval [min]:  Enter 0 to switch off the monitoring.

**Licence**

X-zone Com license expiration date:  New Licence number:

Fig. 8.3: Click on the device ID and the system displays the device's status. At the time of transmission, it was summer time in Germany, which is why a local time of 02:00:00 (UTC+2 – see Ch. 7.1.5) appears.

If the system fails to transmit as specified, you will receive an alarm via e-mail and the device symbol will turn red. Upon acknowledgement of the alarm, the device symbol changes from red to green on the map. Click on the menu item [Map] in the main menu bar to change to the map view.

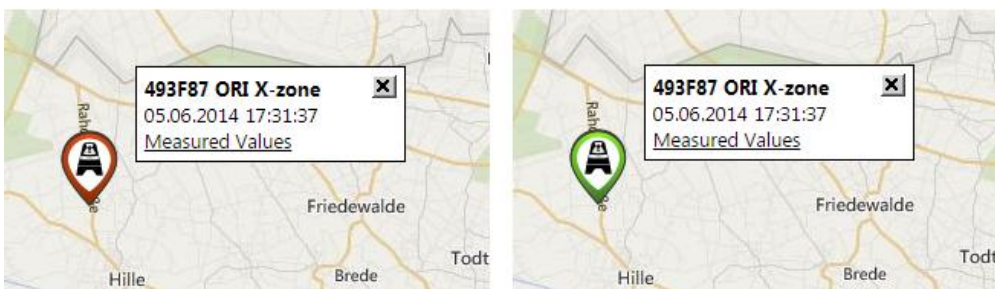

Fig. 8.4: The device symbol on the map changes from red to green when you acknowledge a transmission interval alarm.

## 8.3 MCLLOUD MEASUREMENT VALUES

Click on last reading site (2) to view a device's current readings. You can mark the individual sensors and view a graph of their readings for a specific period of time or export them in a CSV file.

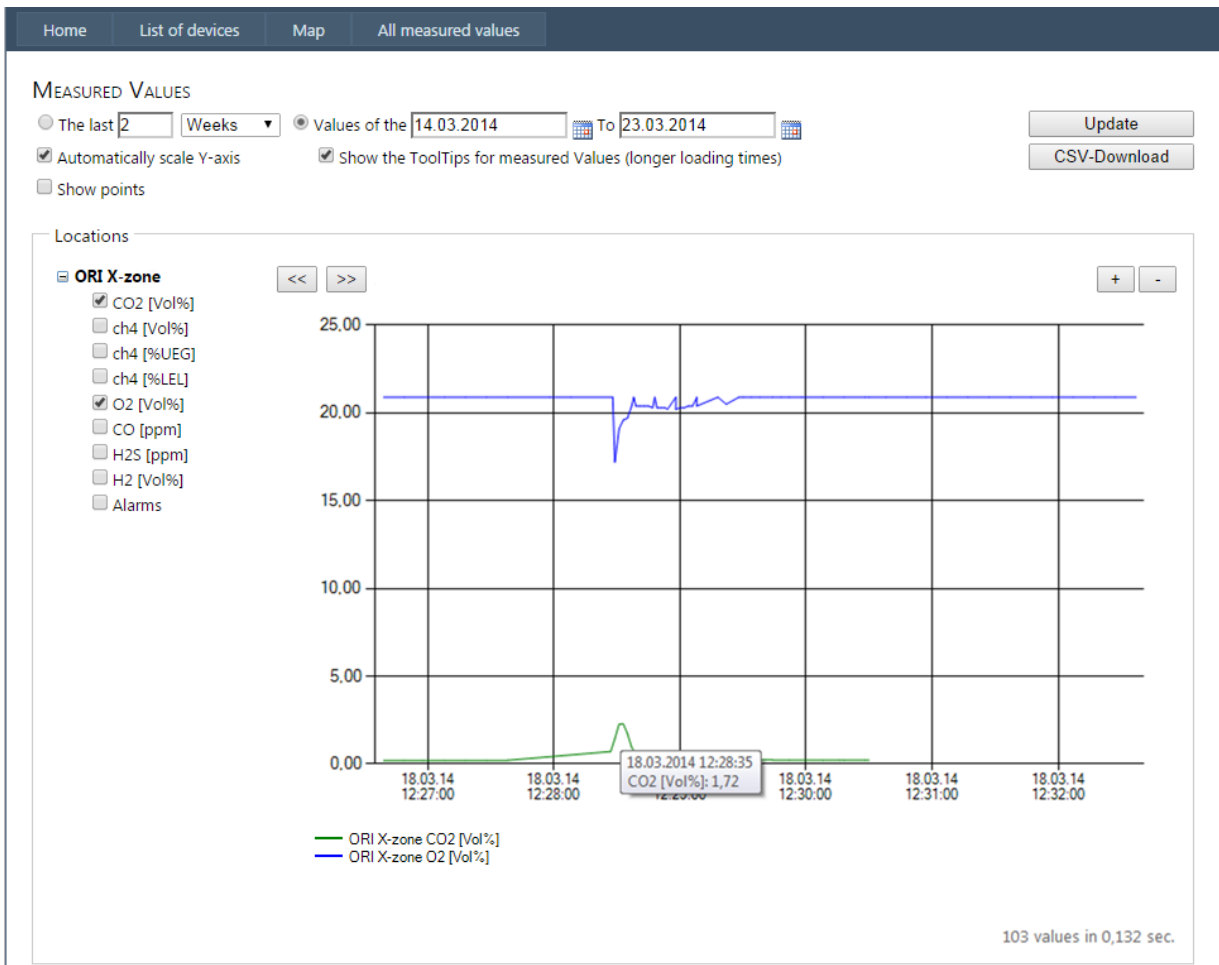

Fig. 8.5: An enlarged graph of X-zone Com Test\_7's two gas sensors.

You can display the data of multiple devices by marking and then clicking the checkboxes of the monitoring sites. Or you can click [All Measurements] in the menu bar to select all the devices with their respective sensors.

### NOTE







It is possible to view multiple data series of devices with different IDs simultaneously on a graph or export them. In addition, you can view readings from the different monitoring sites of a device with different sensors.



## 8.4 M-CLOUD MAP PLOTTING

Click [Map] in the main menu bar to plot the positions of all the registered devices (you can choose between map, bird's eye or automatic view).

Display Device Symbols	
	X-zone Com
	Camera
	Mlog
	waste water sampler

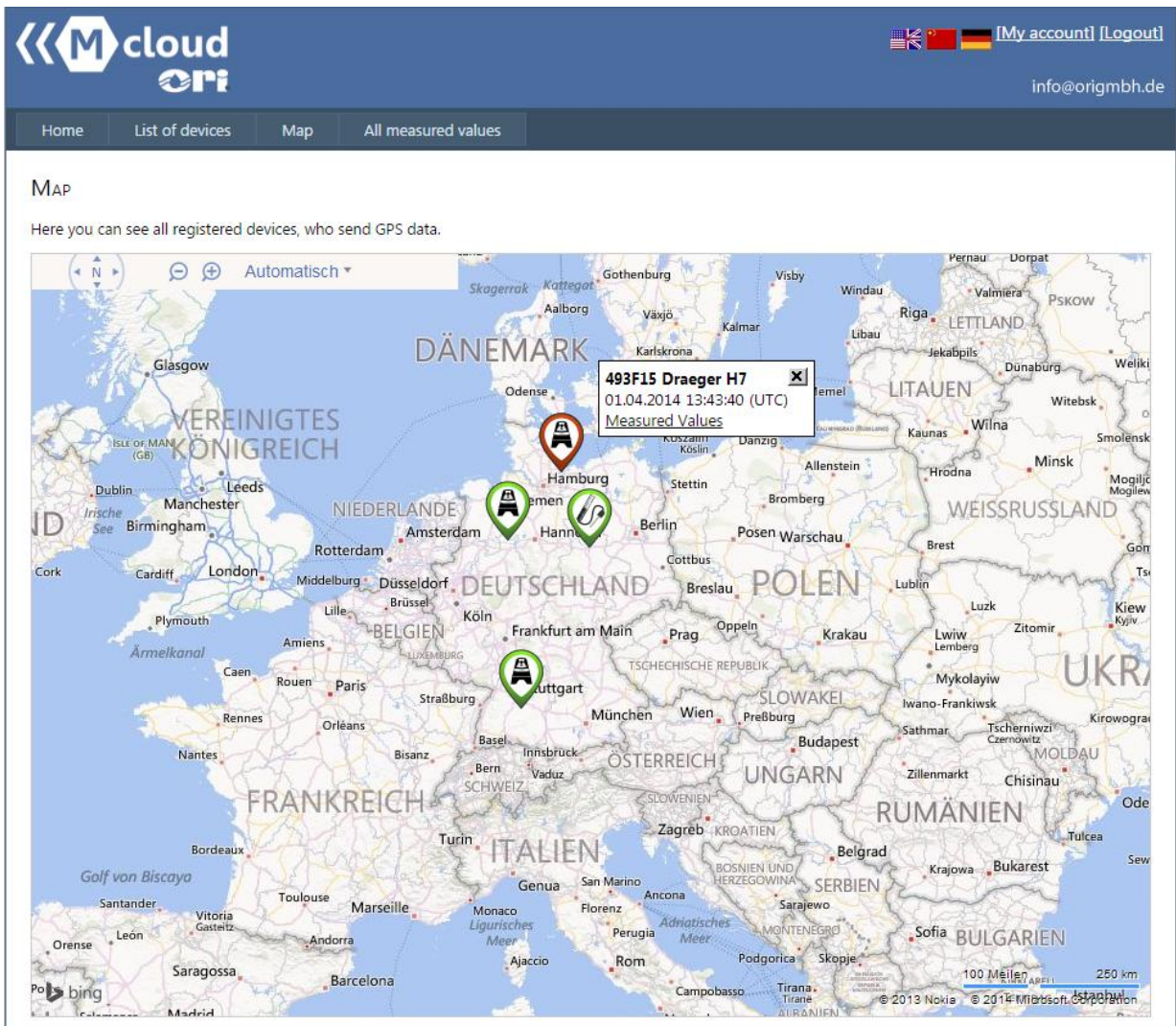

Fig. 8.6: All your registered devices appear on a single map.

If you pass over a device symbol with the mouse, a miniature window will appear to the right of the symbol. It contains the device ID, device name, time of last data transmission and a link to the readings.

You can zoom in and out on the map using either the magnifying glass symbol or your mouse wheel.

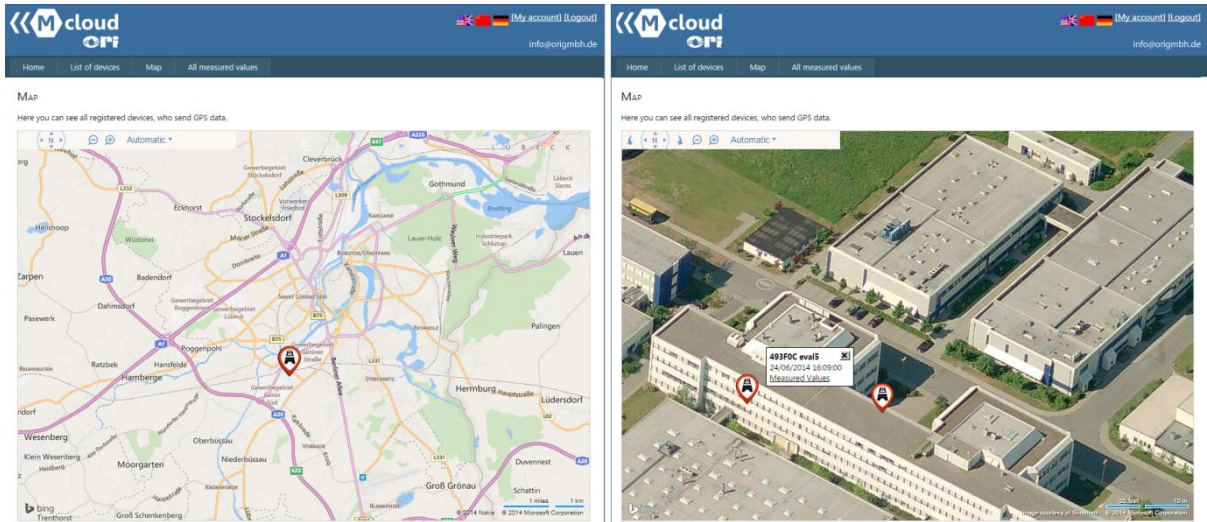

Fig. 8.7: Plotting of all registered devices. As you zoom in, your view changes automatically to a bird's eye perspective. Of the two devices shown here, the two indicated by the red symbol has not transmitted any data to Mcloud for a long time.



## 9 MAINTENANCE AND CARE

### 9.1 FREQUENCY

**X-zone Com:** It is necessary to have this device inspected and serviced regularly by qualified technicians.

**Charger:** The charger does not require any special maintenance. The manufacturer or a service technician authorised by the manufacturer should perform any service required on the charger.

### 9.2 CLEANING

Clean the device only with a moist cloth.

#### NOTE



**Never use cleaning solutions that contain alcohol.**

### 9.3 REMOVING THE BATTERY FOR REPAIR

#### WARNING



##### **Explosion hazard!**

*Do not open the battery compartment if it is in an ex atmosphere. The battery belongs to the device's certification and the connecting and disconnecting of the battery should only take place in an area that is not threatened by explosion.*

#### CAUTION



##### **Damage may occur!**

*If you open the housing, make sure to hold X-zone Com's upper section securely so that you don't drop the battery and the upper section, causing damage to them.*

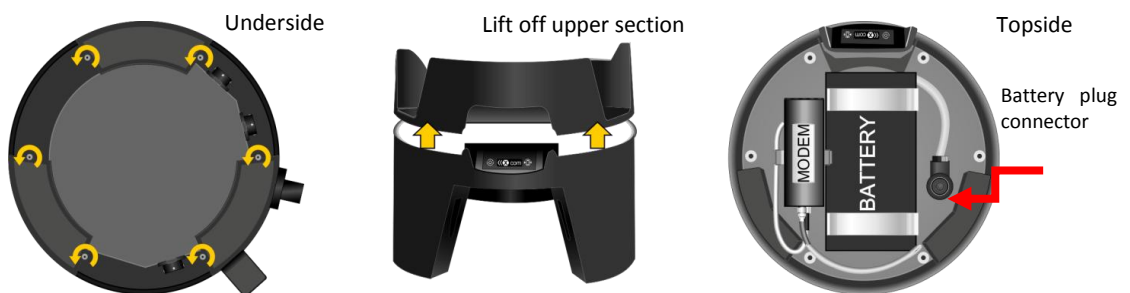

Fig. 9.1: Opening the battery compartment.

*Loosen the 6 screws on the housing's underside.*

*Lift off the upper section.*

*Detach the battery plug, loosen the holder and remove the battery.*

To reassemble the X-zone Com, reverse the disassembly procedure. Tighten the screws so they are hand-tight.

# 10 APPENDIX

## 10.1 ERROR CODES

Error Codes	Display Message (X-zone Com)	Description.	Remedy
<b>Device error</b>			
1	Check sum error	Memory test error - Configuration memory	Contact ORI Service.
2	Check sum error	Memory test error – data memory	Contact ORI Service.
3	Internal HW error	<i>Real time clock</i> doesn't run	Contact ORI Service.
6	Internal HW error	<i>RS485 bridge</i> doesn't work	Contact ORI Service.
<b>Battery error</b>			
9	Battery HW error	Communication error with battery controller	Contact ORI Service. (Battery internally connected?)
10	Battery main alarm	Main alarm battery	Contact ORI Service.
11	Battery pre-alarm	Prealarm battery	Charge X-zone Com.
12	Battery empty	Battery completely spent	Charge X-zone Com.
14	Battery too cold	Battery temperature too low	Stop charging and move X-zone Com to a warmer area.
15	Charging error	Battery error	Batter error - Contact ORI Service.
<b>GPS error</b>			
16	GPS HW error	GPS module not functioning	Contact ORI Service.
17	GPS error	Unspecific GPS error	Contact ORI Service.
<b>GSM error</b>			
20	GSM modem error	GSM modem not working	Modem connected internally?
21	No SIM card	No SIM card	Insert SIM card.
22	SIM not working	SIM not working	Insert new SIM card.
23	SIM: Wrong PIN	SIM card: wrong PIN	Use Manager Software to configure PIN properly.
24	SIM blocked	SIM card blocked: enter PUK	Insert the SIM card in a mobile phone and unblock the card by entering the PUK ( <i>Personal Unblocking Key</i> ).
25	Roaming error	<i>Roaming</i> not allowed	Use a suitable SIM card.
26	GSM error	GSM – unknown error	Check and configure the GSM/GPRS settings by means of the Manager Software (see Ch. 5.4.3).
27	No GSM network	No GSM network found	Change device position and check: <ul style="list-style-type: none"> <li>• Signal strength (see Ch. 5.4.3)</li> <li>• Antenna</li> <li>• Validity of SIM card and credit balance</li> </ul>
28	Wrong APN login	GPRS authentication error: wrong APN	Use the Manager Software to check the accuracy of the following: <ul style="list-style-type: none"> <li>• APN of your mobile phone provider</li> <li>• User name</li> <li>• Password</li> </ul>
29	GPRS error	GPRS – unknown error	Check and configure the GSM/GPRS settings by means of the Manager Software (see Ch. 5.4.3).
30	IP error	No IP address received	Check and configure the GSM/GPRS settings by means of the Manager Software (see Ch. 5.4.3).
31	Unknown mail server	<i>Mail host name</i> is unknown/unassigned	Enter a valid e-mail server name.
<b>Text message error</b>			
40	Unknown phone no.	Unknown phone number	Configure by means of Manager Software.
41	Text message error	Unknown text message error	Configure by means of Manager Software.
42	Text message not sent	Text message unable to send	Check: <ul style="list-style-type: none"> <li>• Text message settings using Manager Software.</li> <li>• If prepaid card, credit balance</li> </ul>
43	Wrong PIN in text messages	Text message with wrong PIN received	Set and enable using Manager Software the "Reader-" and "Admin-PIN" and use them to send

			a text message to X-zone Com (see Ch. 5.4.5)
47	Unknown email user	Unknown e-mail user	Check via Manager Software: <ul style="list-style-type: none"> <li>• User name</li> <li>• Password</li> </ul>
48	Mailbox full	E-mail box full	Check your e-mail box
49	E-mail rejected	E-mail rejected	Check your e-mail settings via Manager Software
50	E-mail not sent	E-mail unable to send	Check via Manager Software: <ul style="list-style-type: none"> <li>• Signal strength (see Ch. 5.4.3)</li> <li>• E-mail settings</li> </ul>
<b>System error</b>			
85	No time set	No date and time settings	Set date and time using Manager Software (see Ch. 5.4.1)
86	Incompatible SW	Modbus – communication error with X-zone 5x00	Update X-zone 5x00 and X-zone Com software.
89	X-zone missing	X-zone 5x00 disconnected from X-zone Com	Check: <ul style="list-style-type: none"> <li>• Connection to X-zone 5x00.</li> <li>• Modbus X-zone 5x00 settings (115200, E, 8,1)</li> </ul>

## 10.2 ORDER LIST

Description	ORI Order No.	Dräger Order No.
<b>X-zone Com Set</b> –  II 2G Ex ib [ia IIC Ga] [ib IIC] IIB T3/T4 Gb Communication unit for Dräger X-zone 5x00	8094 100	8324383
<b>Charger/Power supply unit:</b>		
Charger	8094 114	8324374
Power cable Europe	8094 142	8325391
Power cable Great Britain	8094 141	8325392
Power cable Australia	8094 140	8325393
<b>Battery pack</b>	8094 106	8324376
<b>Connecting cable:</b>		
RS232 for X-zone Com / PC	8094 120	8324379
RS 485 for X-zone Com / X-zone	8094 118	8324373
<b>Software</b>		
Manager Software for setting X-zone Com	5415 045-2	
12-month Mcloud license	5415 061	8325346
36-month Mcloud license	5415 063	8325347
<b>Replacement parts:</b>		
Fastening set (for secure mechanical connection between X-zone and X-zone Com by means of a strap)	8094 117	
Fastening strap set	8094 136	8324377
Base for X-zone Com with holder	8094 135	8324384
<b>Replacement parts:</b>		
GSM-GPRS modem	5415 029	8324375
Battery/rechargeable battery	8094 106	8324376
GSM antenna X-zone Com	8094 108	8324372

## 10.3 FIRMWARE UPDATING

To update X-zone Com's firmware, you need a connection between X-zone Com and a computer via Bluetooth or RS232 connecting cable. In addition, you require the "FirmLoader.exe" software and a current "XCOM VX\_XXX.fmw" firmware file. You can obtain these from your ORI or Dräger service representative. Before you begin, determine your connection's COM-Port number if you do not already know it (see Ch. 5.1). Then continue as described in the following:

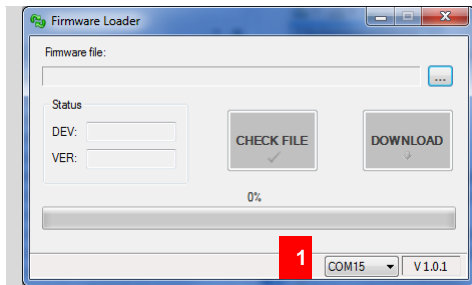

1 Start the "FirmLoader.exe" and select your COM-Port.

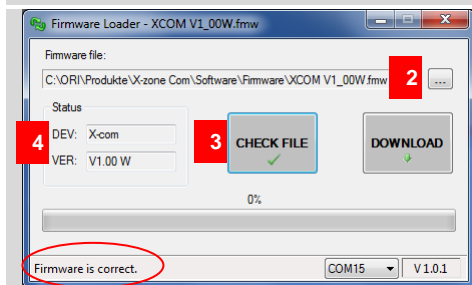

2 Select the most current firmware file.

3 Click [CHECK FILE] to check the suitability of the firmware you selected.

4 Your device type and the version number of your selected firmware will appear in the "DEV" and "VER" boxes.

The status line at the bottom left of the window displays the results of your actions.

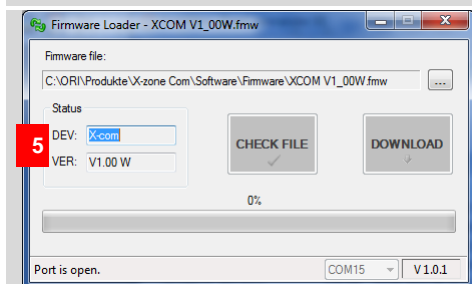

5 Make sure the firmware is one for a X-zone Com.

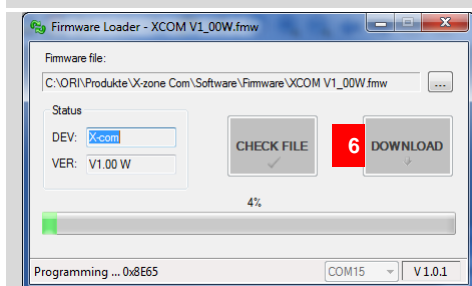

6 Click [DOWNLOAD] to download the firmware to your X-zone Com.

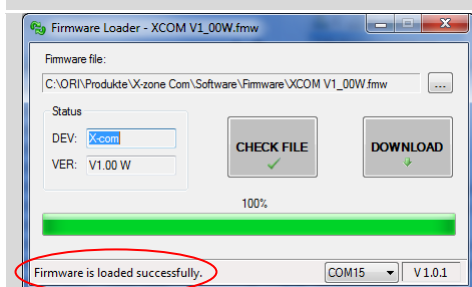

The status line will inform you when and if the download has been completed.

Close the firmware loader with a click on  in the right corner of the window.

**NOTE**



*If an X-zone 5X00 is connected during the DOWNLOAD, a device alarm will occur.*

If your attempt to update was unsuccessful, check all your connections. Make sure, if you're using Bluetooth, the computer detects your X-zone. In addition, be sure the distance between both devices is not too great or objects between the devices are not hindering communications. Check the COM-Port number to ensure it is correct.

Begin the update again.

## 10.4 CERTIFICATES

	<h1>IECEX Certificate of Conformity</h1>	
<b>INTERNATIONAL ELECTROTECHNICAL COMMISSION</b> <b>IEC Certification Scheme for Explosive Atmospheres</b> for rules and details of the IECEx Scheme visit <a href="http://www.iecex.com">www.iecex.com</a>		
Certificate No.:	<input type="text" value="IECEX FTZU 14.0013X"/>	issue No.: <input type="text" value="0"/>
Status:	<input type="text" value="Current"/>	
Date of Issue:	<input type="text" value="2014-06-13"/>	Page 1 of 3
Applicant:	<b>ORI-Abwassertechnik GmbH &amp; Co. KG</b> Bollacken 2, 32479 Hille Germany	
Electrical Apparatus: <i>Optional accessory:</i>	Communication Equipment Device COM	
Type of Protection:	Intrinsic safety	
Marking:	Ex ib [ia IIC Ga] [ib IIC] IIB T3/T4 Gb	
<i>Approved for issue on behalf of the IECEx Certification Body:</i>	Dipl. Ing. Lukáš Martinák	
<i>Position:</i>	Head of the Certification Body	
<ol style="list-style-type: none"><li>1. This certificate and schedule may only be reproduced in full.</li><li>2. This certificate is not transferable and remains the property of the issuing body.</li><li>3. The Status and authenticity of this certificate may be verified by visiting the Official IECEx Website.</li></ol>		
Certificate issued by:		



Physical Technical Testing Institute  
Ostrava – Radvanice



## EC-Type Examination Certificate

- (1)  
(2) **Equipment or Protective Systems Intended for Use  
in Potentially Explosive Atmospheres  
(Directive 94/9/EC)**

(3) EC-Type Examination Certificate Number:

**FTZÚ 14 ATEX 0048X**

- (4) Equipment or protective system: **Communication Equipment Device.COM**  
(5) Manufacturer: **ORI Abwassertechnik GmbH & Co. KG**  
(6) Address: **Bollacken 2, D-32479 Hille, Germany**  
(7) This equipment or protective system and any of acceptable variation thereto is specified in the schedule to this certificate and the documents therein referred to.  
(8) The Physical Technical Testing Institute, notified body number 1026 in accordance with Article 9 of the Council Directive 94/9/EC of 23 March 1994, certifies that this equipment or protective system has been found to comply with the Essential Health and Safety Requirements relating to the design and construction of equipment and protective systems intended for use in potentially explosive atmospheres given in Annex II to the Directive.

The examination and test results are recorded in confidential Report N°:

**14/0048 dated 13.06.2014**

- (9) Compliance with Essential Health and Safety Requirements has been assured by compliance with:  
**EN 60079-0:2012, EN 60079-11:2012, EN 60079-26:2007**  
(10) If the sign "X" is placed after the certificate number, it indicates that the equipment or protective system is subject to special conditions for safe use specified in the schedule to this certificate.  
(11) This EC-Type Examination Certificate relates only to the design, examination and testing of the specified equipment or protective system in accordance to the directive 94/9/EC. Further requirements of the Directive apply to the manufacturing process and supply of this equipment or protective system. These are not covered by this certificate.  
(12) The marking of the equipment or protective system shall include following:



**II 2G Ex ib [ia IIC Ga] [ib IIC] IIB T3/T4 Gb**

This EC-Type Examination Certificate is valid till: **13.06.2019**

Responsible person:

  
Dipl. Ing. Lukáš Martinák  
Head of Certification Body



Date of issue: 13.06.2014

Page: 1/4

This certificate is granted subject to the general conditions of the FTZÚ, s.p.  
This certificate may only be reproduced in its entirety and without any change, schedule included.

FTZÚ, s.p., Pikartská 1337/7, 716 07 Ostrava-Radvanice, Czech Republic,  
tel +420 595 223 111, fax +420 596 232 672, ftzu@ftzu.cz, www.ftzu.cz





Physical Technical Testing Institute  
Ostrava – Radvanice



## Supplement No. 1 to EC-Type Examination Certificate

(1)  
(2) **Equipment or Protective Systems Intended for Use  
in Potentially Explosive Atmospheres  
(Directive 94/9/EC)**

(3) EC-Type Examination Certificate Number:

**FTZÚ 14 ATEX 0048X**

(4) Equipment or protective system: **Communication Equipment Device.COM**

(5) Manufacturer: **ORI Abwassertechnik GmbH & Co. KG**

(6) Address: **Bollacken 2, D-32479 Hille, Germany**

(7) This supplement of certificate is valid for: - modification of certified apparatus  
- modification of apparatus marking  
- new model (variant) external power supply **02617PS**

(8) Modification of certified apparatus (protective system) and any of its approved variants are specified in documentation, list of which is mentioned in schedule of this certificate.

(9) This supplement to type examination certificate is valid only for type examination of design and construction of product sample in accordance with Annex 3 Paragraph 6) of Directive No. 94/9/EC. The Directive contains another requirements, which manufacturer shall fulfil before products are placed on market or introduced in service.

(10) Safety requirements of modified parts were fulfilled by satisfying the following standards:

**EN 60079-0:2012, EN 60079-11:2012, EN 60079-26:2007**

(11) Marking of equipment shall contain symbols:

 **II 2G Ex ib [ia IIC Ga] [ib IIC] IIB T3/T4 Gb**

 **II (2)G [Ex ib Gb] IIB** zdroj 02617PS

(12) This type examination certificate is valid till: **13.06.2019**

Responsible person:

  
Dipl. Ing. Lukáš Martinák  
Head of Certification Body



Date of issue: **20.10.2014**

Page: 1/3

This supplement to certificate is granted subject to the general conditions of the FTZÚ, s.p.  
This supplement to certificate may only be reproduced in its entirety and without any change, schedule included.

FTZÚ, s.p., Pikartská 1337/7, 716 07 Ostrava-Radvanice, Czech Republic,  
tel +420 595 223 111, fax +420 596 232 672, ftzu@ftzu.cz, www.ftzu.cz



# X-zone COM

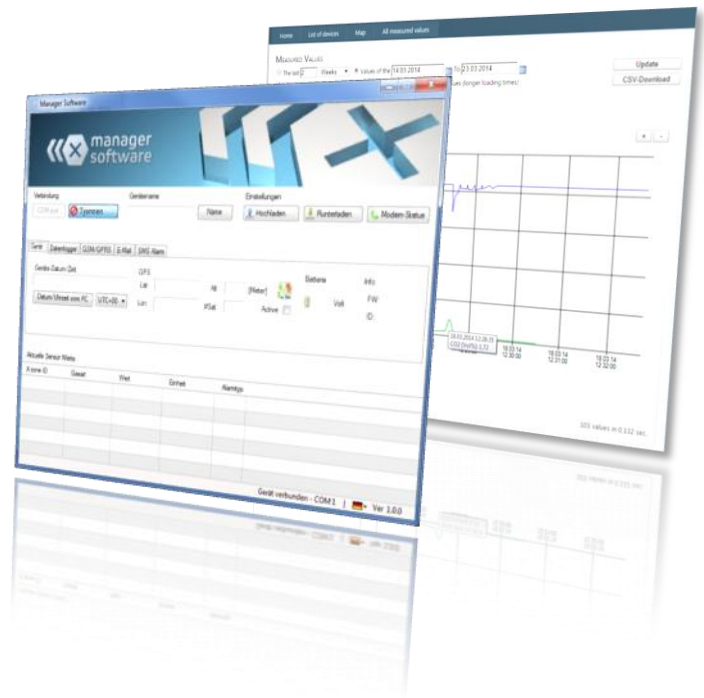

X-zone Com  II 2G Ex ib [ia IIC Ga] [ib IIC] IIB T3/T4 Gb  
Type: 02617

## Gebrauchsanleitung

Rev20141015-01

Art.-Nr. 8094130

---

## Übersetzung

Sollten im übersetzten Text Unstimmigkeiten auftreten, ist die Original-Gebrauchsanleitung (deutsch) zur Klärung heranzuziehen oder der Hersteller zu kontaktieren.

## Copyright

Weitergabe sowie Vervielfältigung dieses Dokuments, Verwertung und Mitteilung seines Inhalts sind verboten, soweit nicht ausdrücklich gestattet. Zuwiderhandlungen verpflichten zu Schadenersatz. Alle Rechte vorbehalten.

## Gebrauchsnamen

Die Wiedergabe von Gebrauchsnamen, Handelsnamen, Warenbezeichnungen und dergleichen in dieser Gebrauchsanleitung berechtigen nicht zu der Annahme, dass solche Namen ohne Weiteres von jedermann benutzt werden dürften; oft handelt es sich um gesetzlich geschützte eingetragene Warenzeichen, auch wenn sie nicht als solche gekennzeichnet sind.

## Zulassung:

Dieses Dokument ersetzt nicht die Technische Dokumentation der gültigen Zertifikate. Fordern Sie im Bedarfsfall diese Technische Dokumentation bei ORI GmbH & Co.KG separat an.

## Einsatz in explosionsgefährdeten Bereichen

Geräte oder Bauteile, die in explosionsgefährdeten Bereichen genutzt werden und nach nationalen, europäischen oder internationalen Explosionsschutzrichtlinien geprüft und zugelassen sind, dürfen ausschließlich unter den in der Zulassung angegebenen Bedingungen und unter Beachtung der relevanten gesetzlichen Bestimmungen eingesetzt werden. **Änderungen dürfen an den Betriebsmitteln, Geräten oder Bauteilen nicht vorgenommen werden. Der Einsatz von defekten oder unvollständigen Teilen ist unzulässig.** Bei Instandsetzung an diesem Gerät oder Bauteilen müssen die entsprechenden Bestimmungen beachtet werden.

Das Gerät muss regelmäßigen Inspektionen und Wartungen durch Fachleute unterzogen werden.



**Vor Inbetriebnahme  
sorgfältig lesen!**

---

(X-zone Com Seriennummer bitte hier eintragen)

# INHALTSVERZEICHNIS

<b>1</b>	<b>Allgemeines .....</b>	<b>5</b>
1.1	Funktionsbeschreibung.....	5
1.2	Bestimmungsgemäße Verwendung .....	5
1.3	Lagerung und Rücksendung.....	6
1.4	Entsorgung.....	6
<b>2</b>	<b>Sicherheitshinweise .....</b>	<b>7</b>
2.1	Sicherheitszeichen und Symbole .....	7
2.2	Sicherheitsanweisungen.....	8
2.3	Betriebssicherheit .....	8
<b>3</b>	<b>Aufbau und technische Daten .....</b>	<b>9</b>
3.1	Abmessungen.....	9
3.1.1	X-zone Com + X-zone 5x00 .....	9
3.1.2	Ladegerät I.S. Power supply 02617PS.....	10
3.2	Schnittstellen X-zone Com und Ladegerät .....	10
3.2.1	X-zone Com.....	10
3.2.2	Ladegerät I.S. Power supply 02617PS.....	12
3.3	Kennzeichnung .....	13
3.4	Gerätespezifikationen .....	14
3.4.1	X-zone Com.....	14
3.4.2	Ladegerät.....	15
<b>4</b>	<b>Montage und Inbetriebnahme.....</b>	<b>16</b>
4.1	Installation der Manager Software .....	16
4.1.1	Systemvoraussetzungen .....	16
4.1.2	Installation der Manager Software .....	16
4.2	Erstinbetriebnahme.....	18
4.2.1	Akku laden .....	18
4.2.2	SIM-Karte einlegen .....	19
4.2.3	Antennenmontage/-demontage .....	21
4.2.4	Mit X-zone 5x00 verbinden .....	22
4.3	Vom X-zone 5x00 trennen .....	24
<b>5</b>	<b>Konfigurieren des X-zone com .....</b>	<b>25</b>
5.1	Herstellen einer Verbindung zum PC .....	25
5.1.1	Bluetooth-Verbindung .....	25
5.1.2	Leitungsgebundene Verbindung.....	26
5.2	Überblick/Startansicht.....	27
5.3	Verbindungsinformationen.....	28
5.3.1	Erstellen einer Verbindung zum X-zone Com .....	28
5.3.2	Gerätebezeichnung / Messortname ändern .....	29
5.3.3	X-zone Com Einstellungen speichern und laden.....	30
5.3.4	Datenhistorie anzeigen .....	30

5.4	X-zone Com Konfiguration.....	32
5.4.1	Formular "Gerät" .....	33
5.4.2	Formular "Datenlogger" .....	34
5.4.3	Formular "GSM/GPRS" .....	35
5.4.4	Formular "E-Mail" .....	36
5.4.5	Formular "SMS" .....	38
5.4.6	Formular "Status".....	39
5.5	Messwertebereich.....	40
<b>6</b>	<b>Bedienung am X-zone Com .....</b>	<b>41</b>
6.1	Bedienfeld.....	41
6.2	Gerät einschalten.....	41
6.3	Gerät ausschalten.....	42
6.4	Displayanzeigen .....	42
6.4.1	Übersicht Symbole.....	42
6.4.2	Fehleranzeigen .....	43
6.5	Funktionsprüfung durchführen.....	44
<b>7</b>	<b>SMS an das X-zone Com.....</b>	<b>45</b>
7.1	Lesende SMS-Befehle.....	46
7.1.1	Statusabfrage.....	46
7.1.2	Abfrage von Informationen zum Gruppenstatus.....	47
7.1.3	Messwerte des lokal angeschlossenen X-zone 5x00.....	48
7.1.4	Abfragen der maximalen Messwerte in einer Gruppe .....	49
7.1.5	GPS-Koordinaten anzeigen .....	50
7.1.6	Abfrage von aktuellen Alarmen.....	51
7.2	Ausführende SMS-Befehle .....	53
7.2.1	Alarmquittierung.....	53
7.2.2	Evakuierungsalarm aktivieren.....	53
7.2.3	Evakuierungsalarm beenden .....	54
<b>8</b>	<b>Kurzübersicht Mcloud.....</b>	<b>55</b>
8.1	Mcloud Geräteliste .....	55
8.2	Mcloud Gerätestatus.....	57
8.3	Mcloud Messwerte.....	58
8.4	Mcloud Kartendarstellung .....	59
<b>9</b>	<b>Wartung und Instandhaltung .....</b>	<b>61</b>
9.1	Intervalle .....	61
9.2	Reinigen.....	61
9.3	Wechseln des Akkus im Reparaturfall.....	61
<b>10</b>	<b>Anhang.....</b>	<b>62</b>
10.1	Fehlercodes .....	62
10.2	Bestellliste.....	63
10.3	Firmware Update .....	64
10.4	Zertifikate .....	66

# 1 ALLGEMEINES

## 1.1 FUNKTIONSBESCHREIBUNG

Die Lokalisierungs- und Kommunikationseinheit X-zone Com ist für den Einsatz in industriellen Umgebungen vorgesehen. Es erweitert das Gaswarnsystem Dräger X-zone 5x00 mit Dräger X-am 5x00 (im Folgenden X-zone 5x00 genannt).

Angeschlossen an eine X-zone 5x00, liest das X-zone Com regelmäßig Gaskonzentrationen und Alarmwerte vom X-zone 5x00 aus und speichert diese solange zwischen, bis es sie an den ORI Mcloud-Server oder einen vom Benutzer definierten E-Mail-Empfänger versenden kann. Ist das X-zone 5x00 (drahtlos oder per Kabel) mit weiteren X-zone 5x00 verbunden, werden zusätzlich die Alarmwerte des Netzwerks übermittelt. Im Falle eines geschlossenen X-zone Netzwerks (Gruppe) werden statt der Gasmesswerte des angeschlossenen X-zone 5x00 die maximalen Gaskonzentrationen der Gruppe ausgelesen, gespeichert und versendet.

Das X-zone Com fügt allen Messwerten des X-zone 5x00 Positionsdaten hinzu, sofern es eine GPS-Position ermitteln konnte.

Weiterhin ist es in der Lage, Statusanfragen per SMS zu empfangen und per SMS zu beantworten und versendet sowohl E-Mails als auch SMS im Alarmfall.

Über Bluetooth oder eine serielle Verbindung kann der Benutzer das X-zone Com mit Hilfe einer PC-Software (im Folgenden Manager Software genannt) konfigurieren.

## 1.2 BESTIMMUNGSGEMÄßE VERWENDUNG

Das X-zone Com kann in explosionsgefährdeten Umgebungen der Zone 1 und 2 (gemäß  II **2G Ex ib [Ia IIC Ga] [Ib IIC] IIB T3/T4 Gb**) zusammen mit dem Alarmverstärker Dräger X-zone 5x00 betrieben werden. Eine andere, darüber hinausgehende Verwendung oder ein Umbau des Gerätes ohne schriftliche Absprache mit dem Hersteller gilt als nicht bestimmungsgemäß und führt zum Verlust der ATEX-Zulassung und der Garantie!

Für Schäden aus unsachgemäßem oder nicht bestimmungsgemäßem Gebrauch haftet der Hersteller nicht, das Risiko trägt allein der Betreiber. Wenn das Gerät unsachgemäß oder nicht bestimmungsgemäß eingesetzt wird, können Gefahren von ihm ausgehen. Wenn wahrzunehmen ist, dass ein gefahrloser Betrieb nicht mehr möglich ist, setzen Sie bitte das Gerät sofort außer Betrieb.

Zur bestimmungsgemäßen Verwendung gehört auch die genaue Kenntnis und Beachtung dieser Gebrauchsanleitung.



### HINWEIS

Lesen Sie sorgfältig die separaten Gebrauchsanweisungen des Dräger X-zone 5x00 und der angeschlossenen Gasmessgeräte Dräger X-am 5x00 durch. Beachten Sie besonders die jeweiligen Sicherheitshinweise.

## 1.3 LAGERUNG UND RÜCKSENDUNG

**Lagerung:** Trennen Sie evtl. bestehende Verbindungen mit dem X-zone 5x00. Beachten Sie bitte die Herstellervorschriften für das X-zone 5x00. Lagern Sie das ausgeschaltete X-zone Com mit angeschlossenem Ladegerät außerhalb der Ex-Zone und nicht im Freien. Bei einer Lagerung ohne Ladegerät muss spätestens nach 6 Monaten eine komplette Aufladung des internen Akkus über 48 Stunden erfolgen.

**Rücksendung:** Folgende Maßnahmen müssen ergriffen werden, bevor das Gerät an ORI Abwassertechnik GmbH & Co. KG, z. B. für Reparaturzwecke, zurückgesendet wird:

- Entfernen Sie alle Verunreinigungen. Dies ist besonders wichtig, wenn die Verunreinigungen gesundheitsgefährdend sind, z. B. brennbar, giftig, ätzend, krebserregend usw.

Kosten, die aufgrund mangelhafter Reinigung des Gerätes, für eine eventuelle Entsorgung von Sondermüll oder für Personenschäden (Verätzungen usw.) entstehen, werden dem Betreiber in Rechnung gestellt.

## 1.4 ENTSORGUNG

**Verpackung:** Bewahren Sie die Verpackung des Gerätes für eine spätere Transportverwendung auf. Ansonsten können die verwendeten Verpackungsmaterialien Holz, Pappkarton und PE den üblichen Entsorgungswegen zugeführt werden.

**X-zone Com:** Darf nicht als Siedlungsabfall entsorgt werden (gemäß Richtlinie 2002/96/EG). Achten Sie auf Umweltverträglichkeit, Gesundheitsrisiken und lokale Entsorgungsvorschriften. Reinigen und desinfizieren Sie daher das Gerät und entsorgen Sie dieses an einer der dafür zuständigen Sammelstellen. Nähere Informationen erhalten Sie bei den zuständigen Behörden. Bei Zusendung frei Haus übernehmen wir auf Wunsch die kostenlose Entsorgung Ihres alten X-zone Com. Beachten Sie dazu den Abschnitt Rücksendung im vorherigen Abschnitt.



**Akkublock:** Der im X-zone Com enthaltene Akkublock darf nicht als Siedlungsabfall entsorgt werden (gemäß Richtlinie 2006/66/EG). Er ist gemäß den geltenden Vorschriften bei den lokalen Batteriesammelstellen zu entsorgen.

## 2 SICHERHEITSHINWEISE

### 2.1 SICHERHEITSSZEICHEN UND SYMBOLE

Ein korrekter und zuverlässiger Betrieb des Gerätes ist nur gewährleistet, wenn Sie die Sicherheitshinweise in dieser Gebrauchsanleitung genau beachten. Die in dieser Gebrauchsanleitung enthaltenen Sicherheitshinweise weisen auf den zu erwartenden Gefährdungsgrad hin und sind mit folgenden Symbolen und Farben gekennzeichnet:

**WARNUNG**



Warnungen deuten auf potentielle Gefahrensituationen hin, die zu schweren Verletzungen / Tod von Personen oder zu einem Sicherheitsrisiko führen. Beachten Sie die Arbeitsanweisungen genau und treffen sie entsprechende Vorsichtsmaßnahmen.

**VORSICHT**





„Vorsicht“ weist auf potentielle Gefahrensituationen hin, die – wenn sie nicht ordnungsgemäß behandelt werden – zu Verletzungen, fehlerhaftem Betrieb oder zu Schädigungen am Gerät oder der Umwelt führen können. Beachten Sie die Anleitung genau.

**HINWEIS**



Allgemeine Hinweise, Informationen oder Tipps, jedoch keine Hinweise vor Gefahren.

Sonstige Symbole:

Symbol	Beschreibung
	Schutzkleidung tragen
	Gebrauchsanweisungen lesen

---

## 2.2 SICHERHEITSANWEISUNGEN

---

Die folgenden Sicherheitsanweisungen müssen für das X-zone Com befolgt werden.

### VORSICHT



*Das Gerät muss regelmäßigen Inspektionen und Wartungen durch Fachleute unterzogen werden (siehe IEC 60079-1).*

### WARNUNG



#### **Explosionsgefahr!**

*Bei Beschädigungen des Gehäuses oder Gehäuseteilen muss das Gerät sofort außer Betrieb genommen und gegen unabsichtliche Inbetriebnahme gesichert werden.*

### WARNUNG



#### **Explosionsgefahr!**

*Reparatur-, Service- und Wartungsarbeiten ausschließlich in einer nicht explosionsgefährdeten Umgebung vornehmen.*

### WARNUNG



#### **Lebensgefahr!**

*Unbedingt die Sicherheitsanweisungen der angeschlossenen Dräger X-zone 5x00 und Dräger X-am 5x00 beachten!*

---

## 2.3 BETRIEBSSICHERHEIT

---

**Reparaturen:** Reparaturen und sonstige Eingriffe am Gerät, die nicht in dieser Gebrauchsanleitung beschrieben sind, dürfen ausschließlich direkt beim Hersteller oder durch einen vom Hersteller autorisierten Service ausgeführt werden.

**Technischer Fortschritt:** Der Hersteller behält sich vor, technische Daten ohne spezielle Ankündigung dem entwicklungstechnischen Fortschritt anzupassen. Über Aktivitäten und eventuelle Erweiterungen dieser Anleitung erhalten Sie bei ORI Abwassertechnik GmbH & Co. KG Auskunft.



## 3 AUFBAU UND TECHNISCHE DATEN

Die Angaben in dieser Gebrauchsanleitung gelten ausschließlich für den Gerätetyp, der auf dem Titelblatt angegeben ist.

Das X-zone Com besitzt einen eingebauten Akku, mit dem es innerhalb der ATEX-Zonen (gemäß Richtlinie 94/9/EG) betrieben wird. Die Bedienfelder werden mit Hilfe des mitgelieferten Magnetstiftes bedient. Ein GSM/GPRS-Modem zum Übermitteln von Alarmen, Status und Daten ist eingebaut. Vom X-zone 5x00 übertragene Datenwerte werden in einem internen Datenspeicher abgelegt. Es lassen sich etwa 262.000 Datensätze abspeichern. Der Datenspeicher ist als Ringspeicher ausgeführt, so dass beim Überschreiten der 262.000 Datensätze die jeweils ältesten überschrieben werden.

### 3.1 ABMESSUNGEN

#### 3.1.1 X-zone Com + X-zone 5x00



Abb. 3.1: X-zone Com Abmessungen und X-zone Com mit X-zone 5x00.

### 3.1.2 Ladegerät I.S. Power supply 02617PS



Abb. 3.2: Abmessungen des Ladegerätes.

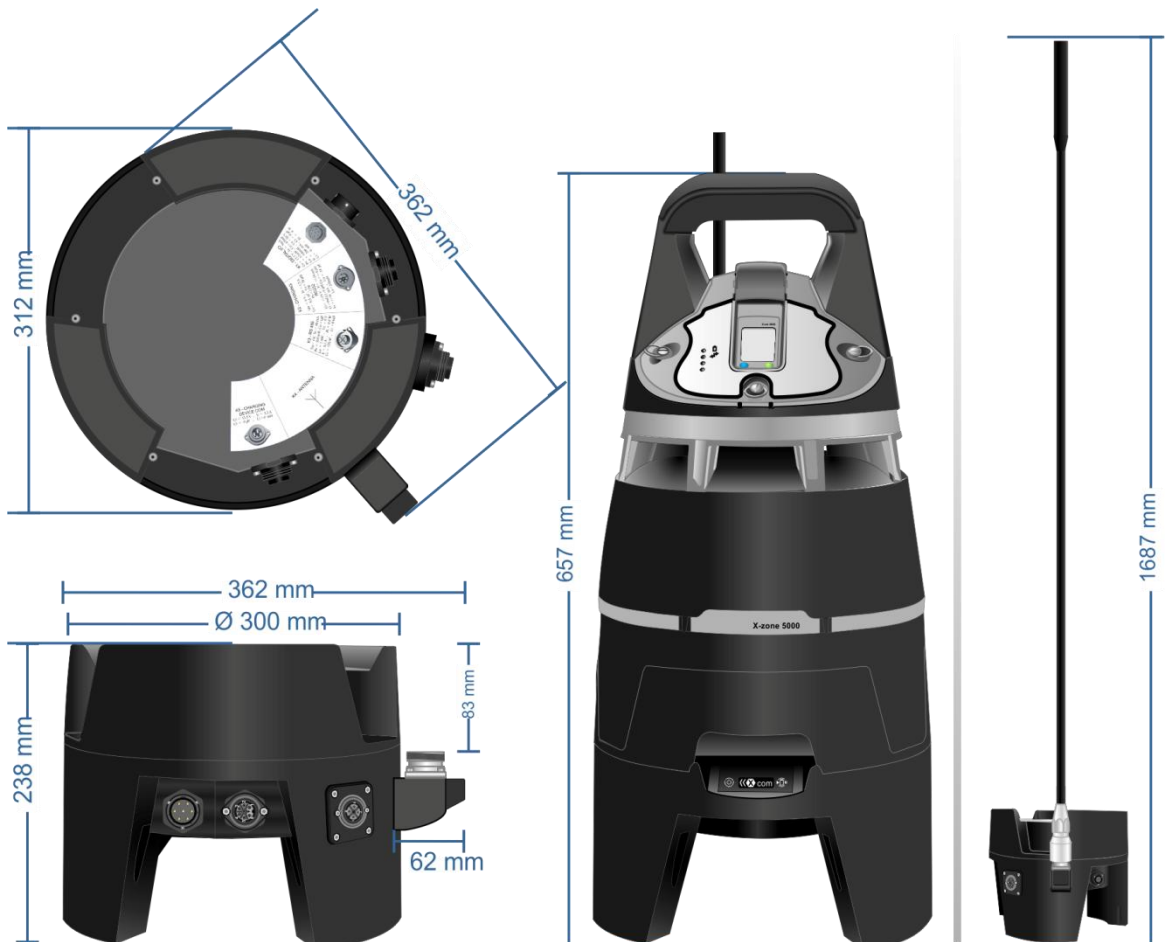

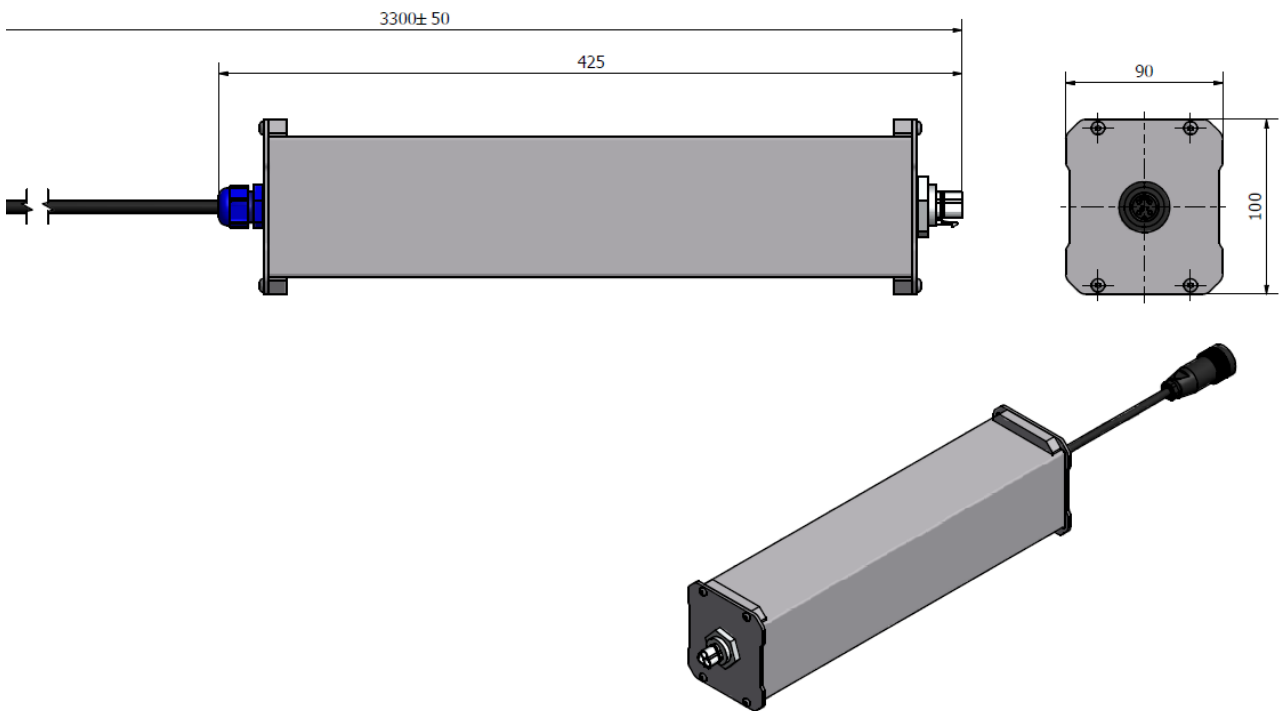

## 3.2 SCHNITTSTELLEN X-ZONE COM UND LADEGERÄT

### 3.2.1 X-zone Com

Das X-zone Com enthält verschiedene Schnittstellen für Datenübertragung (K3=RS485, K2=RS232), einen digitalen Ein-/Ausgang (K1), Anschluss eines Ladegerätes (K5) sowie einen Sockel für die GSM/GPRS Antenne (K4).



Abb. 3.3: Schnittstellenanordnung des X-zone Com.

	Funktion	Ausführung	Ansicht	Belegung
<b>K1</b>	I / O Digital	Stecker 7-polig		3. GND 4. Normally closed (NC) 5. Normally open (NO) 6. Common (COM) 7. Input
<b>K2</b>	RS232 Serielle Schnittstelle (DTE)	Buchse 7-polig		1. TxD 2. CTS 3. RTS 4. Charging + 5. Charging GND 6. GND (RS232) 7. RxD
<b>K3</b>	RS485 X-zone 5x00 Verbindung	Buchse 3-polig+PE		1. PLUS (+) 2. MINUS (-) 3. GND
<b>K4</b>	Antennenbuchse	HF-Buchse 7/16 DIN		
<b>K5</b>	Ladeanschluss X-zone Com	Stecker 3-polig + PE		1. Charging + 2. Charging GND
	Interner Akku	Stecker 7 polig		1. Communication (SCL) 2. Communication (SDA) 3. RESET 4. appliance output (+) 5. appliance GND 6. Input external source (+) 7. Input external source (GND)

### 3.2.2 Ladegerät I.S. Power supply 02617PS

Das Versorgungskabel des Ladegeräts gibt es in drei unterschiedlichen Ausführungen:

Mit Versorgungsstecker	Land / Region	ORI Bestell-Nr.	Dräger Bestell-Nr.
CEE 7/7	Europa	Im Lieferumfang enthalten	8325 391
AS3112	Australien	8094 140	8325 393
BS 1363	Großbritannien	8094 141	8325 392





Abb. 3.4: Versorgungsleitungen des Ladegerätes (für Europa, Australien, Großbritannien).

Funktion	Ausführung	Ansicht	Belegung
<b>Versorgungsstecker</b>	CEE 7/7		
<b>Eingangsverbinder</b>	Wieland RST20i3S 3 polig		1. L1 (schwarz) 2. N (blau) 3. PE (grün/gelb)
<b>Ausgangsbuchse</b>	Binder RD24 Serie 693 - 3-polig+PE		1. PLUS (+) 2. GND 3. Normally closed (NC) 4. Normally closed (NC)

### 3.3 KENNZEICHNUNG

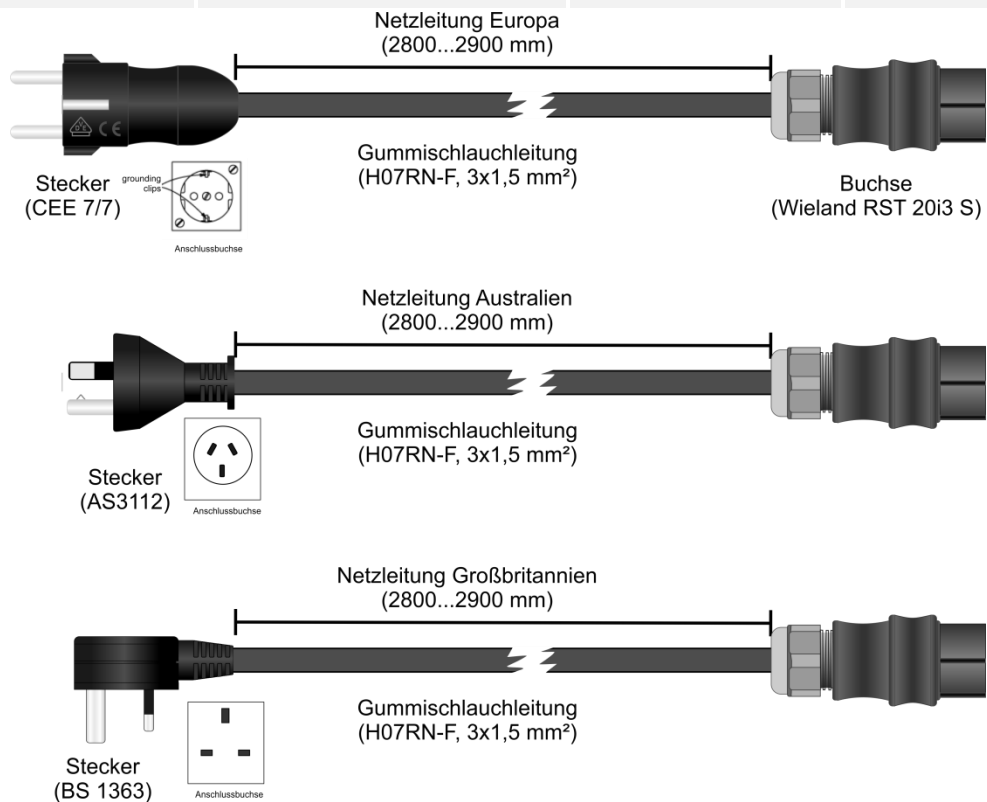
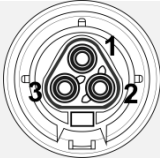
Das Typenschild ist auf der Oberseite des X-zone Com angebracht und enthält folgende Angaben:

- Gerätebezeichnung
- Name und Anschrift des Herstellers
- CE-Kennzeichnung
- Kennzeichnung der Serie und die Typen-Nr.
- Seriennummer, das Baujahr ist in der Seriennummer enthalten
- Zertifizierungsstelle, Jahr der Zulassung, Zulassungsnummer und Gehäuseschutzart
- Ex-Kennzeichnung

Wichtig für alle Rückfragen und Ersatzteilbestellungen ist die Angabe der Gerätebezeichnung sowie der Seriennummer.



Abb. 3.5: **A)** X-zone Com Typenschild auf der Gehäuseoberseite.  
**B)** Anschlussinformationen auf der Gehäuseunterseite.

## 3.4 GERÄTESPEZIFIKATIONEN

### 3.4.1 X-zone Com

Technische Daten:		X-zone Com	
ATEX / IECEX Kennzeichnung	IECEX FTZU 14.0013X FTZU 14 ATEX 0048X	Ex ib [ia IIC Ga] [ib IIC] IIB T3/T4 Gb ⊗ II 2G Ex ib [ia IIC Ga] [ib IIC] IIB T3/T4 Gb	
IP Schutzklasse	<b>IP 67</b>	<i>(bei geschlossenen Steckerverbindungen)</i>	
Maße (ØXH); Gewicht	362 x 238 mm; 9,8 kg	<i>(ohne Dräger X-zone 5x00)</i>	
Temperaturbereiche	<b>Umgebungstemperatur</b>	-10°C .. + 60°C, Temperaturgruppe T3 -10°C .. + 40°C, Temperaturgruppe T4	
	<b>Lagerungstemperatur</b>	-20°C .. + 60 °C <i>(ohne Akku)</i> 0°C .. +50°C <i>(Akku)</i> 0°C .. + 50°C <i>(Ladegerät)</i>	
	<b>Lade, Pufferbetrieb</b>	+5°C .. +30°C <i>(Ladezeit 30 Std.)</i> <i>(mit automatischer Ladeabschaltung bei Akkutemperaturen unter 0°C und höher +45°C)</i>	
Relative Luftfeuchtigkeit	5 - 95%		
Interner Datenspeicher	8 MB – ca. 262000 Datensätze		
Interner Akku (Typ NiMh)	Nennausgangsspannung	12 V	
	Max. Ausgangsspannung	15 V	
	Nennausgangsstrom	0,92 A	
	Kapazität	13,5 Ah	
	Intern wiederaufladbar bei	9...15 VDC / 1,5A	
Drahtlose Kommunikation	<b>Bluetooth</b>	v3.0; class 1 <i>(Antenne intern)</i> , 4dBm ERP	
	<b>GSM/GPRS</b>	Typ MgsM Modem Quadband 850/900/1800/1900 MHz Dualband 900 /1800 MHz	
	<b>Antenne</b> (werkseitig)		
Eigensichere physikalische Schnittstellen	<b>1 x RS485 (K3)</b>	Anschluss Dräger X-zone 5x00	
	<b>1 x RS232 (K2)</b>	RS232 + optional Fremdgeräteaumladung	
	<b>1 x DI/DO (K1)</b>	für optionale Switch ON/OFF Box	
	<b>1 x K5</b>	X-zone Com Netz-/Ladegerät	
	<b>1 x HF 7/16 DIN (K4)</b>	Antenne	
GPS-Modul	Mit interner Antenne		
Display	OLED		
Angewandte harmonisierte Standards.	ETSI EN 300 328 V1.7.1:2006; ETSI EN 301 489-1 V.1.8.1:2008 : ETSI EN 301 489-7/V1.3.1:2005; ETSI EN 301 489-17/ V2.1.1:2009; ETSI EN 301511 V9.02:2003; EN 60079-0: 2012; EN 60079-11:2012; EN 60079-26: 2007 EN 50581:2012; EN 60950-1:2006; EN 61000-6-2:2005; EN 61000-6-3:2007		
Angewandte EU Richtlinie	94/9/EC - ATEX 2004/108/EC - EMC 1999/5/EC - R&TTR		

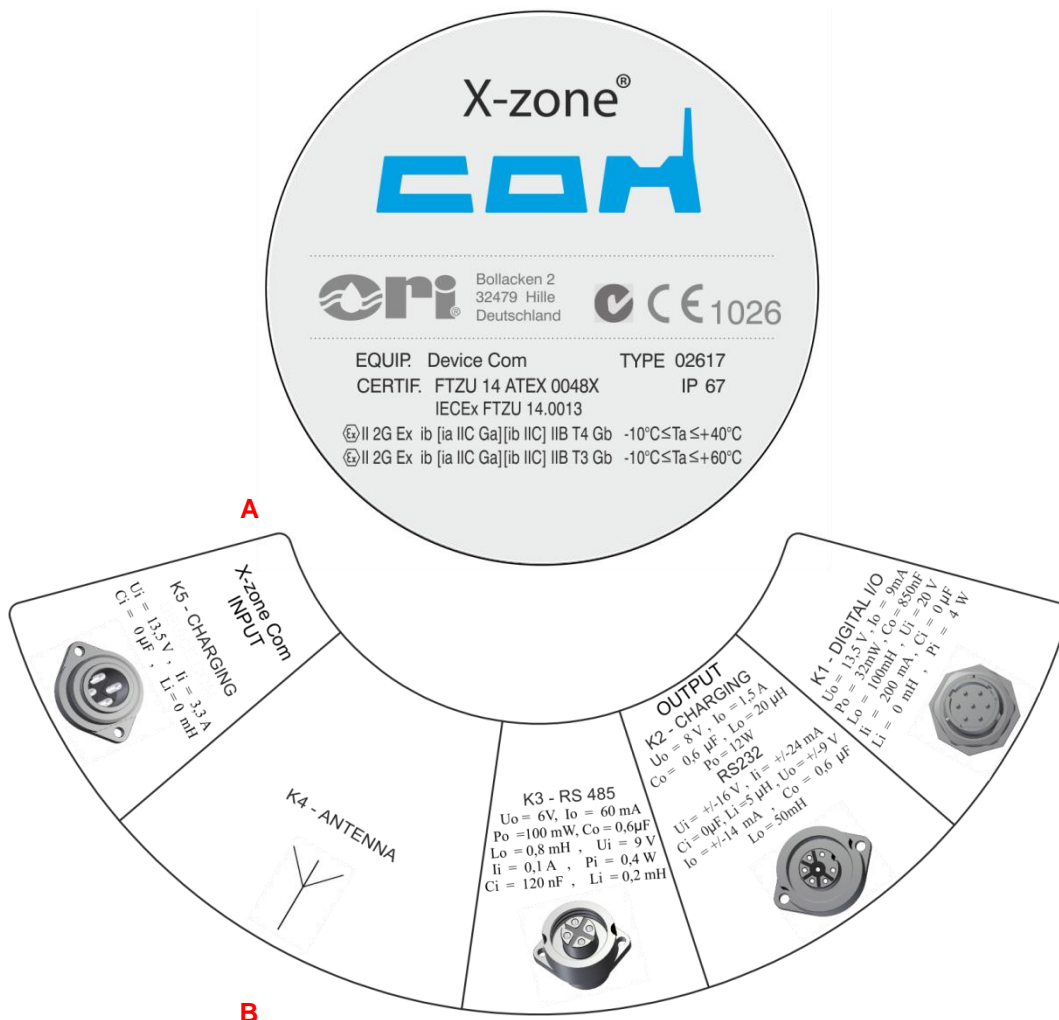
### 3.4.2 Ladegerät

Technische Daten: Ladegerät I.S. Power Supply Unit 02617PS (ORI Art.-No. 8094114)		
IP Schutzklasse	IP 65	⊕ II (2)G [Ex ib Gb] IIB
Elektrische. Schutzklasse	I	
Maße (L x B x H); Gewicht		425 x 90 x 100 mm ohne Kabel 3300 ± 50 x 90 x 100 mit Kabel 1 kg
Umgebungstemperatur während des Ladens		+5°C..+30°C (Ladezeit 30 Std.) (mit automatischer Ladeabschaltung bei Akkutemperaturen unter 0°C und höher +45°C)
Relative Luftfeuchtigkeit	≤ 90%	
Elektrische Daten	<b>Eingangsspannung</b>	90-230 VAC; 47 - 63 Hz 135-370 VDC;
	<b>Eingangsstrom</b>	1 A
	<b>Nennausgangsspannung</b>	12 VDC (nominal)
	<b>Nennausgangsstrom</b>	2 A (nominal)
Eigensichere Spezifikationen	<b>Uo</b>	13,5 V
	<b>Io</b>	2,8 A
	<b>Co</b>	50 nF
	<b>Lo</b>	30 µH

## 4 MONTAGE UND INBETRIEBNAHME

Das X-zone Com muss bei der Erstinbetriebnahme mittels PC-Software (ORI Manager Software) konfiguriert werden. Wie Sie die Manager Software auf Ihrem PC installieren, ist im Folgenden erläutert. Anschließend werden die mechanischen Schritte für die Inbetriebnahme des X-zone Com beschrieben.

### 4.1 INSTALLATION DER MANAGER SOFTWARE

#### 4.1.1 Systemvoraussetzungen

Für die Installation der Manager Software müssen folgende Voraussetzungen erfüllt sein:

- Betriebssystem Microsoft Windows XP / Vista / 7 / 8 - 32bit oder 64bit
- Installiertes Microsoft .NET Framework
- Ca. 10 MB Festplattenspeicher (ohne .NET Framework)

#### HINWEIS



Die Microsoft .NET Framework kann kostenlos von der Microsoft WEB-Seite heruntergeladen werden. Beachten Sie dabei, dass Sie die für ihr Betriebssystem richtige Version herunterladen (32 Bit bzw. 64 Bit). Bei Problemen setzen sie sich mit Ihrem IT-Fachmann in Verbindung.

#### 4.1.2 Installation der Manager Software

Legen Sie die CD ein, der Installationsvorgang startet automatisch. Falls die Installation nicht von alleine startet, führen Sie die Datei "setup.exe" oder "manager\_setup.msi" von Ihrem Installationsmedium aus und folgen den Anweisungen.

#### HINWEIS



Dieses Computerprogramm ist geschützt durch das Urheberrechtsgesetz und internationale Verträge. Unerlaubte Vervielfältigung oder Vertrieb dieses Programms, oder Teile davon, ist nicht erlaubt.

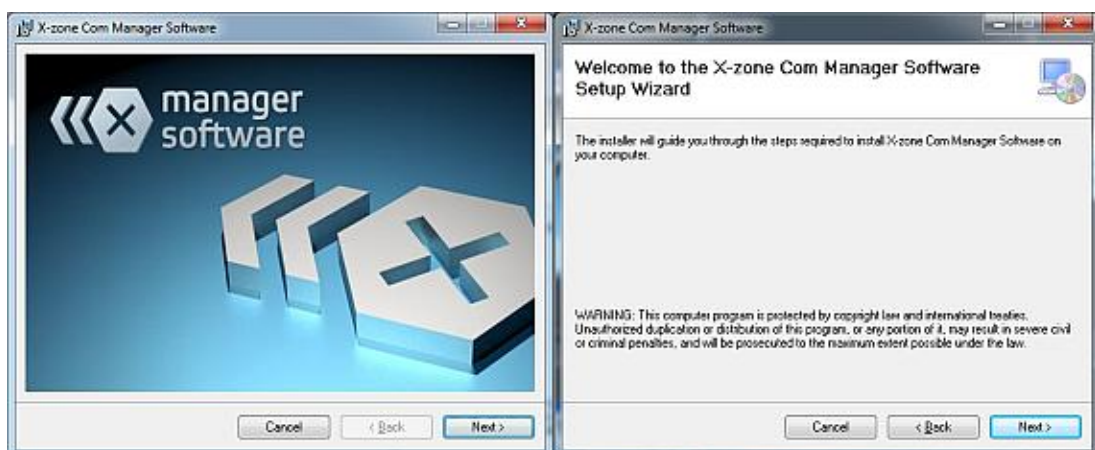





Abb. 4.1: Installationsassistent der Manager Software.

Die Manager Software wird standardmäßig im folgenden Verzeichnis installiert:

`c:\Program Files (x86)\X-zone Com\Manager Software\`

Für die Auswahl eines anderen Verzeichnisses klicken Sie auf [Browse...] oder geben den Speicherpfad in dem Textfeld unterhalb von "Folder:" direkt ein.

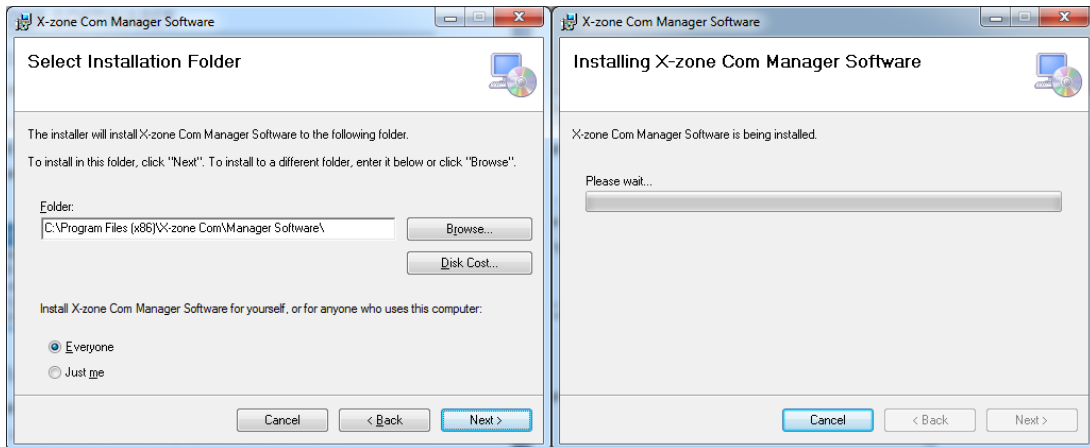
Die Auswahl von [Everyone] bewirkt die Installation der Software für alle Benutzer des PCs.

Die Auswahl von [Just me] bewirkt die Installation der Software nur für den aktuell angemeldeten Benutzer.

Um das Programm in diesem Verzeichnis zu installieren, klicken Sie [Next>] an. Auf dem Desktop wird automatisch eine Programmverknüpfung angelegt.



Abb. 4.2: Erfolgreiche Installation.

Sobald die Installation erfolgreich beendet wurde, schließen Sie den Installationsassistenten mit einem Klick auf [Close].

## 4.2 ERSTINBETRIEBNAHME

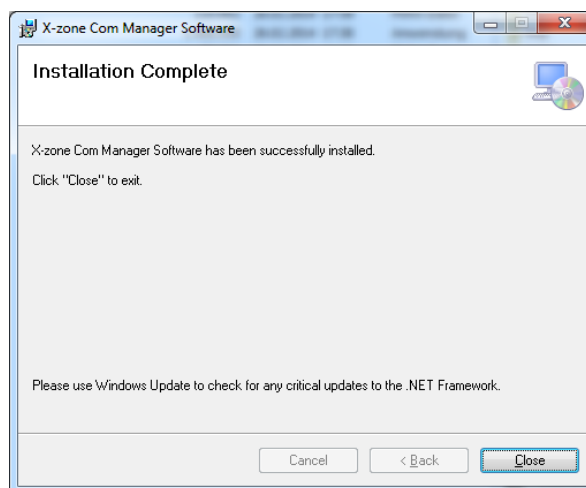

Montage, elektrischer Anschluss, Inbetriebnahme, Bedienung und Wartung des X-zone Com darf ausschließlich durch ausgebildetes Fachpersonal erfolgen. Das Fachpersonal muss die Gebrauchsanleitung gelesen und verstanden haben. Bei Installation, Betrieb, Wartung und Transport tragen Sie die vorgeschriebene Schutzkleidung. Prüfen Sie vor dem Einschalten des Systems noch einmal alle Anschlüsse auf ihre Richtigkeit.

### 4.2.1 Akku laden

Beim Laden des X-zone Com muss sich der Anschluss des Netz-/Ladegerätes (im Folgenden Netzteil genannt) an die Versorgungsspannung außerhalb einer explosionsfähigen Atmosphäre und der ausgewiesenen Ex-Zone befinden. Ferner stellen Sie vor dem Anschließen des Netz-/Ladegerätes an die Versorgungsspannung sicher, dass diese mit dem angegebenen Wert auf dem Typenschild übereinstimmt. Anschließend verbinden Sie das Netzteil mit dem Anschluss K5 des X-zone Com (siehe Kap. 4.2.4).





Abb. 4.3: Das Anschließen des Lade- und Netzgerätes des X-zone Com mit der Versorgungsspannung muss immer außerhalb der ausgewiesenen Ex-Zonen stattfinden.

Während des Ladevorgangs sollte die Umgebungstemperatur zwischen  $+5^{\circ}\text{C}$  und  $+30^{\circ}\text{C}$  liegen, andernfalls kann sich der Ladevorgang verlängern (siehe dazu auch Kap. 6.4).

**WARNUNG**

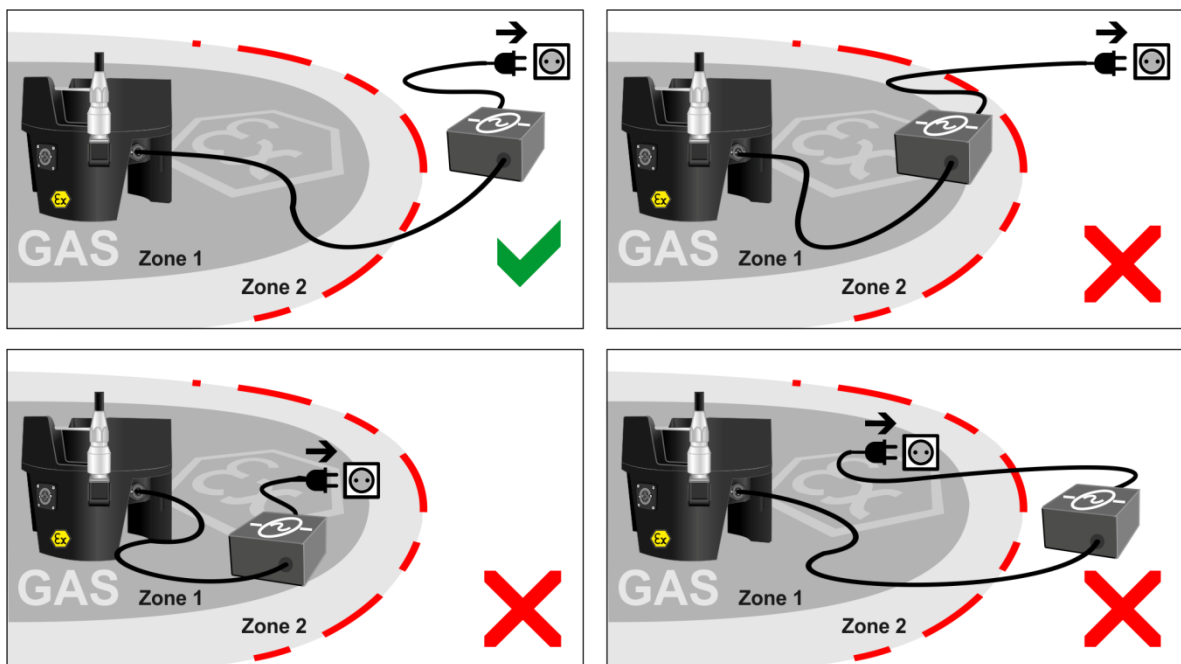



**Explosionsgefahr!**  
Beim Laden des X-zone Com das Netzteil nicht innerhalb der Ex-Zone an die Versorgungsspannung anschließen.

**HINWEIS**



Achten Sie darauf, dass der Akku regelmäßig (spätestens alle 6 Monate) vollständig geladen wird. Andernfalls besteht die Gefahr einer Tiefentladung und Schädigung des Akkus. Lagern Sie das ausgeschaltete X-zone Com mit angeschlossenem Netzteil außerhalb der Ex-Zone.

Im Display des X-zone Com ist die Ladung durch eine zyklisch steigende Akkufüllung ersichtlich (siehe Kap. 6.4)

	<b>Bedeutungen:</b>  1. Akku entladen (X-zone Com schaltet sich aus).  2. Wenn der Akku an das Ladegerät angeschlossen ist, signalisiert das Symbol eine Überhitzung und einen vorübergehende Stopp der Aufladung. Sinkt die Temperatur des Akku wieder wird die Aufladung fortgesetzt.
	Akkuladung 100%

## 4.2.2 SIM-Karte einlegen

Um das X-zone Com für den E-Mail- und SMS-Versand nutzen zu können, muss in das interne Modem eine SIM-Karte eingelegt werden.

Für die Benutzung des GSM Modems müssen kundenseitig M2M SIM Karten eingesetzt werden, welche für die Daten und SMS Kommunikation geeignet sind. Bzgl. des benötigten Datenvolumens und der benötigten SMS Anzahl sollten im Vorfeld mit dem Provider entsprechend passende Verträge kundenseitig ausgewählt werden. SIM Karten, welche auch für eine Sprachkommunikation geeignet sind (gilt auch für Twinkarten) oder welche hauptsächlich für den Einsatz in einem Smartphone, Tablet oder USB/GSM Stick, gedacht sind, sollten im Vorfeld in einem entsprechenden Smartphone/Tablet/USB GSM Stick aktiviert und getestet werden. Dienste wie „Weitervermittlung von Sprachdiensten“ oder ähnliches sollten in diesem Fall deaktiviert werden. Erst nach erfolgreicher Aktivierung/Anpassung, kann die SIM Karte auch im GSM Modem des X-zone Com genutzt werden.

## WARNUNG



### Explosionsgefahr!

Produktgehäuse nicht öffnen innerhalb einer Ex-Atmosphäre!  
Das Einlegen oder Entnehmen einer SIM-Karte darf ausschließlich in einer nicht explosionsgefährdeten Umgebung vorgenommen werden.



Abb. 4.4: X-zone Com Gehäuse öffnen (C=Versorgungsstecker, A = Antennenbuchse).

## HINWEIS

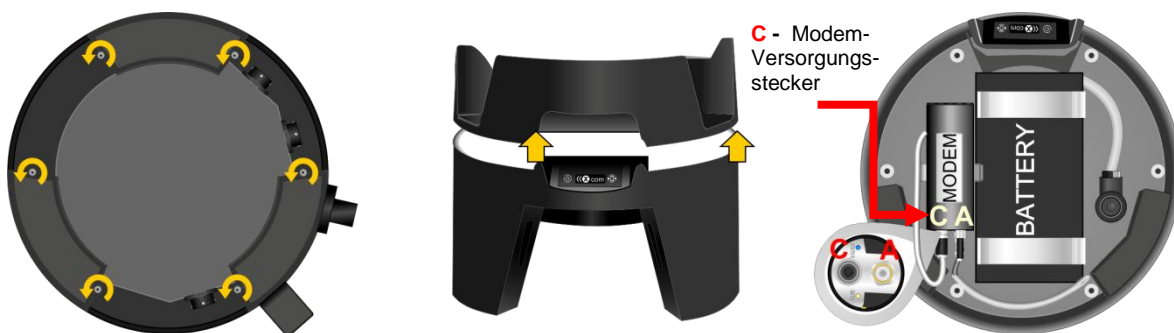

Bevor Sie das Modemgehäuse öffnen, trennen Sie das Modem von seiner Stromversorgung durch das Abziehen des Versorgungssteckers.

Zum Einlegen einer SIM-Karte führen Sie folgende Schritte durch:

1. Lösen Sie die 6 Schrauben auf der Unterseite des X-zone Com.
2. Nehmen Sie das Oberteil des X-zone Com vorsichtig ab.
3. Trennen Sie das Modem von seiner Stromversorgung.
4. Lösen Sie bei Bedarf das Modem aus der Halteklammer.
5. Schrauben Sie den Deckel des Modems ab (siehe Abb. 4.5).
6. Lösen Sie die Verriegelung des Kartenhalters durch Schieben des Kartenhalters in Pfeilrichtung und klappen Sie ihn anschließend auf (siehe Abb. 4.5).
7. Legen Sie die SIM-Karte in die dafür vorgesehene Halterung ein.
8. Klappen Sie den Kartenhalter wieder zu und verriegeln ihn wieder durch Verschieben in die entgegengesetzte Richtung.
9. Schrauben Sie den Deckel des Modems wieder zu.
10. Schließen Sie die Stromversorgung des Modems wieder an.
11. Setzen Sie das Oberteil wieder auf (achten Sie dabei auf den korrekten Sitz der Dichtung).
12. Ziehen Sie die 6 Schrauben wieder handfest an.





Abb. 4.5: SIM-Karte einlegen. Dazu den Deckel vom Modem abschrauben und den Kartenhalter in Pfeilrichtung verschieben und anschließend aufklappen.

### 4.2.3 Antennenmontage/-demontage

<b>WARNUNG</b>	
	<p><b>Explosionsgefahr!</b> An die Antennenbuchse darf nur die originale Antenne (ORI-Bestell-Nr. 8094108, Dräger Bestell-Nr. 8324372) angeschlossen werden.</p>

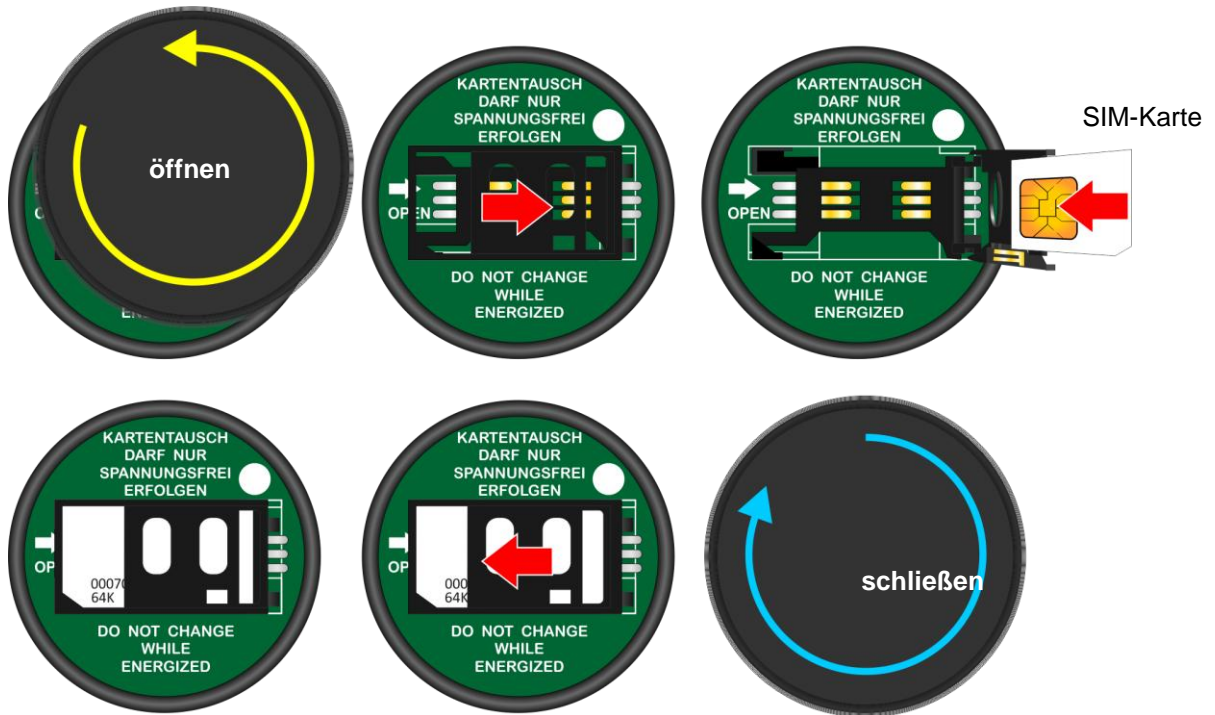
Bei der Antennenmontage oder -demontage nicht am Antennenstab drehen. Zum Fixieren oder Lösen nur an der Überwurfmutter drehen, da ansonsten die Gefahr besteht, dass sich der Mittenkontakt im Antennenfuß löst (Abb. 4.6).



Abb. 4.6: HF-Buchse des X-zone Com

## 4.2.4 Mit X-zone 5x00 verbinden

Verwenden Sie die gelb markierte, beiliegende RS485 Anschlussleitung (Artikel-Nr. 8094118), um den Anschluss K3 des X-zone Com mit dem XEXT2 Anschluss des X-zone 5x00 zu verbinden. Achten Sie dabei darauf, dass der Winkelstecker am X-zone Com nach unten zeigt.



Abb. 4.7: Verbinden des X-zone Com mit dem X-zone 5x00 mit Hilfe der RS485-Anschlussleitung.



Abb. 4.8: Bei der Verbindung mehrerer X-zone 5x00 ausschließlich über Kommunikationskabel wird das X-zone Com an das X-zone 5x00 am Ende der Leitungskette angeschlossen.

**HINWEIS**

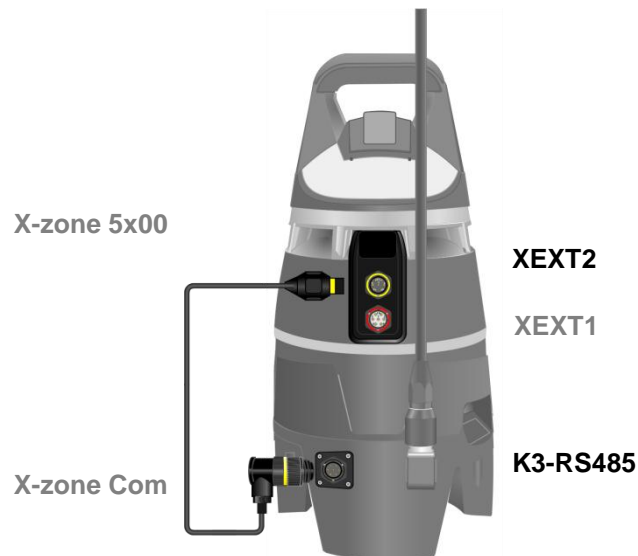
Die Verwendung eines X-zone Com setzt beim angeschlossenen X-zone 5x00 eine Firmware ab Version 2.22 voraus.

Für ein Firmware-Update und die Konfiguration des X-zone 5x00 mittels der PC-Software Dräger CC-Vision setzen Sie sich mit Ihrem Dräger-Kundenberater in Verbindung.

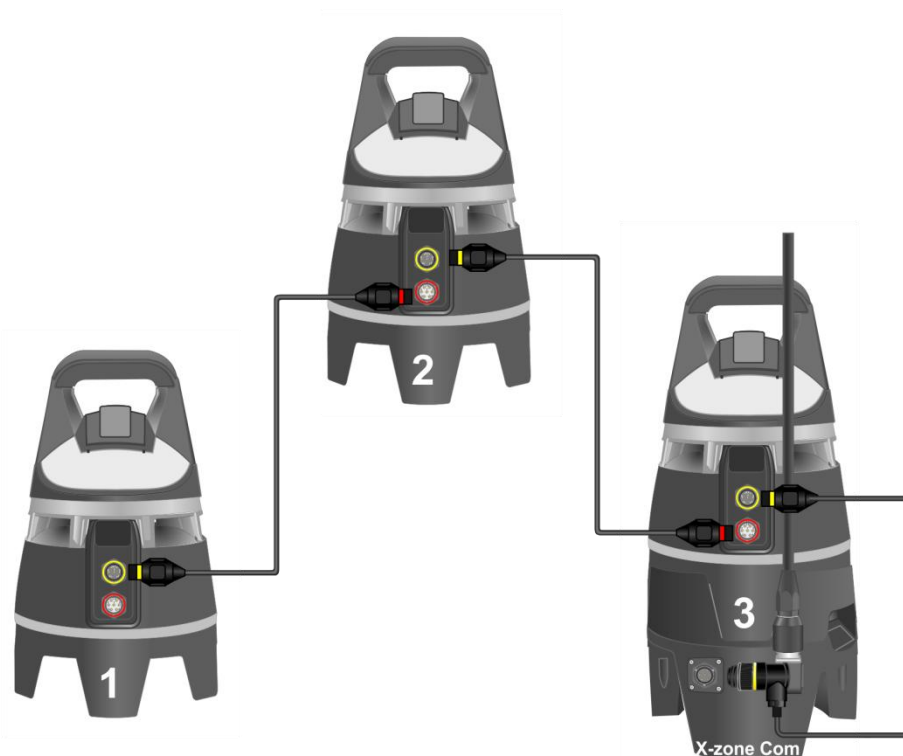
Achten Sie darauf, dass im X-zone 5x00 das Modbus-Protokoll mit Hilfe der PC-Software Dräger CC-Vision eingeschaltet und wie folgt konfiguriert wurde:

X-zone 5x00 Modbus-Einstellungen	
Modbus-Verbinder	XEXT2
Modbus-Adresse	2
Baudrate	115200
Parität	Even



Abb. 4.9: Modbus-Einstellungen innerhalb der PC-Software Dräger CC-Vision.

**Unterschied zwischen geschlossenem und offenem Netzwerk:**

Eine detaillierte Beschreibung der Netzwerkfunktionalitäten finden Sie in der Gebrauchsanweisung des X-zone 5x00 von Dräger.

*„Bei einem geschlossenen Funknetz überwacht ein Hauptgerät die Funkverbindung zu allen Gruppengeräten und alle Gruppengeräte überwachen die Funkverbindung zum Hauptgerät. Wenn ein Gerät ausfällt, z. B. durch einen leeren Akku oder Wegnahme eines Geräts, wird am Hauptgerät ein Gerätealarm ausgelöst. Bei Ausfall des Hauptgeräts wird bei allen Gruppengeräten ein Gerätealarm ausgelöst.“*

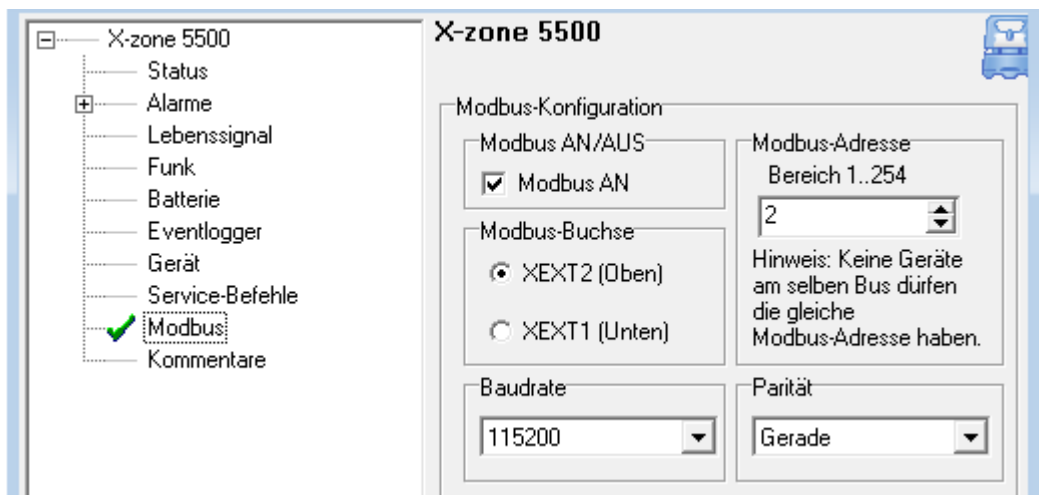
Die folgende Tabelle zeigt die unterschiedliche Behandlung durch das X-zone Com. Die Verwendung der Serien- oder Stationsnummer sowie lokalen Messwerten oder Maximalwerten gilt sowohl für vom X-zone Com versendete E-Mails und SMS als auch für das Internetdatenportal Mcloud und die Manager Software.

	Offenes Netzwerk	Geschlossenes Netzwerk (Gruppe)
<b>Identifikationsnummer des X-zone 5x00</b>	Seriennummer	ID innerhalb der Gruppe (Stationsnummer)
<b>Verwendeter Messwert für ein Gas</b>	Aktueller Messwert des angeschlossenen X-zone 5x00	Aktueller Maximalwert aus der Gruppe
<b>Alarminformationen</b>	✓	✓
<b>Maximale Anzahl an X-zone 5x00 im Netzwerk</b>	25	15

#### HINWEIS



Das X-zone Com kann an jedes beliebige X-zone 5x00 im Funknetz angeschlossen werden. Es ist nicht notwendig, es z.B. im geschlossenen Netzwerk an das Hauptgerät anzuschließen.

#### HINWEIS



Das X-zone Com sendet regelmäßig ein Signal zum X-zone. Ist die Verbindung länger als eine Minute unterbrochen, signalisiert das X-zone 5x00 einen Gerätefehler.

## 4.3 VOM X-ZONE 5X00 TRENNEN

Ist die Verbindung zwischen X-zone Com und X-zone 5x00 länger als eine Minute unterbrochen, signalisiert das X-zone 5x00 einen Gerätefehler. Um dieses zu vermeiden lassen sie die RS485 Verbindung solange bestehen bis Sie das X-zone Com ausgeschaltet haben (siehe Kap. 6.3). Mit dieser Vorgehensweise wird ein Gerätefehler vermieden.



## 5 KONFIGURIEREN DES X-ZONE COM

Zum Konfigurieren des X-zone Com benötigen Sie die Manager Software, deren Installation in Kap. 4.1 beschrieben wird.

### 5.1 HERSTELLEN EINER VERBINDUNG ZUM PC

Das X-zone Com wird entweder über eine drahtlose Bluetooth- oder eine leitungsgebundene Verbindung mit einem PC verbunden.

#### 5.1.1 Bluetooth-Verbindung

Das Herstellen der Bluetooth-Verbindung ist im Folgenden beispielhaft für Windows 7 beschrieben. Abhängig vom Betriebssystem kann sich der Vorgang geringfügig unterscheiden.

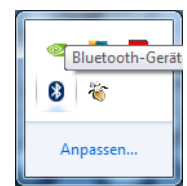

1. Stellen Sie sicher, dass am PC das Bluetooth-Modul aktiviert ist. In den meisten Fällen geschieht dies durch Drücken der blauen, beschrifteten Funktionstasten [FN]+[Bluetooth-Symbol].
2. Vergewissern Sie sich, dass das X-zone Com mit voll aufgeladenem Akku betrieben wird.

Ist das Bluetooth-Modul aktiv, klicken Sie mit der rechten Maustaste das Bluetooth-Symbol  in der Windows-Funktionsleiste an und wählen Sie [Gerät hinzufügen] aus.



Abb. 5.1: Bluetooth-Einbindung des X-zone Com.

Wählen Sie anschließend das Gerät aus und klicken Sie auf [Weiter]. Falls Sie sich erstmalig mit dem X-zone Com verbinden, so bestätigen Sie den angezeigten Kopplungscode (bei MS Windows 7). Durch Klicken auf [Weiter] wird das X-zone Com zu den Bluetooth-Netzwerkgeräten des verwendeten PCs hinzugefügt.

Jede eingerichtete Bluetooth-Verbindung bekommt von MS Windows eine COM-Port-Nummer zugewiesen. Zum Einsehen der Nummer markieren Sie das Gerät und klicken auf [Eigenschaften]. Anschließend wählen Sie das Formular [Dienste] an (siehe Abb. 5.2).

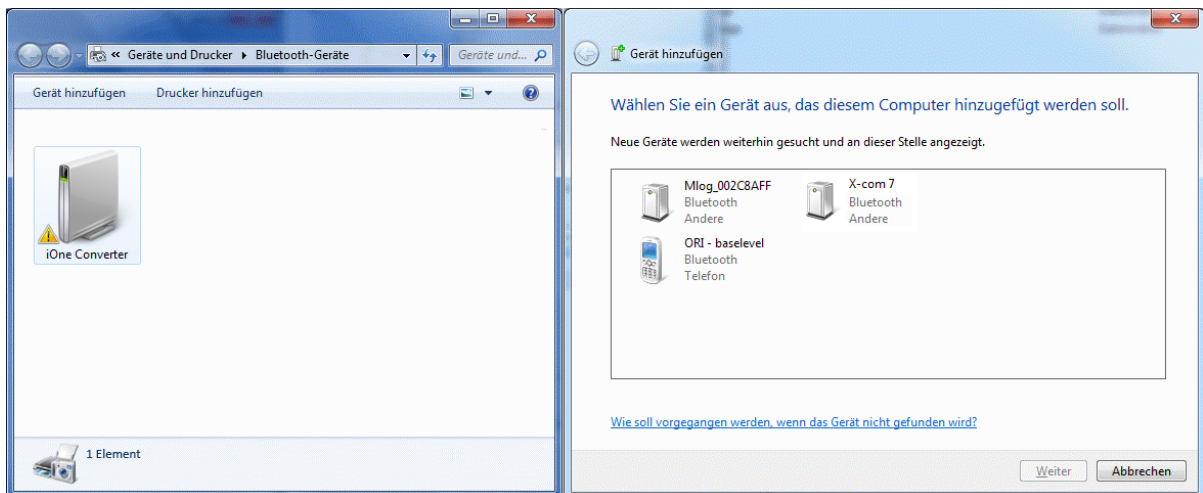

Abb. 5.2: Zugewiesener COM-Port bei MS Windows 7.

Die Manager Software kann den COM-Port automatisch ermitteln; für einen schnelleren Verbindungsaufbau kann der COM-Port in der Manager Software manuell eingestellt werden.

## 5.1.2 Leitungsgebundene Verbindung

Alternativ zur Bluetooth-Verbindung kann das X-zone Com über die K2-Schnittstelle (RS232) via dem beiliegendem Kabel mit einem PC verbunden werden. Üblicherweise wird dafür am PC ein USB-Seriell-Adapter benötigt.

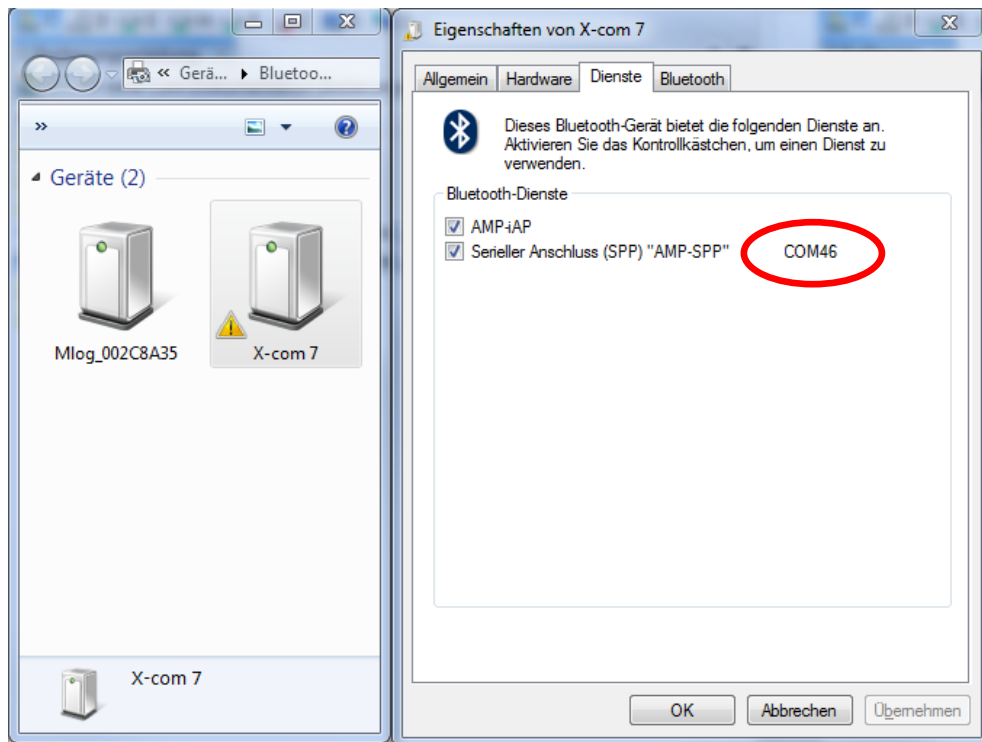
Die von MS Windows zugewiesene COM-Port-Nummer muss auch in diesem Fall von der Manager Software (automatisch oder manuell eingestellt) verwendet werden.

## 5.2 ÜBERBLICK/STARTANSICHT

Das Hauptfenster der Manager Software weist fünf Funktionsbereiche auf, die im Folgenden beschrieben werden.



Abb. 5.3: Startfenster der Manager Software.

<b>1</b>	<b>Logo</b>  Das Logo ist mit der ORI Homepage ( <a href="http://www.origmbh.de/">http://www.origmbh.de/</a> ) verlinkt (Internet-Zugang erforderlich).
<b>2</b>	<b>Verbindungsinformationen</b> <b>Verbindung:</b> [COM-Port]: Auswahl des COM-Ports. [Verbinden]: Stellt eine Verbindung zwischen PC und X-zone Com her. [Trennen]: Beendet die Verbindung. <b>Gerätename:</b> Benutzerdefinierter Geräte name des X-zone Com. <b>Einstellungen:</b> [Speichern]: Einstellungen in das X-zone Com übernehmen. [Laden]: Aktuelle Einstellungen aus dem Gerät auslesen und anzeigen. <b>Datenhistorie:</b>

	[Anzeigen ] Einladen von BSH-Datendateien zur Datenansicht. Exportfunktion.
<b>3</b>	<b>Konfigurationsbereich</b> Geräte-, Logger-, und Kommunikationseinstellungen setzen. Zusätzlich sind verschiedene Informationen wie Geräte-ID, Gerätezustand und Batteriestatus ersichtlich.
<b>4</b>	<b>Messwertebereich:</b> Bei einem offenen Netzwerk werden die aktuellen Messwerte des lokal angeschlossenen X-zone 5x00 angezeigt. Im Alarmfall werden zusätzlich die Alarmwerte des alarmgebenden Gerätes angezeigt. Bei einem geschlossenen Netzwerk werden die aktuellen Maximal- und Alarmwerte aus der Gruppe angezeigt.
<b>5</b>	<b>Statusleiste</b> Zeigt den Verbindungsstatus zum X-zone Com an. Außerdem kann die Sprache der Manager Software gewählt und die Version der Manager Software eingesehen werden.

## 5.3 VERBINDUNGSINFORMATIONEN

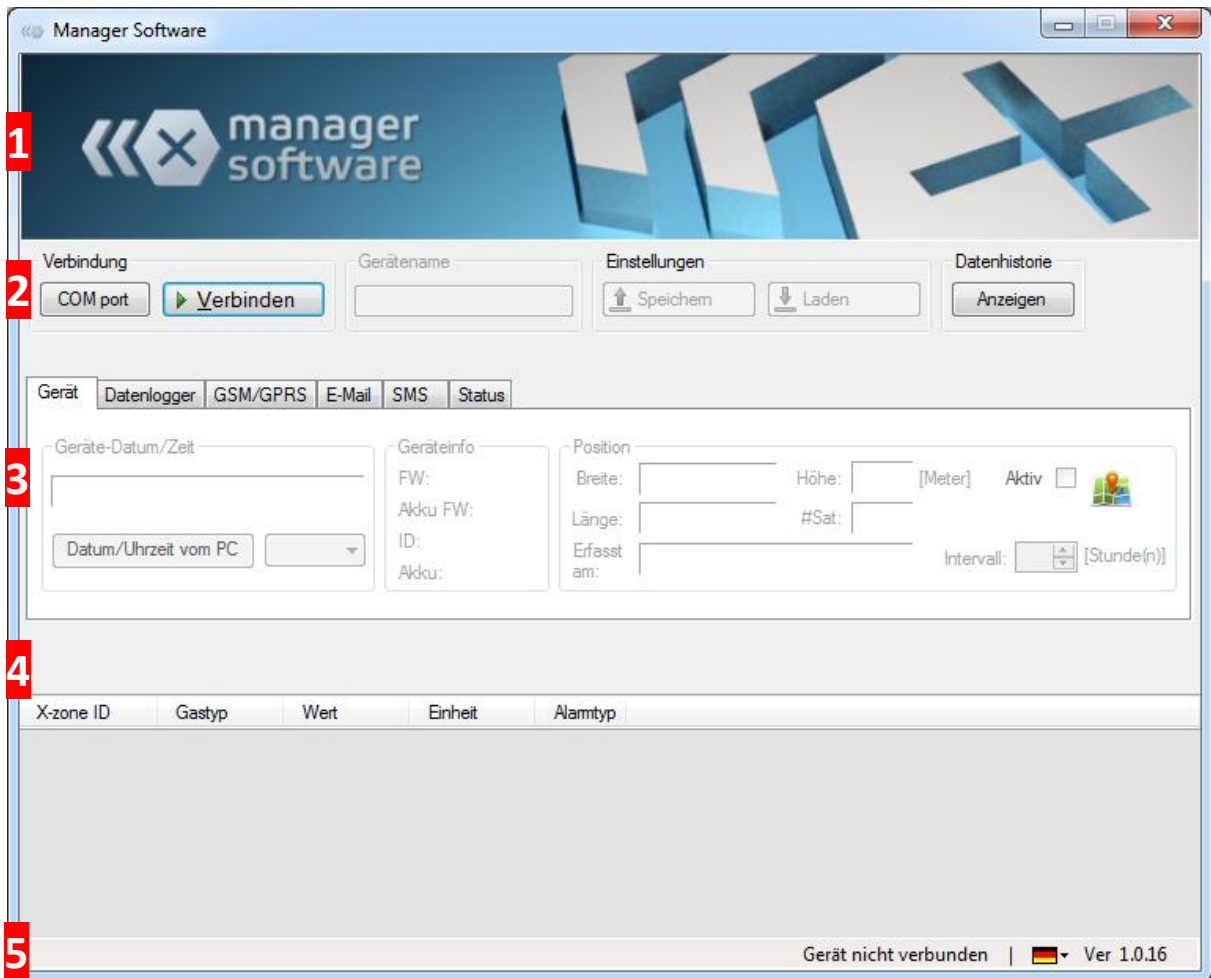
### 5.3.1 Erstellen einer Verbindung zum X-zone Com

Eine Verbindung zwischen PC und X-zone Com kann entweder über das RS232-Verbindungskabel oder via Bluetooth erfolgen. Falls die Verbindung über das RS232-Verbindungskabel erfolgt, wird i.d.R. der COM-Port 1 zugewiesen.

**HINWEIS**



Für eine erfolgreiche Bluetooth-Verbindung muss das Bluetooth-Modul des PCs aktiv und dem Gerät vom Betriebssystem ein virtueller ComPort zugewiesen worden sein. Näheres finden Sie in Kap. 5.1

Die Manager Software kann den COM-Port für die serielle Bluetooth-Verbindung automatisch suchen oder Sie weisen den COM-Port manuell zu.

#### 5.3.1.1 Automatische Suche

Die automatische Suche des COM-Ports ist nach der Installation der Software die Standard-Einstellung. Der Haken bei [automatische Suche] muss - wie in Abb. 5.5 gezeigt - gesetzt sein.

Klicken Sie auf [Verbinden], um den Verbindungsaufbau zu starten. In der Statusleiste erscheint „Suche nach Gerät an:“ sowie die Angabe, an welchem COM-Port aktuell nach dem Gerät gesucht wird.





Abb. 5.4: Statusleiste der Manager Software beim erfolgreichen Verbindungsaufbau.

### 5.3.1.2 Manuelle COM-Port-Auswahl

**HINWEIS**

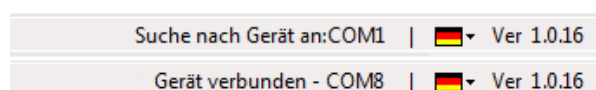
 Eine manuelle Auswahl des ComPorts ist immer sinnvoll, wenn Sie mehrere X-zone Com besitzen, da ansonsten immer mit dem ersten gefundenen X-zone Com eine Verbindung hergestellt wird.

Zur manuellen Auswahl der vom Betriebssystem vergebenen COM-Port-Nummer klicken Sie die Schaltfläche [COM port] an). Es öffnet sich das unten abgebildete Fenster "COM Port". Entfernen Sie den Haken bei [automatische Suche] und wählen anschließend die vom Betriebssystem für das X-zone Com vergebene COM-Port-Nummer aus der Liste aus.



Abb. 5.5: Manuelle Auswahl des virtuellen COM-Ports der Bluetooth- oder seriellen Schnittstelle.

### 5.3.2 Gerätebezeichnung / Messortname ändern

Dem X-zone Com kann unter "Gerätename" ein benutzerdefinierter Name (z.B. ein Messort) zugewiesen werden (nicht zulässig Zeichen: „\$“, „°“, deutsche Umlaute und „ß“). Unter diesem Namen werden in der ORI Mcloud alle übertragenen Messwerte angezeigt. Bei Werksauslieferung entspricht der Gerätename der Geräte-ID des X-zone.

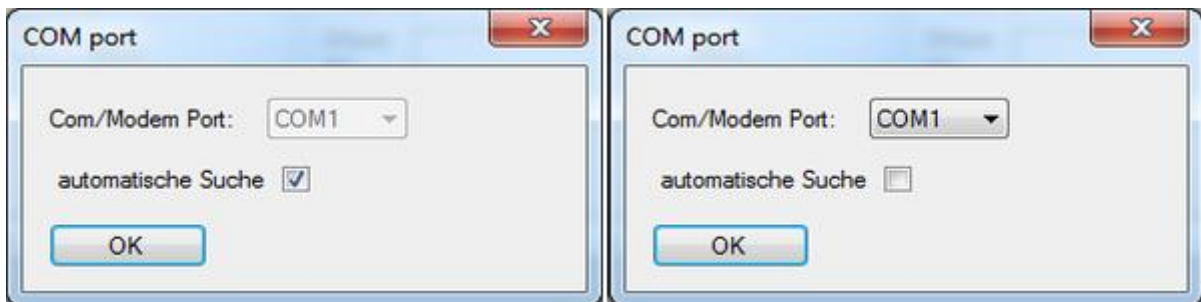

Abb. 5.6: Dem X-zone Com einen Namen zuweisen.

Durch Anklicken von [Speichern] wird der Name in das X-zone Com geschrieben. Es können max. 10 Zeichen für den Namen eingegeben werden. Umlaute und Sonderzeichen sind dabei nicht zulässig. Wurde kein oder ein ungültiger Name vergeben, können die Einstellungen nicht in das X-zone Com übertragen werden und es erscheint eine Fehlermeldung.

**HINWEIS**

 Der vergebene Gerätename wird zur Registrierung des X-zone Com in der Mcloud benötigt.

### 5.3.3 X-zone Com Einstellungen speichern und laden

Die vorgenommenen Einstellungen werden über [Speichern] in das X-zone Com geschrieben, sofern alle Einträge gültig sind. Ungültige Einträge werden rot markiert, das Speichern ist dann nicht möglich.

Mit Anklicken von [Laden] werden die gegenwärtigen Einstellungen aus dem X-zone Com ausgelesen und von der Manager Software angezeigt.



Abb. 5.7: Einstellungen in das X-zone Com übertragen oder auslesen.

### 5.3.4 Datenhistorie anzeigen

**HINWEIS**

Um die Datenhistorie in der Manager Software nutzen zu können, müssen Sie nicht mit dem X-zone Com verbunden sein.

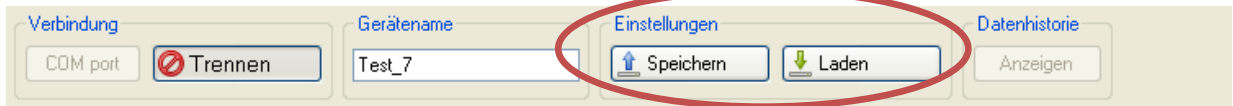
Nach drücken von [Anzeigen] unter "Datenhistorie" erscheint ein Fenster zum öffnen von via E-Mail versendeter BSH-Datendateien. Zum Auswählen eines Messdatensatzes die Schaltfläche [...] drücken und die entsprechende Datendatei auswählen. Mit Klick auf [Laden] werden die Messdaten der ausgewählten Datei in einer Tabelle im Formular [Daten] angezeigt.

Typ	Date Zeit	Gastyp	Wert	Einheit	Alarmtyp	X-zone ID
L	25.04.2014 07:43	O2	20,9	Vol%	OK	AREH-0008
L	25.04.2014 07:43	ch4	0	%UEG	OK	AREH-0008
L	25.04.2014 07:43	O2	20,9	Vol%	OK	AREH-0008
L	25.04.2014 07:43	ch4	0	%UEG	OK	AREH-0008
L	25.04.2014 07:43	O2	20,9	Vol%	OK	AREH-0008
L	25.04.2014 07:43	ch4	0	%UEG	OK	AREH-0008
L	25.04.2014 07:43	O2	20,9	Vol%	OK	AREH-0008
L	25.04.2014 07:43	ch4	0	%UEG	OK	AREH-0008
L	25.04.2014 07:44	O2	20,9	Vol%	OK	AREH-0008
L	25.04.2014 07:44	ch4	0	%UEG	OK	AREH-0008
L	25.04.2014 07:44	O2	20,9	Vol%	OK	AREH-0008

Abb. 5.8: Tabellenansicht der Messdatensätze einer eingeladenen BSH-Datendatei im Daten-Viewer.

Bedeutung einiger Spalten innerhalb der Tabellenansicht:

Tabellenspalte	Wert	Bedeutung
Typ	L	Lokaler Messwert
	M	Maximalwert des Gases in der Gruppe
	E	Fehler
Wert		Geloggter Gasmesswert
Einheit	Vol%, %UEG, %LEL, %LIE, ppm, mg/m3, ppb, mbar,	Messwerteinheiten

	hPa, kPa, mg/L	
Alarmtype	OK	Messwert im normalen Bereich
	A1	A1 Alarm
	A1_Q	A1 Alarm quittiert
	A2	A2 Alarm
	A2_Q	A2 Alarm quittiert
	Err	Gerätefehler
	Err_Q	Gerätefehler quittiert

Für den Export der Datensätze in eine CSV-Datei, betätigen Sie die Schaltfläche [Speichern als]. Anschließend wählen Sie den Ordner aus wo die Datei gespeichert werden soll und entscheiden ob die Datensätze in Ihrer auf dem PC installierten Tabellenkalkulation geöffnet werden sollen.

Wählen Sie das Formular [Gerät] um die in der Datendatei enthaltenen Informationen über das Gerät, GPS, Alarmer und Akkukapazitäten zu sehen.



Abb. 5.9: Informationen zum X-zone Com zum Zeitpunkt der Übertragung der BSH-Datei im Übersichtsformular [Gerät] des Daten-Viewer.



## 5.4 X-ZONE COM KONFIGURATION

Im Konfigurationsbereich des Fensters werden aktuelle Einstellungen des X-zone Com angezeigt. Die einzelnen Formulare werden im Folgenden erläutert.

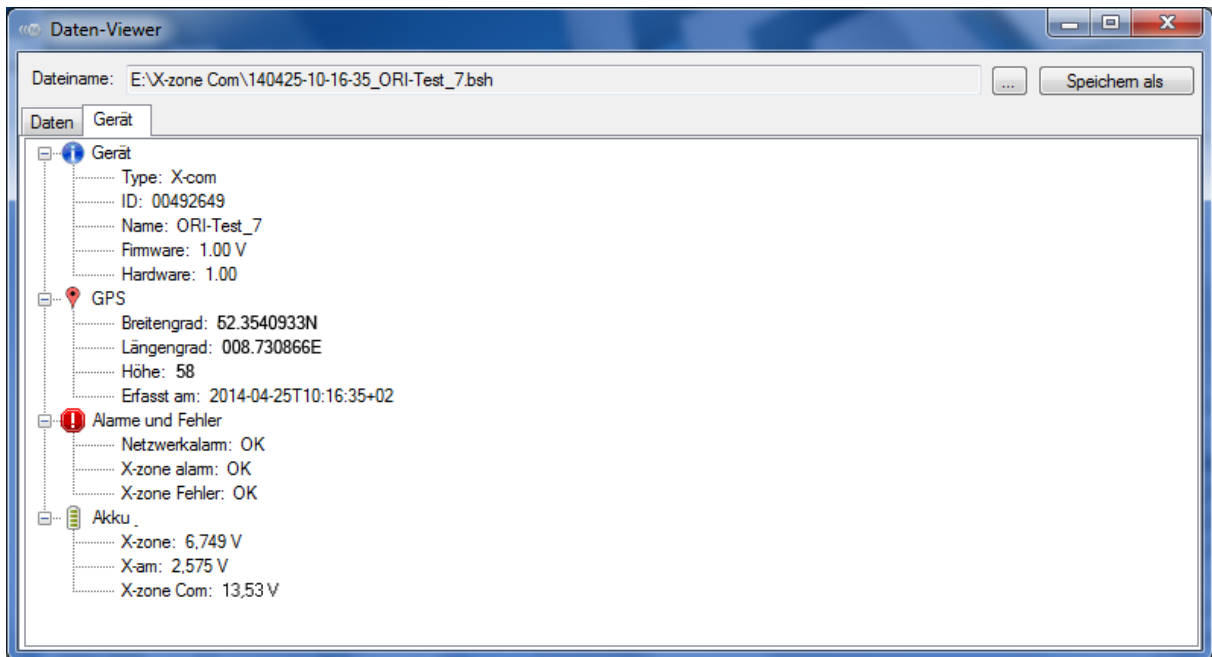
The screenshot shows the 'Manager Software' window. At the top, there's a header with the 'manager software' logo. Below it, there are four main sections: 'Verbindung' (Connection), 'Gerätename' (Device Name), 'Einstellungen' (Settings), and 'Datenhistorie' (Data History). The 'Verbindung' section has a 'COM port' dropdown and a 'Trennen' (Disconnect) button. 'Gerätename' has a text input field with 'ORI-Test\_7'. 'Einstellungen' has 'Speichern' (Save) and 'Laden' (Load) buttons. 'Datenhistorie' has an 'Anzeigen' (Show) button. Below these is a row of tabs: 'Gerät', 'Datenlogger', 'GSM/GPRS', 'E-Mail', 'SMS', and 'Status'. The 'Gerät' tab is highlighted with a red circle. The main content area is divided into three columns: 'Geräte-Datum/Zeit' (Device Date/Time) with a date/time input and a 'UTC+02' dropdown; 'Geräteinfo' (Device Info) with fields for FW, Akku FW, ID, and Akku; and 'Position' (Position) with fields for Breite, Höhe, Länge, #Sat, and Erfasst am, plus an 'Aktiv' checkbox and a location icon. At the bottom, there's a table titled 'Aktuelle MAXIMALE Sensorwerte' (Current MAXIMAL Sensor Values) with columns for X-zone ID, Gastyp, Wert, Einheit, and Alarmtyp. The status bar at the bottom right shows 'Gerät verbunden -COM15' and 'Ver 1.0.16'.

X-zone ID	Gastyp	Wert	Einheit	Alarmtyp
0	O2	20,9	Vol%	
0	H2S	0	ppm	
0	CO	0	ppm	
1	CO2	0,19	Vol%	
1	ch4	0	%LEL	

Abb. 5.10: Verschiedene Formulare für allgemeine Einstellungen, Datenlogger-, GSM-, E-Mail- und SMS-Einstellungen.

Mit Ausnahme des Geräte-Datums und der Geräte-Zeit müssen alle vorgenommenen Einstellungen mit der Schaltfläche [Speichern] (bei Einstellungen) zum X-zone Com übertragen werden.



## 5.4.1 Formular "Gerät"

Im Formular "Gerät" lassen sich allgemeine Gerätewerte und Informationen einsehen und setzen.

The screenshot shows the 'Gerät' configuration interface with the following fields and values:

Geräte-Datum/Zeit	Geräteinfo	Position
30 Mai 2014 16:00:23	FW: 1.00 Z Akku FW: 1.04 ID: 00492649 Akku: 13,53 V	Breite: 52.3542150N Höhe: 67 [Meter] Aktiv <input type="checkbox"/> Länge: 008.7308350E #Sat: 5 Erfasst am: 30.05.2014 15:42:26
Datum/Uhrzeit vom PC UTC+02		Intervall: 1 [Stunde(n)]

Abb. 5.11: Allgemeine Geräteinformationen wie z.B. die aktuelle Gerätezeit und GPS-Koordinaten.

**Geräte-Datum/Zeit:** Die angezeigte Zeit setzt sich aus der "Universal Time Coordinated [UTC]" und der Zeitzone zusammen, z.B. in Mitteleuropa:

1. Normal: UTC+1
2. Sommerzeit: UTC+2

Durch Anklicken der Schaltfläche [Datum/Uhrzeit vom PC] wird das aktuelle Datum und die Uhrzeit des PCs in das Gerät geschrieben. Dies geschieht unter Berücksichtigung der ausgewählten Zeitzone (UTC+1 in Mitteleuropa). Zuvor sollte die Ganggenauigkeit der PC-Uhr geprüft werden.

**HINWEIS**

Sobald ein GPS-Signal empfangen wird, wird die GPS-Zeit verwendet.  
Bei nicht eingestellter Uhr entsprechen die Zeitstempel der Laufzeit seit dem Einschalten des X-zone Com, solange keine GPS-Zeit empfangen wird.

**Info:** Der Info-Bereich zeigt die Versionsnummer der Firmware, die Identifikationsnummer sowie den aktuellen Ladezustand des X-zone Com in Volt.

**Position:** Unter "Position" sehen Sie die ermittelten Positionsdaten, die Anzahl der genutzten GPS-Satelliten sowie wann diese Position ermittelt wurde. Mit "Intervall" legen Sie fest, in welchen Zeitabständen eine erneute GPS-Positionsermittlung durchgeführt werden soll, im Beispiel jede Stunde (Abb. 5.11). Ein kurzes GPS-Intervall verringert die Laufzeit des Akkus.

Durch Klicken auf das Kartensymbol wird bei vorhandenen Koordinaten die Position des Gerätes in Google Maps angezeigt. Voraussetzung dafür ist ein installierter Browser und eine bestehende Verbindung ins Internet.

The close-up shows the 'Position' section with the following fields:

Breite:	52.3542150N	Höhe:	67	[Meter]	Aktiv	<input type="checkbox"/>	
Länge:	008.7308350E	#Sat:	5				
Erfasst am:	30.05.2014 15:42:26		Intervall:	1	[Stunde(n)]		

Abb. 5.12: Intervall, in dem eine Position ermittelt wird.

---

**HINWEIS**

 Das Intervall kann zwischen 0 und 24 Stunden eingestellt werden. Mit dem Setzen von "0" wird das GPS-Modul dauerhaft deaktiviert.

Beim Einschalten und im eingestellten Intervall wird das X-zone Com automatisch versuchen, GPS-Koordinaten zu ermitteln. Durch Setzen des Hakens in die Checkbox [Aktiv], wird unmittelbar eine Positionsbestimmung gestartet.



Abb. 5.13: Starten einer sofortigen Positionsbestimmung durch markieren der Checkbox.

Während der Positionsermittlung wechselt die Farbe der Beschriftung der Checkbox [Aktiv] zwischen grau und schwarz. Sind die GPS-Parameter ermittelt, stoppt dieser Farbwechsel und die ermittelten Positionsdaten werden angezeigt. Die Checkbox [Aktiv] ist aktiviert und der Zeitpunkt der Positionsfixierung "Erfasst am" wird gesetzt. Jetzt wird noch 1 Minute lang versucht, das Ergebnis zu präzisieren. Danach deaktivieren sich die Checkbox [Aktiv] und das GPS-Modul.

Jeder Versuch, eine Position zu bestimmen, wird nach 10 Minuten abgebrochen, falls keine Position ermittelt werden konnte. Danach schaltet sich das GPS-Modul aus, um Energie zu sparen. Falls aktuell keine Position ermittelt werden konnte, wird die zuletzt erfolgreich ermittelte weiterhin Position verwendet. Im Display des X-zone Com ist das GPS Symbol durchgestrichen (siehe Kap. 6.4.1).

## 5.4.2 Formular "Datenlogger"

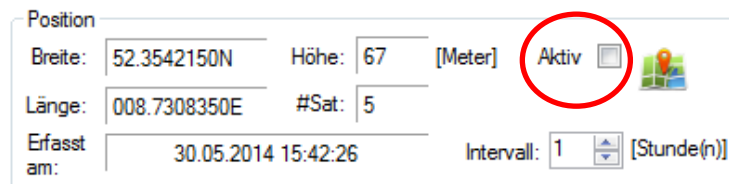
Das X-zone Com speichert alle vom X-zone 5x00 übertragenen Messwerte und Ereignisse. In welchem Intervall Messwerte übertragen werden sollen, ist konfigurierbar.

**HINWEIS**



 Alle vorgenommenen Einstellungen müssen einmal durch Anklicken von [Speichern] zum X-zone Com übertragen werden.

Abb. 5.14: Im Formular "Datenlogger" wird das Logging-Intervall festgelegt, lassen sich Statusinformationen zum Datenspeicher einsehen sowie der Datenspeicher leeren.

**Intervall:** Unter "Intervall" wird festgelegt, in welchen Zeitabständen Messwerte übertragen und gespeichert werden sollen. Dabei können entweder Sekunden (10-59 Sek.) oder Minuten (1-60 Min.) gewählt werden.

**Status:** Die Anzahl der gespeicherten Datensätze werden bei "Gesamt" und die Anzahl der noch nicht übermittelten Datensätze werden bei "ungelesen" dargestellt. Außerdem wird der Füllstand des Speichers angezeigt.

**HINWEIS**

 Der Datenlogger ist als Ringspeicher realisiert, d.h. wenn der Speicher voll ist, werden die ältesten Datensätze automatisch überschrieben.

**Datenlogger:** [Löschen] leert den Datenspeicher des Gerätes. Vor dem endgültigen Löschvorgang gibt es eine Sicherheitsabfrage.

### 5.4.3 Formular "GSM/GPRS"

Für eine erfolgreiche Datenkommunikation über das GSM/GPRS-Netz sind mehrere Einstellungen notwendig. Diese Verbindungsdaten sind abhängig vom verwendeten Mobilfunkprovider und müssen, falls nicht bekannt, dort erfragt werden.

**HINWEIS**

 Alle vorgenommenen Einstellungen müssen einmal durch Anklicken von [Speichern] zum X-zone Com übertragen werden.

Abb. 5.15: Mobilfunkeinstellungen. Die für die eingelegte SIM-Karte gültigen Einstellungen erfahren Sie von Ihrem Mobilfunk-Provider. Durch Klick auf [Modem Status] erhalten Sie Verbindungsparameter und es wird außerdem eine Funktionsprüfung durchgeführt

<b>APN</b>	<p>Access Point Name Ihres Mobilfunkbetreibers, einzutragen bei neu eingelegter SIM-Karte</p> <p>Hier einige Beispiele für Zugangspunkte in Deutschland (ohne Gewähr)</p> <table border="1"> <thead> <tr> <th>Betreiber</th> <th>APN-Zugangspunkt</th> <th>User</th> <th>Passwort</th> </tr> </thead> <tbody> <tr> <td>T-Mobile</td> <td>internet.t-mobile</td> <td>t-mobile</td> <td>tm</td> </tr> <tr> <td>Vodafone</td> <td>web.vodafone.de</td> <td>nicht nötig</td> <td>nicht nötig</td> </tr> <tr> <td>O2</td> <td>internet</td> <td>nicht nötig</td> <td>nicht nötig</td> </tr> <tr> <td>EPLUS</td> <td>internet.eplus.de</td> <td>eplus</td> <td>internet</td> </tr> </tbody> </table>	Betreiber	APN-Zugangspunkt	User	Passwort	T-Mobile	internet.t-mobile	t-mobile	tm	Vodafone	web.vodafone.de	nicht nötig	nicht nötig	O2	internet	nicht nötig	nicht nötig	EPLUS	internet.eplus.de	eplus	internet
Betreiber	APN-Zugangspunkt	User	Passwort																		
T-Mobile	internet.t-mobile	t-mobile	tm																		
Vodafone	web.vodafone.de	nicht nötig	nicht nötig																		
O2	internet	nicht nötig	nicht nötig																		
EPLUS	internet.eplus.de	eplus	internet																		
<b>Benutzer</b>	Benutzername für den Internetzugang																				
<b>Passwort</b>	Ihr Passwort für den Internetzugang																				
<b>Tel.</b>	Telefonnummer der eingelegten SIM-Karte. Wird manuell eingegeben																				
<b>PIN</b>	PIN-Nr. der in das Modem eingelegten SIM-Karte, falls diese über einen PIN-Schutz verfügt. Ansonsten bleibt das Feld leer. Wird benötigt beim einschalten/hochfahren des Gerätes.																				

Durch Anklicken von [Modem Status] öffnet sich ein Informationsfenster und das Modem versucht, eine Verbindung zum Netzwerk herzustellen.

Sobald eine IP-Adresse angezeigt wird, war die Funktionsprüfung des Modems erfolgreich.



Abb. 5.16: Das Fenster zum Modem-Status informiert Sie über die Verbindungsparameter. Die Telefonnummer wird nur angezeigt wenn sie zuvor im Eingabefeld manuell eingegeben wurde.

#### 5.4.4 Formular "E-Mail"

Das X-zone Com versendet konfigurierbar zyklisch E-Mails mit Messwerten. Im Falle eines Alarms erfolgt der Versand unverzüglich. In beiden Fällen werden alle noch nicht übertragenen Mess- und Alarmwerte versendet.

HINWEIS

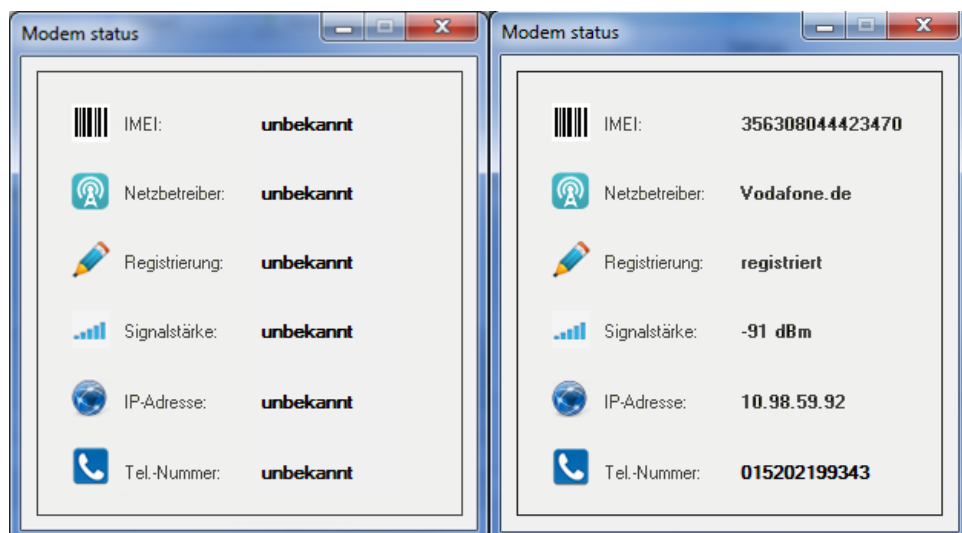
Alle vorgenommenen Einstellungen müssen einmal durch An-  
klicken von [Speichern] zum X-zone Com übertragen werden.

Abb. 5.17: E-Mail Einstellungen wie SMTP-Server, Sende- und Empfängeradressen, Sendeintervall und bei welchen Alarmen zusätzlich eine E-Mail gesendet werden soll.

**SMTP:** Die für den E-Mail-Versand und die Verwendung der Mcloud notwendigen Einstellungen werden unter "SMTP" vorgenommen.

<b>Server</b>	Adresse Ihres Postausgangsservers
<b>Benutzer</b>	Benutzername für den E-Mail Zugang
<b>Passwort</b>	Ihr Passwort für den E-Mail Zugang

**Adresse:** Die Sender-/Empfänger-Adressen werden unter "Adresse" eingetragen.

<b>Von</b>	Absenderadresse (Benutzerdefiniert nach Maßgabe des Providers)
<b>An</b>	E-Mail-Empfänger (max. 1 Empfänger).
<b>Kopie</b>	E-Mail-Empfänger (max. 1 Empfänger der Kopie).

**Sendeintervall:** Unter "Sendeintervall" stellen Sie das Zeitintervall der Versendungen ein (5/10/15/30 Min; 1/2/3/4/6/8/12 Std.; 1 Tag). Nach dem Speichern erfolgt der erste E-Mail Versand nach Ablauf des eingestellten Intervallzeitraumes.

Mit Markieren der Checkbox "Mcloud" werden die Daten zur Mcloud übertragen (siehe gesonderte Bedienungsanleitung zur Nutzung der Mcloud).

**E-Mail senden bei:** Unter "E-Mail senden bei" können Sie konfigurieren, bei welchen Alarmbedingungen der E-Mail-Versand und die Übertragung in die Mcloud sofort ausgelöst werden sollen.

Prüfen Sie die Providerdaten und Empfängeradressen, in dem Sie eine Funktionsprüfung (siehe Kap. 6.5) durchführen. Dabei wird die Versendung einer E-Mail sofort ausgelöst.

## 5.4.5 Formular "SMS"

Das X-zone Com kann so konfiguriert werden, dass es im Falle von Alarmen SMS an benutzerdefinierte Telefonnummern versendet. Ferner hat der Benutzer die Möglichkeit, per SMS den aktuellen Status abzufragen sowie Anweisungen an das X-zone Com zu senden (siehe Kap. 7).

**HINWEIS**

Alle vorgenommenen Einstellungen müssen einmal durch An-  
klicken von [Speichern] zum X-zone Com übertragen werden.

Abb. 5.18: Einstellungen für den Versand von SMS. Hier bestimmen Sie den zu sendenden SMS-Inhalt im Falle eines Alarms. Ganz rechts vergeben Sie den "Lesen"-PIN und den "Ausführen"-PIN.

Im Formular „SMS“ können bis zu vier SMS Empfänger bestimmt werden, die im Alarmfall informiert werden. Zum Hinzufügen klicken Sie auf [Hinzufügen] und geben die Nummer ein. Mit [Entfernen] entfernen Sie eine markierte Telefonnummer. Wird keine Nummer vergeben ist die SMS Funktionalität ausgeschaltet. Weiterhin besteht die Möglichkeit, die maximale Anzahl an zu versendenden SMS pro Tag festzulegen (1..99 SMS pro Tag). Dazu muss die Checkbox [Max. Alarmer/Tag] markiert sein. Wird die Checkbox deaktiviert ist die Anzahl der zu versendenden SMS Nachrichten unbegrenzt.

**SMS-Inhalt:** Unter "SMS-Inhalt" können Sie eine Zeichenfolge als Präfix festlegen (nicht zulässig Zeichen sind: „\$“, „°“, deutsche Umlaute und „ß“), die in jeder Alarm-SMS nach dem Gerätenamen folgt. Außerdem können Sie wählen, ob auch der aktuelle Messwert und die ID des alarmgebenden X-zone 5x00 in der Alarm-SMS enthalten sein soll oder nur der Alarmtyp und die Gasart.

**SMS senden bei:** Unter "SMS senden bei" bestimmen Sie, bei welcher Alarmbedingung eine SMS versendet wird.

Alarmtyp	Bedeutung	
<b>A1</b>	Konzentrationsvoralarm	<b>Besonderheit:</b> beim Gastyp O2 = Sauerstoffmangel
<b>A2</b>	Konzentrationshauptalarm	<b>Besonderheit:</b> beim Gastyp O2 = Sauerstoffüberschuss
<b>Gerätefehler</b>	Gerätefehler am X-am 5x00 oder X-zone 5x00. Das Gerät oder mehrere Sensorkanäle sind nicht betriebsbereit. Gemeldete Gerätefehler des X-zone Com in Kap. 10.1.	

**HINWEIS**

Lesen Sie die genaue Bedeutung der Alarmtypen in der Ge-  
brauchsanweisung des X-am 5x00 nach.

**PIN:** Für Anfragen per SMS, die das X-zone Com als gültig akzeptieren soll, können Sie zwei PINs vergeben. Diese müssen in der SMS an das X-zone Com enthalten sein. Für rein lesende Aktionen wird der "Lesen-PIN", für lesende und weiterführende Aktionen, die z.B. die aktuelle Situation beeinflussen, muss der "Ausführen-PIN" enthalten sein. Das X-zone Com reagiert ausschließlich auf SMS mit korrekter PIN und ignoriert alle anderen. Eine ausführliche Beschreibung der möglichen SMS findet sich in Kap. 7.

Prüfen Sie die eingegebenen Telefonnummern, in dem Sie eine Funktionsprüfung (siehe Kap.6.5) durchführen. Sofern bei mindestens einer der drei Alarmbedingungen eine SMS gesendet werden soll, wird bei der Funktionsprüfung die Versendung einer Alarm-SMS sofort ausgelöst.

Beispiel einer Alarm-SMS:





Abb. 5.19: Beispiel einer versendeten Alarm-SMS. Es sendet das X-zone Com "Test\_7" einen A2 Alarm bei CO2 und einen A1 Alarm bei Sauerstoff, gemessen vom X-zone Gruppengerät mit der ID 1.

**HINWEIS**

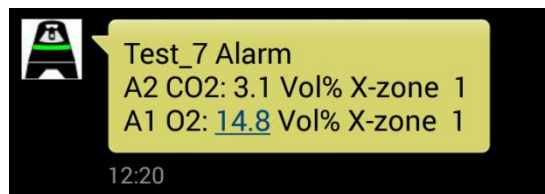

Eine Antwort-SMS erhält nur derjenige SMS Teilnehmer der die Anfrage versendet hat.

### 5.4.6 Formular "Status"

Das Formular „Status“ zeigt für die aufgeführten Hardware und Funktionsbereiche des verbundenen X-zone Com den aktuellen Status an. Ein vorgesetzter grüner Haken signalisiert die Betriebsbereitschaft.



Abb. 5.20: Volle Betriebsbereitschaft des X-zone Com

Im Falle eines Gerätefehlers oder Störung wird dieses durch ein rotes Kreuz signalisiert. Ein Klick auf dem dann vorangestellten Pluszeichen im Verzeichnisbaum öffnet eine detailliertere Meldung.

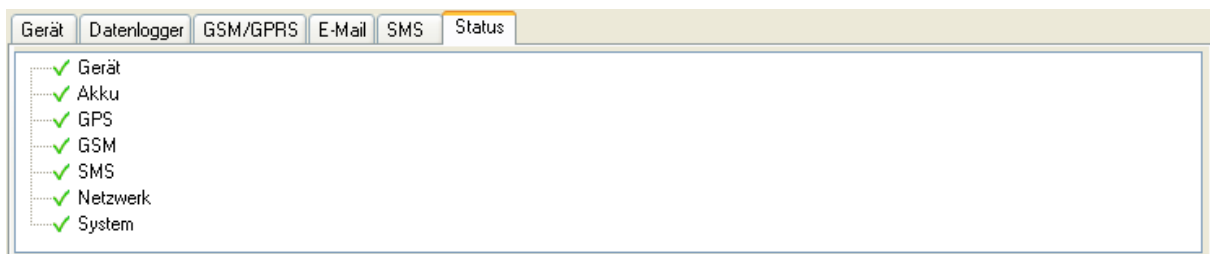

Abb. 5.21: Zwei Fehler traten auf.

## 5.5 MESSWERTEBEREICH

Der Messwertebereich zeigt die aktuellen Messwerte und Alarme.

Aktuelle MAXIMALE Sensorwerte (das verbundene Gerät ist kein Master)				
X-zone ID	Gastyp	Wert	Einheit	Alarmtyp
0	O2	20,9	Vol%	A1
0	H2S	0	ppm	
0	CO	0	ppm	
0	CO2	0,25	Vol%	A2
0	ch4	0	%LEL	
1	ch4	0	%UEG	

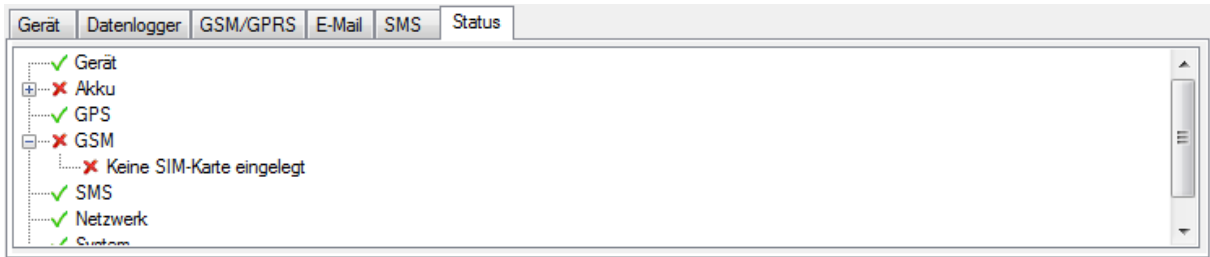
Abb. 5.22: Messwerte und Alarme im Messwertebereich der Manager Software. Beide anliegende Alarme wurden durch das Gruppengerät 0 ausgelöst.

Die Tabelle zeigt für jeden Messwert die Identifikationsnummer des X-zone 5x00 in der Gruppe, den Gastyp, die aktuelle Gaskonzentration und Einheit sowie den Alarmtyp, falls ein Alarm vorliegt.

Aus dem oberhalb der Tabelle stehenden Text läßt sich entnehmen, ob das verbundene X-zone 5x00 Teil eines offenen oder geschlossenen Netzwerks (Gruppe) ist, und der Messwert somit ein lokaler Wert oder ein Maximalwert aus der Gruppe ist (siehe Kap. 4.2.4).

Überschrift	Bedeutung
Aktuelle, LOKALE Sensorwerte (keine geschlossenen Gruppe konfiguriert)	<b>Offenes Netzwerk:</b> Angezeigt werden die Sensorwerte des lokal am X-zone Com angeschlossenen X-zone 5x00.
Aktuelle MAXIMALE Sensorwerte (das verbundene Gerät ist kein Master)	<b>Gruppe:</b> Maximale Messwerte der im Netzwerk aktuell gemessenen Gasarten
Aktuelle MAXIMALE Sensorwerte	<b>Gruppe:</b> Maximale Messwerte der im Netzwerk aktuell gemessenen Gasarten
Nicht mit X-zone 5x00 verbunden	Keine Verbindung zum X-zone



## 6 BEDIENUNG AM X-ZONE COM

Im Folgenden wird die Bedienung des X-zone Com erläutert.

### 6.1 BEDIENFELD

Das X-zone Com besitzt ein OLED-Display, auf dem die wichtigsten Informationen dargestellt werden, und zwei - mit einem Magnetstift zu bedienende - Tasten.





Abb. 6.1: X-zone Com Bedienfeld

Die Tasten sind wie folgt belegt:

	<b>ON/OFF-Taste</b> zum Ein- und Ausschalten des Gerätes	<b>Langes Halten</b> ON (ca. 3 Sek.) OFF (ca. 3 Sek.)
	<b>Funktionstaste</b>	<b>Langes Halten</b> Funktionsprüfung durchführen <b>Kurzes Antippen</b> Wechseln zur nächsten Bildschirmseite, wenn Fehler vorliegen. Während einer Funktionsprüfung, beendet das kurze Antippen die Funktionsprüfung..

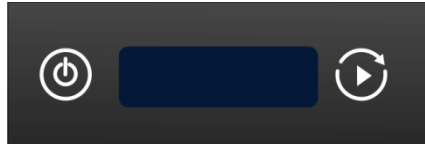
### 6.2 GERÄT EINSCHALTEN

Um das X-zone Com einzuschalten, betätigen Sie die linke Taste (ON/OFF) mit dem Magnetstift ca. 3 Sek. Auf dem Display wird dabei von 3 heruntergezählt.



Abb. 6.2: Countdown beim Einschalten.

#### VORSICHT

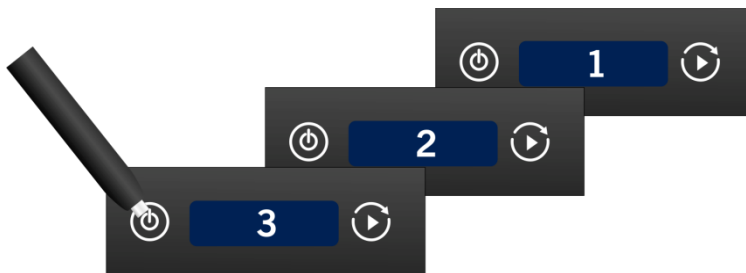

Das X-zone Com darf ausschließlich in den angegebenen Temperaturbereichen betrieben werden.

Beim Einschalten wird das X-zone Com automatisch versuchen, sich im GSM-Netzwerk einzubuchen und die GPS-Koordinaten zu ermitteln. Mit leerem Akku lässt sich das X-zone Com nicht einschalten.

Falls keine SIM-Karte im Modem enthalten ist wird der Fehler x21 „no SIM card“ generiert.

## 6.3 GERÄT AUSSCHALTEN

Um das X-zone Com auszuschalten, betätigen Sie die linke Taste (ON/OFF) mit dem Magnetstift ca. 3 Sek. Auf dem Display wird währenddessen von 3 heruntergezählt.



Abb. 6.3: Countdown beim Ausschalten.

Bei leerem Akku schaltet sich das X-zone Com selbstständig ab.

## 6.4 DISPLAYANZEIGEN

Die Displayanzeige ist aufgeteilt in zwei Bereiche.

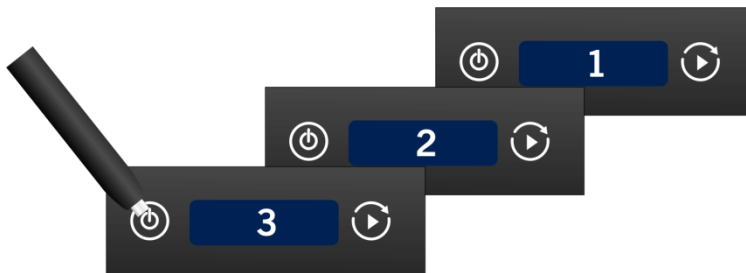
- Linker Bereich: Statusanzeige für einzelne Funktionen oder Aktionen.
- Rechter Bereich: Gesamtstatusanzeige.



Abb. 6.4: Displayanzeige am X-zone Com.

### 6.4.1 Übersicht Symbole

Der Gesamtstatus wird durch folgende Symbole beschrieben.

Symbol	Bedeutung	Symbol	Bedeutung
	Aktuell liegen keine Fehler vor. Alle Aktionen der Funktionsprüfung wurden erfolgreich abgeschlossen.		Status der letzten Aktion: X-zone Com Gerätefehler trat auf.
	Mindestens eine Aktion laufend (z.B. Verbindungsaufbau, SMS-Versand, Positionsermittlung).		

Die Bedeutungen der Symbole für einzelne Funktionen werden in der folgenden Tabelle erläutert.

Symbol	Bedeutung	Symbol	Bedeutung
	Datenübermittlung zur ORI Mcloud aktiviert!		

	<b>Blinkend:</b> Daten werden versendet.		
	E-Mail Versand zu mindestens einem Empfänger aktiviert. <b>Blinkend:</b> E-Mail wird versendet.		E-Mail-Versand und Übermittlung in die Mcloud nicht möglich / abgebrochen.
	SMS erfolgreich versendet / aktiviert. <b>Blinkend:</b> SMS wird versendet.		SMS konnte nicht gesendet werden.
	Akku vollständig geladen <b>Zyklisch ansteigende Akkufüllung im Display:</b> Akku wird geladen		Akku leer - das Gerät kann sich jeden Moment ausschalten
	GPS Position erfolgreich ermittelt. <b>Blinkend:</b> Ermittlung der Koordinaten.		Kein GPS (abgeschaltet oder Empfang nicht möglich)
	Signalstärke ca. 100%		
	Signalstärke ca. 20% <b>Blinkend:</b> Einbuchung im GSM-Netzwerk zur Zeit aktiv.		Keine Verbindung zum GSM-Netzwerk

**Beispiel:**

1.		Der Akku ist noch zu ca. 75% geladen, die Signalstärke beträgt ca. 100%, die Verbindung zur Mcloud und die E-Mail-Funktionen sind aktiviert, GPS-Koordinaten wurden ermittelt. Der Gesamtstatus ist OK.
----	--	---

### 6.4.2 Fehleranzeigen

Verschiedene Fehler können am Display angezeigt werden. Eine Fehlertabelle findet sich in Kap. 10.1. Sie enthält für jeden Fehler eine Beschreibung und eine Handlungsempfehlung. Durch Betätigen der rechten Taste wird zwischen den Fehleranzeigen gewechselt.



Abb. 6.5: Beispiel eines aufgetretenen Fehlers mit Fehlernummer und Kurzbeschreibung

**Beispiele:**

	SMS und E-Mail wurden bei der Funktionsprüfung nicht versendet. Das versenden von Daten in die Mcloud, ist in diesem Beispiel nicht aktiviert.
	<b>Mögliche Ursachen:</b>
	<ul style="list-style-type: none"> <li>• Ungültige Telefonnummer</li> <li>• Fehlerhafte E-Mail Adresse bei "to" und "copy to"</li> </ul>

## 6.5 FUNKTIONSPRÜFUNG DURCHFÜHREN

Die Funktionsprüfung dient dazu, die Sende- und Empfangseinstellungen und die Funktionsfähigkeit des X-zone Com sowie den GSM- und GPS-Empfang zu prüfen. Außerdem wird sofort eine Positionsermittlung gestartet.

Die Funktionsprüfung wird durch Betätigen der rechten Bedientaste  (3 Sek.) des X-zone Com ausgelöst. Die folgenden Aktionen werden dann ausgeführt:

- GPS aktivieren, Koordinaten und Uhrzeit ermitteln.
- Modem ins Funknetz einbuchen, APN Zugang erstellen, IP-Adresse ermitteln.
- E-Mail an eingetragene E-Mail-Empfänger mit allen bis dahin nicht versendeten Daten senden
- Alle bis dahin nicht versendeten Daten in die Mcloud übertragen, sofern die Mcloud-Funktion aktiviert ist
- Senden einer SMS an alle eingetragenen Telefonnummern, sofern bei mindestens einer Alarmbedingung eine SMS gesendet werden soll.

Statusinformationen werden im Display angezeigt (SMS-Versand, E-Mail und Cloud, Positionsermittlung). Solange eine Aktion noch nicht abgeschlossen ist, blinkt das Symbol.

Treten Fehler auf, wird im rechten Bereich des Displays das entsprechende Fehlersymbol angezeigt. Weitere Informationen zu den Fehlern lassen sich in der Manager Software unter dem Formular "Status" (Kap.5.4.6) einsehen.



Sind SMS und Email versendet und die Position erfolgreich ermittelt worden, erscheint das links dargestellte Display.

Durch Betätigung der linken Schaltfläche wechselt die Anzeige wieder zum Statusbildschirm.

### HINWEIS



*Während des Funktionstestes ist die linke-Bedientaste des X-zone Com eingeschränkt. Es ist nur noch ein Ausschalten des Gerätes möglich.*

## 7 SMS AN DAS X-ZONE COM

Das X-zone Com bietet dem Benutzer die Möglichkeit, per SMS den aktuellen Status abzufragen sowie Anweisungen an das X-zone Com zu senden. Bei der Anfrage via SMS müssen Sie folgende Struktur verwenden.

[PIN] Kommando

Bei der einzugebenden [PIN] (personal identification number) handelt es sich um die von Ihnen in der Manager Software vergebene "Lesen-PIN" für rein lesende Aktionen bzw. um die "Ausführen-PIN" für die lesenden und weiterführenden Aktionen, die z.B. die aktuelle Situation beeinflussen (siehe Kap.5.4.5). Die PIN verhindert, dass SMS von Unbefugten vom X-zone Com akzeptiert werden.

Eine falsche PIN-Eingabe erzeugt eine Fehlermeldung direkt am Gerät. Eine SMS-Antwort erfolgt in diesem Fall nicht.



Abb. 7.1: Fehlermeldung am Gerät bei verwenden einer falschen SMS-PIN.

Das Kommando kann groß- oder kleingeschrieben werden. Ein an das Kommando angehängtes Fragezeichen ist zulässig.

Die SMS-Antworten sind in den folgenden Abschnitten im Detail beschrieben.

PIN	Kommando	Antwort
<b>[Lesen-PIN]</b>	Stat	Geräteinformationen
	Group	Gruppeninformation
	Local	lokale Messwerte des direkt mit dem X-zone Com verbundenen X-zone 5x00
	Max	Maximalwerte der im geschlossenen Netzwerk gemessenen Gase
	Alarm	Aktuelle Alarmwerte
<b>[Ausführen-PIN]</b>	Ack	Alarmquittierung
	Evac	Evakuierungsalarm ein
	Evac off	Evakuierungsalarm aus
	GPS	Letzte bekannten GPS Koordinaten

## 7.1 LESENDE SMS-BEFEHLE

Die lesenden SMS-Befehle können mit der "Lesen-PIN" oder auch mit der "Ausführen-PIN" übermittelt werden.

### 7.1.1 Statusabfrage

[PIN] stat

Inhalt der Antwort-SMS	Wertebereich
Gerätename des X-zone Com	Benutzerdefinierte ASCII-Zeichenfolge
Verbindungsstatus zum X-zone 5x00	"X-zone connected" "X-zone not connected"
GSM RSSI level [-dBm]	-100 bis 0
X-zone Com Batteriespannung [V]	12 bis 13,5 V (max 15V)
X-zone 5x00 Batteriespannung [V]	5 bis 7 V
Verwendung von E-Mail Alarmierung	ON/OFF
Eingestelltes Sendeintervall für E-Mails und für die Übermittlung der Daten in die Mcloud	5/10/15/30 Min; 1/2/3/4/6/8/12 Std;. 1 Tag

Beispiel:



Abb. 7.2: Bildschirmsicht eines Smartphone nach Abfrage des Status per SMS.

A) Antwort bei fehlender Verbindung zum X-zone 5x00.

B) Antwort bei existierender Verbindung zum X-zone 5x00.

Unterschiedliche Schreibweisen des Kommandos sind zulässig.

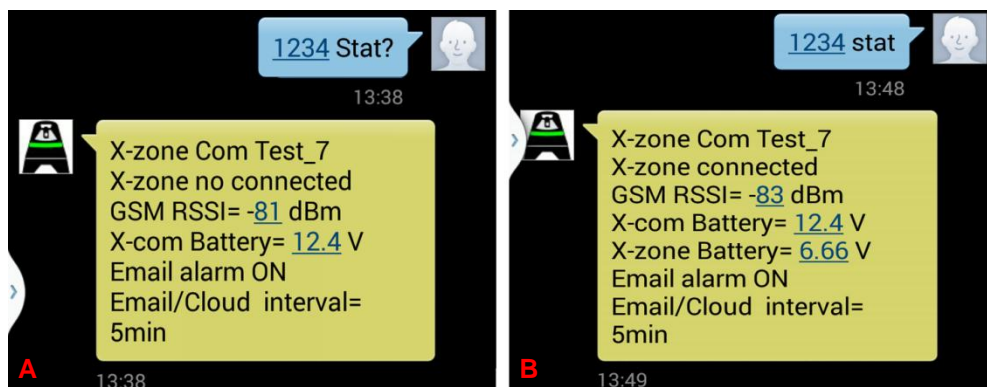
## 7.1.2 Abfrage von Informationen zum Gruppenstatus

Mit dem Kommando "group" lassen sich Informationen über die Gerätegruppe oder einem ungruppierten Gerät in einem offenen Netzwerk abfragen.

### [PIN] group

Inhalt der Antwort-SMS	Wertebereich
Gerätename des X-zone Com	Benutzerdefinierte ASCII-Zeichenfolge
Gruppenstatus des Gerätes	„Main device“ „group device“ „ungrouped“
Gruppengröße, sofern an das Hauptgerät angeschlossen	2 bis 15
Alarmzustand	No alarm, A1, A2, device error
Anzahl der überwachten Gase (der Gruppe oder vom lokal angeschlossenen X-zone 5x00)	0 bis 8

### Beispiel: Antwort bei einer Gruppe



Abb. 7.3: Bildschirmansicht eines Smartphone nach Abfrage des Gruppenstatus.

**A)** Bei dem antwortenden Gerät handelt es sich um das Hauptgerät (ID=0). Die Gruppe besteht aus 2 Geräten und überwacht insgesamt 4 Gase. Ein A1 Alarm liegt vor.

**B)** Das X-zone Com ist am Gruppengerät mit der ID 1 angeschlossen. Von der Gruppe werden insgesamt 6 Gase überwacht. Ein Alarm liegt nicht vor.

## Beispiel: Antwort von einem lokalen Gerät

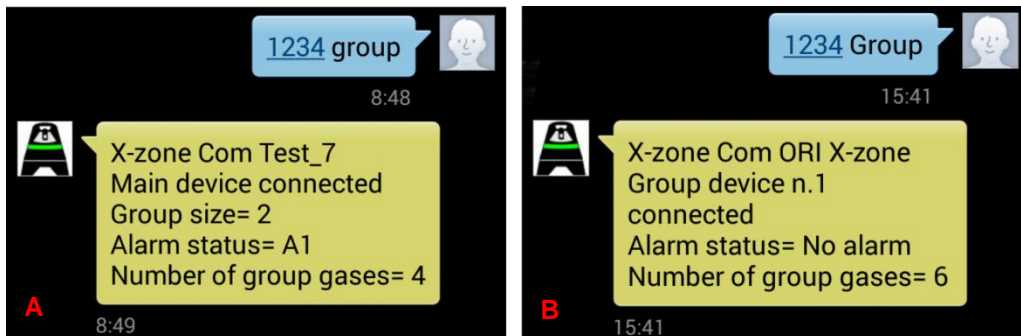

Abb. 7.4: Bei dem antwortenden Gerät handelt es sich um ein ungruppiertes, lokales Gerät welches insgesamt 3 Gase überwacht.

### 7.1.3 Messwerte des lokal angeschlossenen X-zone 5x00

Bei der SMS-Anfrage "Local" werden die aktuellen Messwerte des direkt mit dem X-zone Com verbundenen X-zone 5x00 übermittelt, unabhängig davon, ob dieses Teil einer Gruppe ist oder nicht.

#### [PIN] local

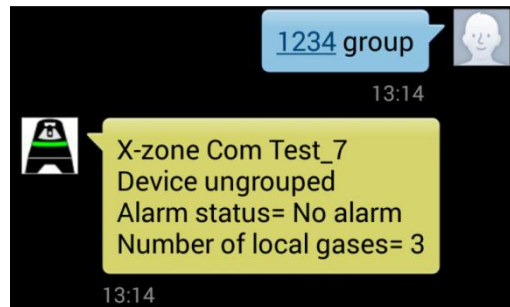
Inhalt der Antwort-SMS	Wertebereich
Gerätename des X-zone Com	Benutzerdefinierte ASCII-Zeichenfolge
Gasart	Kurzgasnamen des X-am 5x00
Konzentrationswert	0 bis 10.000
Einheit	Vol%, %UEG, %LEL, %LIE, ppm, mg/m3, ppb, mbar, hPa, kPa, mg/L
Alarmtyp	A1, A2
Identifikationsnummer	Seriennummer des X-zone 5x00

#### Beispiel:



Abb. 7.5: Bildschirmansicht eines Smartphone nach dem Senden von "1234 local". Im Beispiel misst das mit dem X-zone Com "ORI X-zone" verbundene X-zone "AREH-0003" 5 Gase. Für CO<sub>2</sub> liegt ein A2 für O<sub>2</sub> ein A1-Alarm vor.



### 7.1.4 Abfragen der maximalen Messwerte in einer Gruppe

Das X-zone Com übermittelt eine Liste, die für jedes von der Gruppe gemessene Gas den aktuell gemessenen maximalen Wert enthält, einschließlich eines evtl. vorhandenen Alarmtyps und der Geräte-ID. Für Sauerstoff ist der angezeigte Wert der minimale Wert.

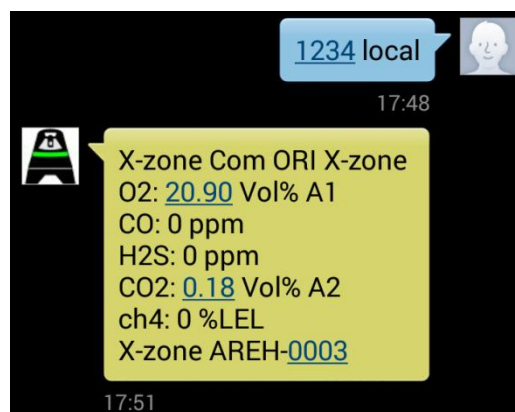
**[PIN] max**

Inhalt der Antwort-SMS	Wertebereich
Gerätename des X-zone Com	Benutzerdefinierte ASCII-Zeichenfolge
Gasart	Kurzgasnamen des X-am 5x00
Konzentrationswert	0 bis 10.000
Einheit	Vol%, %UEG, %LEL, %LIE, ppm, mg/m <sup>3</sup> , ppb, mbar, hPa, kPa, mg/L
Alarmtyp	A1, A2
Identifikationsnummer des X-zone 5x00 in der Gruppe welches den max. Wert gemessen hat	0 bis 15

**Beispiel:** Maximalwerte



Abb. 7.6: Bildschirmansicht eines Smartphone nach Abfrage der Maximalwerte aller von der Gruppe überwachten Gase. Im Beispiel wird der ch4-Wert vom Gruppengerät mit der ID=1 gemessen. Die anderen Gase vom Hauptgerät mit der ID=0. Für O<sub>2</sub> und CO<sub>2</sub> liegen jeweils ein A1 bzw. ein A2-Alarm.



Abb. 7.7: Bildschirmansicht eines Smartphone, falls es sich bei dem angeschlossenen X-zone 5x00 um kein Gruppengerät handelt. Verwenden Sie in diesem Fall den Befehl "local".

## 7.1.5 GPS-Koordinaten anzeigen

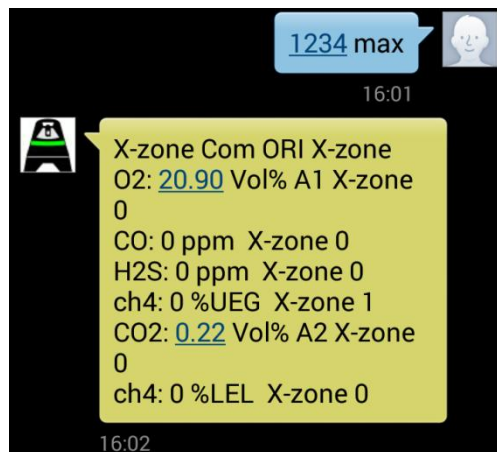
Die Antwort-SMS enthält die letzte bekannte Position des X-zone Com.

### [PIN] GPS

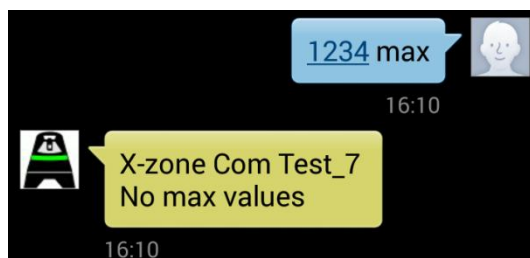
Inhalt der Antwort-SMS	Wertebereich
Gerätename des X-zone Com	Benutzerdefinierte ASCII-Zeichenfolge
Koordinaten	Breitengrad, Längengrad
Höhe	Ungefähre Höhe über den Meeresspiegel (Mean Sea Level)
Datum und Zeit der letzten erfolgreichen Positionsermittlung	Datum und Uhrzeit

Die angezeigte Zeit setzt sich aus der "Universal Time Coordinated [UTC]" und der lokalen Zeitabweichung zusammen, z.B. in Mitteleuropa:

- Normal: UTC+1
- Sommerzeit: UTC+2

**Beispiel:**



Abb. 7.8: Bildschirmansicht eines Smartphone nach Anfrage der Position. Im Beispiel wurden die Koordinaten zuletzt um 08:05 Ortszeit ermittelt (UTC+1). Die SMS-Abfrage erfolgte 09:18 Ortszeit.

## 7.1.6 Abfrage von aktuellen Alarmen

Es wird eine Liste der aktuellen Alarme zugesendet. Die Liste kann Gasalarme und Gerätefehler enthalten. Bei einem Gasalarm werden folgende Angaben übermittelt: Gasart des Alarm auslösenden Gases, der aktuelle Messwert und Einheit sowie an welchem X-zone 5x00 der Alarm vorliegt. Bei Gerätefehlern wird übermittelt, an welchem X-zone 5x00 der Fehler vorliegt, aber kein Fehlercode.

Die Struktur der SMS-Antwort ist abhängig von Ihren Einstellungen in der Manager Software.

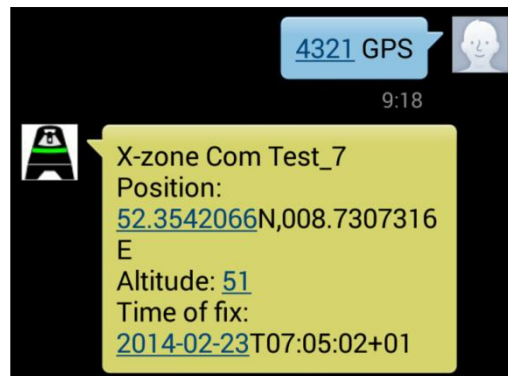
Abb. 7.9: Festlegung der SMS-Antwortstruktur innerhalb der Manager Software.

### [PIN] Alarm

#### Im Falle eines Gasalarms (A1, A2)

Inhalt der Antwort-SMS	Wertebereich
Gerätename des X-zone Com	Benutzerdefinierte ASCII-Zeichenfolge
Präfix	Benutzerdefinierte ASCII-Zeichenfolge
Alarmtyp	A1, A2
Gasart	Kurzgasnamen des X-am 5x00
Konzentrationswert (optional)	0 bis 10.000
Einheit (optional)	Vol%, %UEG, %LEL, %LIE, ppm, mg/m3, ppb, mbar, hPa, kPa, mg/L
ID des X-zone 5x00 (optional)	0 bis 15 oder Seriennummer des X-zone 5x00

#### Im Falle eines X-zone 5x00 Gerätefehlers

Inhalt der Antwort-SMS	Wertebereich
Gerätename des X-zone Com	Benutzerdefinierte ASCII-Zeichenfolge
Präfix	Benutzerdefinierte ASCII-Zeichenfolge
Alarmtyp	“Device alarm”
ID des X-zone 5x00 (optional)	0 bis 15 oder Seriennummer des X-zone 5x00

## Beispiele: Alarme



Abb. 7.10: Bildschirmansicht eines Smartphone nach einer Alarmanfrage. Angefragt wurde das X-zone Com "Test\_7". Es liegt ein A1 Alarm beim Sauerstoff vor. Bei dem folgenden Sauerstoffwert handelt es sich um den zurzeit gemessenen O2-Wert und nicht um den Wert, der zum Alarm geführt hat.

Ausgelöst wurde der Alarm bei

- A. durch das "X-zone 0" (0=Hauptgerät), bei
- B. durch das "X-zone 1" (1=Gruppengerät).

### HINWEIS

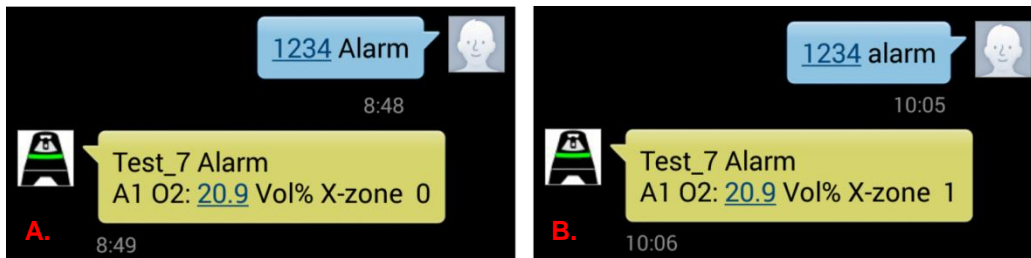

Im Falle eines zuvor bestätigten Alarms erhalten Sie beim Versenden des Befehls PIN Alarm die Meldung "All alarms stopped".

## 7.2 AUSFÜHRENDE SMS-BEFEHLE

**HINWEIS**

 Sie benötigen für die ausführenden SMS-Befehle die in der Manager Software festgelegte "Admin-PIN".

### 7.2.1 Alarmquittierung

Das Verhalten des X-am 5x00 bei einer Alarmquittierung hängt von seiner Konfiguration ab. Alarmer können quittierbar oder nicht quittierbar und selbsterhaltend oder nicht selbsterhaltend sein. Lesen Sie bitte daher sorgfältig die Gebrauchsanleitung Ihres Gasmessgerätes Dräger X-am 5x00 durch.

**HINWEIS**

 Eine Quittierung aller Alarmer führt nicht zwingend dazu, dass kein Alarm mehr signalisiert wird. Das Verhalten des Systems hängt von der Alarmsituation und der Konfiguration des X-am 5x00 ab.

Die SMS-Antwort enthält neben dem Gerätenamen des X-zone Com einen Bestätigungstext, dass die Alarmer quittiert wurden.

#### [Admin-PIN] ack

Inhalt der Antwort-SMS	Wertebereich
Gerätename des X-zone Com	Benutzerdefinierte ASCII-Zeichenfolge
Bestätigungstext	"Alarms acknowledged"

#### Beispiel:



Abb. 7.11: Bildschirmansicht eines Smartphone nach dem Senden der Alarmquittierung.

### 7.2.2 Evakuierungsalarm aktivieren

Der Benutzer kann mit einer SMS einen Alarm auslösen, der vom X-zone 5x00 Netzwerk als A2-Alarm signalisiert wird. Dieser wird Evakuierungsalarm genannt, da er üblicherweise der Evakuierung eines Bereichs dient.

## [Admin-PIN] evac

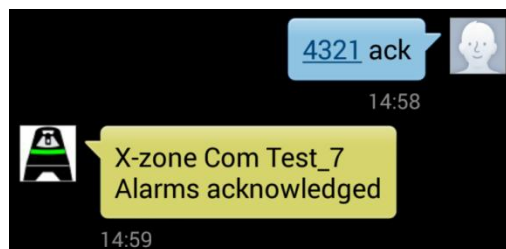
Inhalt der Antwort-SMS	Wertebereich
Gerätename des X-zone Com	Benutzerdefinierte ASCII-Zeichenfolge
Bestätigungstext	“Evacuation alarm”

Beispiel:





Abb. 7.12: Bildschirmansicht eines Smartphone nachdem ein Evakuierungsalarm ausgelöst wurde.

**HINWEIS**

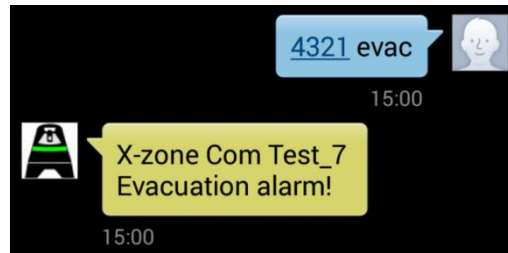

Bei einem Evakuierungsalarm erscheint bei allen X-am 5x00 in der Gruppe im Display das Evakuierungssymbol.

## 7.2.3 Evakuierungsalarm beenden

Der Evakuierungsalarm kann per SMS oder durch Ausschalten des X-zone Com beendet werden.

### [Admin-PIN] evac off

Inhalt der Antwort-SMS	Wertebereich
Gerätename des X-zone Com	Benutzerdefinierte ASCII-Zeichenfolge
Bestätigungstext	“Evacuation alarm stopped”

Beispiel:



Abb. 7.13: Bildschirmansicht eines Smartphone nachdem der Evakuierungsalarm zurückgesetzt wurde.

## 8 KURZÜBERSICHT M-CLOUD

Die Funktionalität der ORI Mcloud und ihre Verwendung werden In diesem Kapitel kurz erläutert. Detaillierte Informationen zur ORI Mcloud finden Sie im zugehörigen Handbuch.

Die Mcloud ist ein Internet-Datenportal, von dem Sie die Daten Ihrer X-zone Com mit Hilfe eines WEB-Browsers abfragen und darstellen können. Neben dem allgemeinen Gerätestatus, dem Akkufüllstand und dem letzten Sendezeitpunkt, sehen Sie alle Messwertverläufe und Alarmwerte. Der Zeitraum für die Messreihen ist auswählbar. Die grafisch dargestellten Daten können Sie in eine CSV-Datei exportieren und auf Ihren PC herunterladen, wo die Dateien beispielsweise mit Microsoft Excel sich öffnen und weiterverarbeiten lassen. Weiterhin können Sie die Position Ihrer X-zone Com Geräte in einer Karte anzeigen lassen.

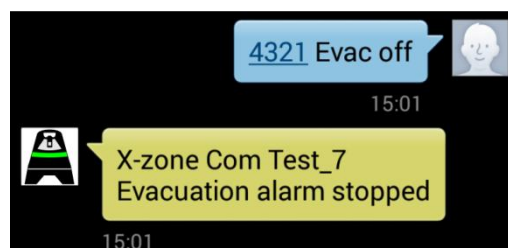
Für den Zugriff auf die Mcloud benötigen Sie einen Internet-Zugang, einen WEB-Browser und – nach Ablauf von 4 Wochen – eine Lizenz, die Sie pro Gerät erwerben. Die vier für Sie kostenfreien Wochen beginnen, sobald Sie das Gerät registriert haben. Nach Ablauf dieser Zeit können Sie zeitlich begrenzte Lizenzen erwerben. Ist die Lizenz eines X-zone Com gültig, können beliebig viele Messwerte abgespeichert werden. Vor Ablauf einer Lizenz werden Sie mit einem Warnsymbol innerhalb der Geräteliste rechtzeitig auf diesen Umstand hingewiesen

Die Daten Ihres X-zone Com werden innerhalb Deutschlands auf einem TÜV geprüften Server gemäß "Trusted Site TSI V3.0 Level 1" gespeichert. Der Zugriff via Browser ist Passwort geschützt und erfolgt über das sichere Hypertext-Übertragungsprotokoll HTTPS.

### 8.1 M-CLOUD GERÄTELISTE

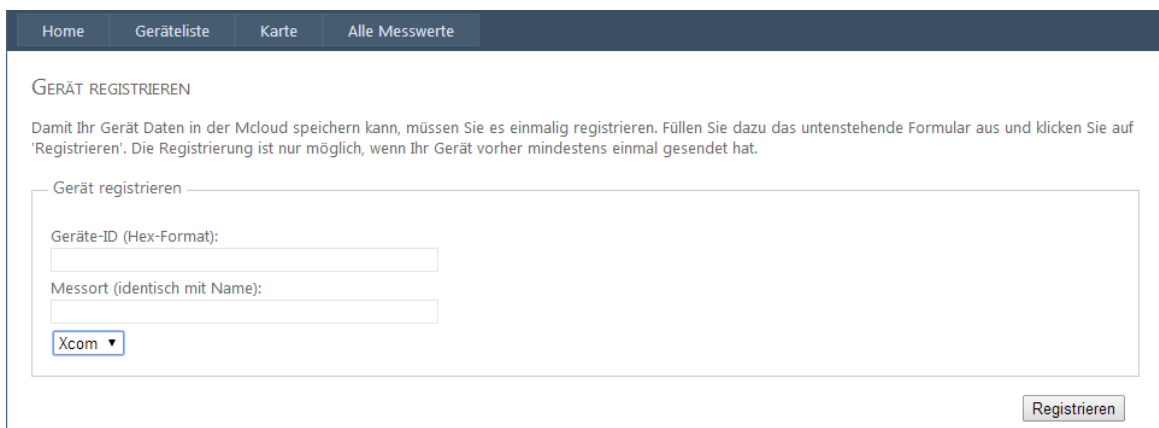

In der Geräteliste werden alle ihre registrierten Geräte angezeigt. Falls Ihr Gerät nicht angezeigt wird muss es noch in der Mcloud registriert werden (siehe Abb. 8.2). Eine Registrierung ist nur möglich, wenn Ihr Gerät vorher mindestens einmal gesendet hat. Um Messdaten zur Mcloud zu übertragen, dürfen Sie daher nicht vergessen mit Hilfe der Manager Software die Cloud-Funktionalität zu aktivieren (siehe Kap. 5.4.4).



The screenshot shows a web interface with a dark blue header containing navigation tabs: 'Home', 'Geräteliste', 'Karte', and 'Alle Messwerte'. Below the header, the main content area is titled 'GERÄT REGISTRIEREN'. A text block explains that the device must be registered once to store data in the Mcloud and that registration is only possible if the device has sent data at least once. Below this is a registration form with the following elements: a label 'Gerät registrieren', a text input field for 'Geräte-ID (Hex-Format):', another text input field for 'Messort (identisch mit Name):', a dropdown menu currently showing 'Xcom', and a 'Registrieren' button at the bottom right of the form.

Abb. 8.1: Registrierungsaufforderung der Mcloud von ORI.

Für jedes registrierte X-zone Com sehen Sie:



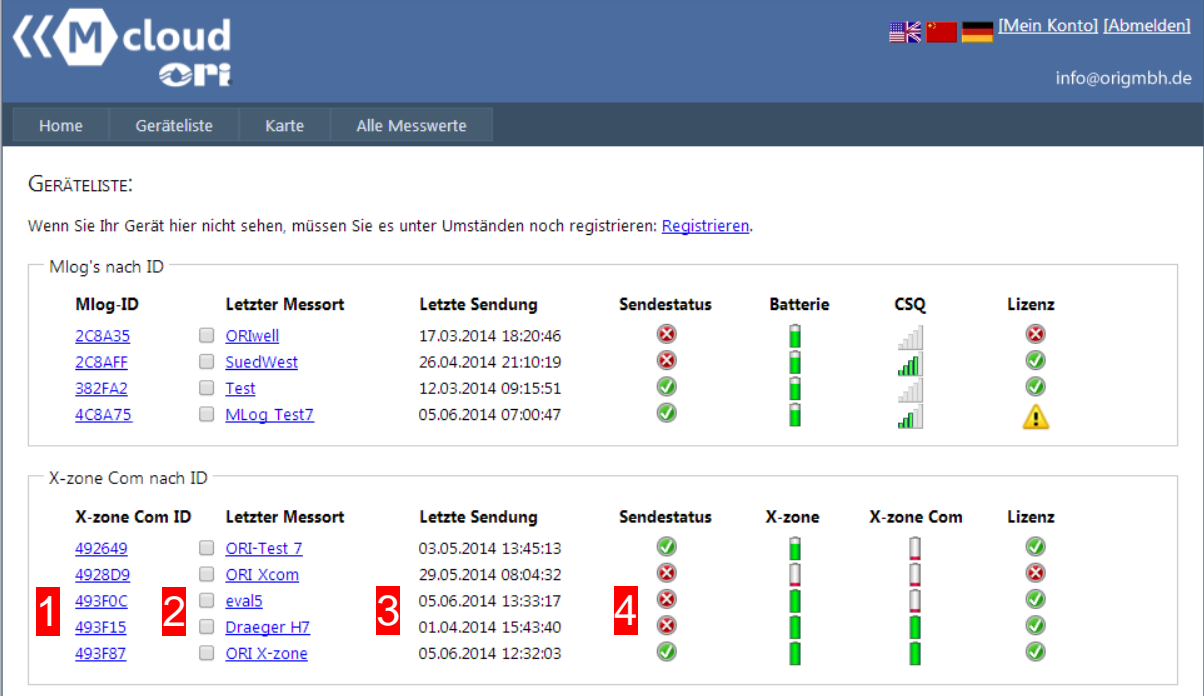













- **1** die Geräte-ID
- **2** letzten Messort (mit Hilfe der Manager Software vom Benutzer vergebener GeräteName)
- **3** wann das Gerät das letzte Mal gesendet hat
- **4** Sendestatus  = aktuell aktiv;  = über einen längeren Zeitraum inaktiv (ab 24 Std.)



GERÄTELISTE:

Wenn Sie Ihr Gerät hier nicht sehen, müssen Sie es unter Umständen noch registrieren: [Registrieren](#).

Mlog's nach ID

Mlog-ID	Letzter Messort	Letzte Sendung	Sendestatus	Batterie	CSQ	Lizenz
<a href="#">2C8A35</a>	<input type="checkbox"/> <a href="#">ORiwell</a>	17.03.2014 18:20:46				
<a href="#">2C8AFF</a>	<input type="checkbox"/> <a href="#">SuedWest</a>	26.04.2014 21:10:19				
<a href="#">3B2FA2</a>	<input type="checkbox"/> <a href="#">Test</a>	12.03.2014 09:15:51				
<a href="#">4C8A75</a>	<input type="checkbox"/> <a href="#">MLog_Test7</a>	05.06.2014 07:00:47				

X-zone Com nach ID



































X-zone Com ID	Letzter Messort	Letzte Sendung	Sendestatus	X-zone	X-zone Com	Lizenz
<a href="#">492649</a>	<input type="checkbox"/> <a href="#">ORI-Test 7</a>	03.05.2014 13:45:13				
<a href="#">4928D9</a>	<input type="checkbox"/> <a href="#">ORI Xcom</a>	29.05.2014 08:04:32				
<b>1</b> <a href="#">493F0C</a>	<input type="checkbox"/> <b>2</b> <a href="#">eval5</a>	<b>3</b> 05.06.2014 13:33:17	<b>4</b> 			
<a href="#">493F15</a>	<input type="checkbox"/> <a href="#">Draeger H7</a>	01.04.2014 15:43:40				
<a href="#">493F87</a>	<input type="checkbox"/> <a href="#">ORI X-zone</a>	05.06.2014 12:32:03				

Abb. 8.2: Liste aller registrierten Geräte, sowie der Link zur Geräteregistrierung.

In den weiteren Spalten werden gerätespezifische Zusatzinformationen mit Hilfe von Symbolen dargestellt. Bei einem X-zone Com z.B. die eigene Akkukapazität und die Akkukapazität des direkt verbundenen X-zone 5x00.

Akkukapazität (%)	CSQ (%) Signalstärke	Lizenzstatus
 ca. 75-100%	 ca. 100%	 Gültige Lizenz
 ca. 50-75%	 ca. 80%	 Lizenz läuft demnächst aus
 ca. 30-50%	 ca. 60%	 Lizenz ist abgelaufen
 ca. 15-30%	 ca. 40%	
 < 15%	 ca. 20%	
	 kein Signal	



## 8.2 M-CLOUD GERÄTESTATUS

Durch einen Klick auf die Geräte-ID (1) erhalten Sie detailliertere Informationen zum Gerät angezeigt. Hier lässt sich zur Sicherheit, die Überwachung des Sendeintervalls des Gerätes aktivieren. Hierfür geben Sie bei "Überwachungszeit Sendeintervall" den in der Manager Software vergebenen Sendezyklus ein (in Minuten). Nun wird geprüft ob in diesen Abständen von dem Gerät in die Cloud gesendet wird. Geschieht dies nicht wird ein Sendeintervallalarm ausgelöst.

Abb. 8.3: Zeigt den Gerätestatus nach Anklicken der Geräte-ID. Zur Zeit der Übertragung herrschte in Deutschland die Sommerzeit, daher wird als lokale Zeitzone 02:00:00 (UTC+2 - siehe Kap. 7.1.5) angezeigt.

Bei einem Sendeintervallalarm werden Sie durch ein E-Mail alarmiert und die Farbe des Gerätesymbols wechselt auf rot. Wird der Alarm quittiert wechselt auf der Karte das Gerätesymbol von rot auf grün. In die Kartenansicht wechseln Sie durch Klick auf den Menüpunkt [Karte] in der Hauptmenüleiste.



Abb. 8.4: Wechseln der Gerätesymbolfarbe auf der Karte von rot nach grün, nach der Quittierung eines anliegenden Sendeintervallalarms.

## 8.3 MLCLOUD MESSWERTE

Durch einen Klick auf den letzten Messort (2) gelangen Sie zur den aktuellen Messdaten des Gerätes. Hier lassen sich die vorhandenen, einzelnen Messsensoren markieren und anschließend ihre Messwerte grafisch für einen ausgewählten Zeitraum darstellen oder als CSV-Datei exportieren.

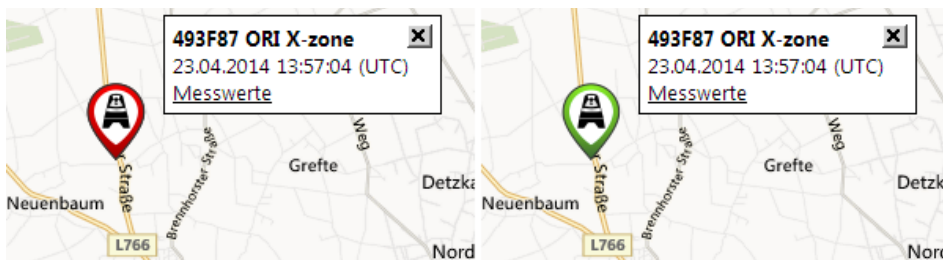

Abb. 8.5: Gezoomte grafische Darstellung der Messwerte zweier Gassensoren des X-zone Com Test\_7.

Die Datenreihen mehrerer Geräte können Sie anzeigen lassen, indem Sie die entsprechenden Checkboxen der Messorte markieren und dann anklicken. Alternativ klicken Sie in der Menüleiste auf [Alle Messwerte] um alle Geräte mit zugehörigen Sensoren zur Auswahl anzuzeigen.

### HINWEIS

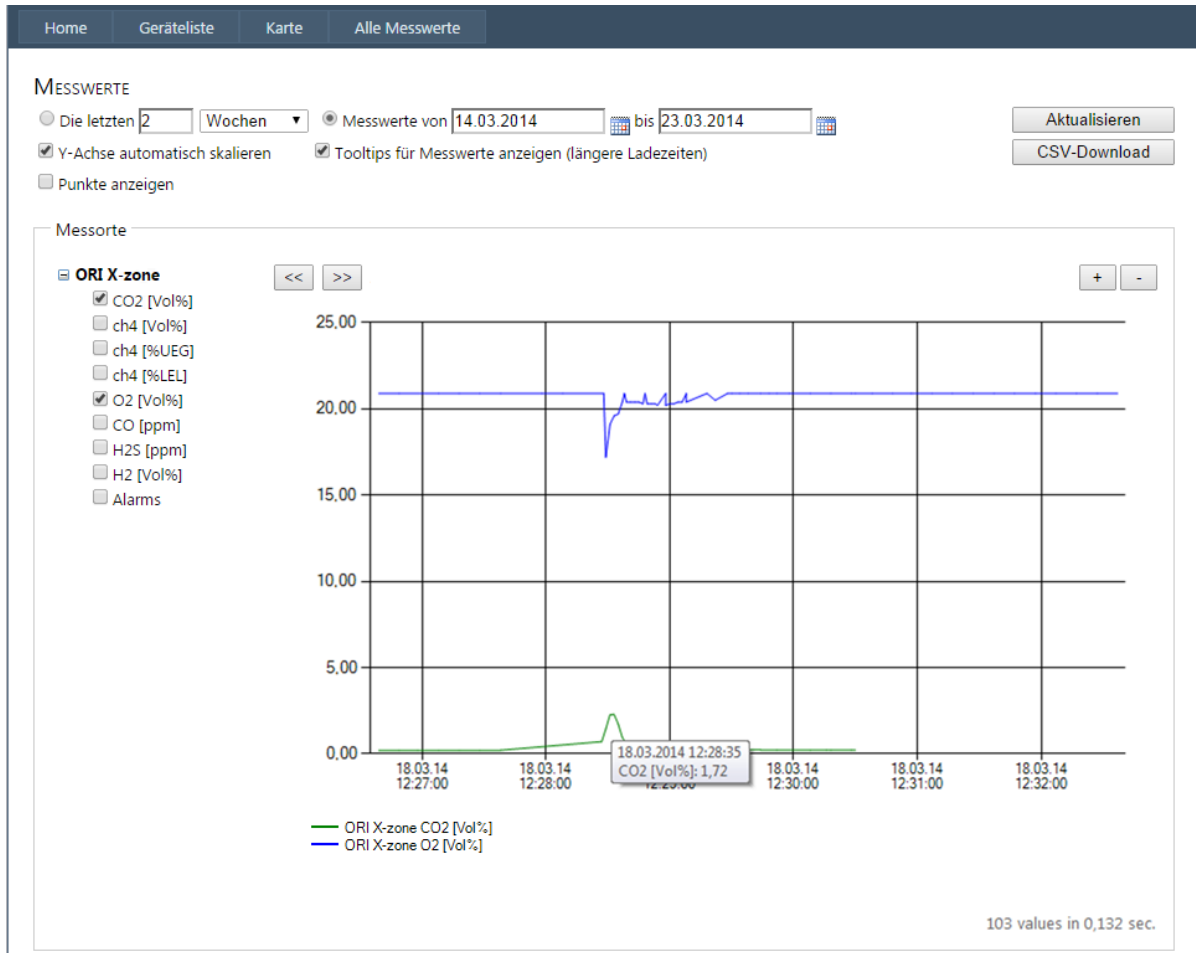

Es lassen sich mehrere Datenreihen von Geräten mit unterschiedlicher ID gleichzeitig grafisch darstellen oder exportieren. Ferner lassen sich auch unterschiedliche Messorte eines Gerätes mit unterschiedlichen Sensoren anzeigen.

## 8.4 M-CLOUD KARTENDARSTELLUNG

Durch einen Klick auf [Karte] in der Hauptmenüleiste wird die Position aller registrierten Geräte auf einer Karte angezeigt (Anzeige wählbar zwischen Kartenansicht, Vogelperspektive oder automatisch).





Angezeigte Gerätesymbole	
	X-zone Com
	Kamera
	Mlog
	Probenehmer



Abb. 8.6: Alle registrierten Geräte werden auf einer Karte angezeigt.

Durch Überfahren eines Gerätesymbols mit dem Mauszeiger erscheint rechts vom Symbol ein kleines Fenster mit der Geräte-ID, dem Gerätenamen, der Zeit der letzten Datenübermittlung und einem Link zu den Messwerten.

Mit dem Mauseisrad oder über die Lupensymbole links oben können Sie in die Karte hinein- oder herauszoomen.



Abb. 8.7: Position registrierter Geräte in der Kartendarstellung. Beim weiteren hineinzoomen wird automatisch in die Vogelperspektive gewechselt. Von den dort erkennbaren 2 Geräten hat eines seit längerem nicht mehr Daten in die Mcloud gesendet (rotes Gerätesymbol).

## 9 WARTUNG UND INSTANTHALTUNG

### 9.1 INTERVALLE

**X-zone Com:** Das Gerät muss regelmäßigen Inspektionen und Wartungen durch Fachleute unterzogen werden.

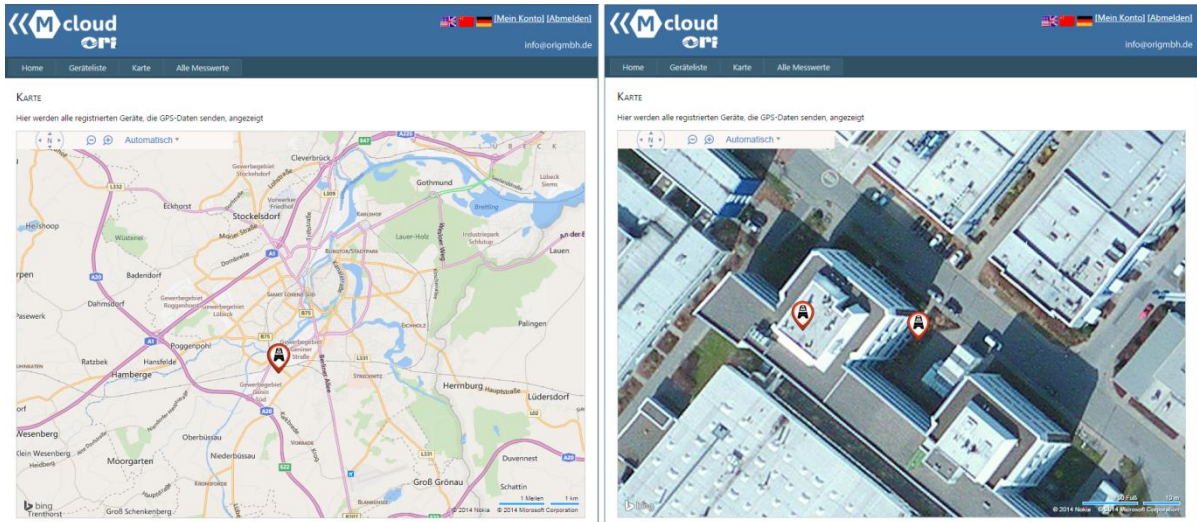
**Ladegerät:** Das Ladegerät benötigt keine spezielle Wartung. Ein evtl. notwendiger Service erfolgt durch den Hersteller oder von ihm autorisierte Personen.

### 9.2 REINIGEN

Gerät ausschließlich mit einem feuchten Tuch reinigen.

#### HINWEIS



**Zum Reinigen keine alkoholhaltigen Reiniger verwenden**

### 9.3 WECHSELN DES AKKUS IM REPARATURFALL

#### WARNUNG



**Explosionsgefahr!** Akkufach nicht innerhalb einer Ex-Atmosphäre öffnen. Der Akku ist Teil der Ex-Zulassung und das Trennen und Verbinden der Versorgungsspannung darf ausschließlich in einer nicht explosionsgefährdeten Umgebung vorgenommen werden.

#### VORSICHT



**Gerätebeschädigung!** Beim Öffnen des Gehäuses halten Sie das Oberteil des X-zone Com fest, damit Oberteil und Batterie nicht zu Boden fallen und beschädigt werden.



Abb. 9.1: Öffnen des Akkufachs.

Die 6 Gehäuseschrauben auf der Unterseite lösen.

Oberteil abnehmen.

Akku-Verbindungsstecker abziehen, Halteklammern lösen, Akku entnehmen.

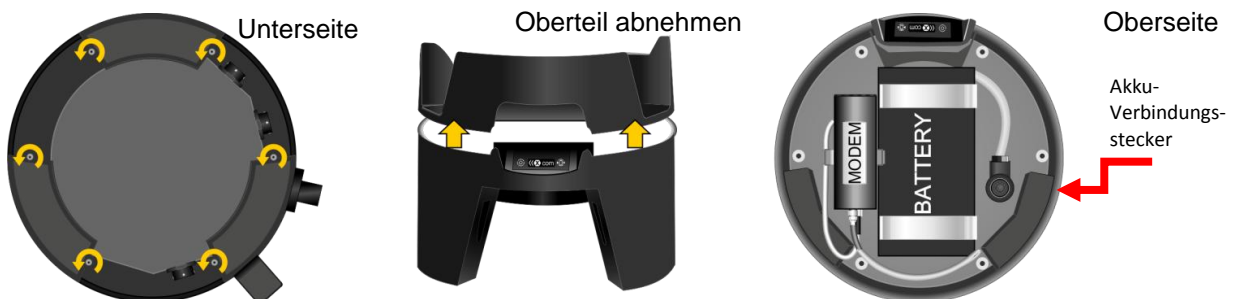
Der Zusammenbau des X-zone Com erfolgt in umgekehrter Reihenfolge. Ziehen Sie dabei die Schrauben handfest an.



# 10 ANHANG

## 10.1 FEHLERCODES

Fehlerkode	Displayanzeige (X-zone Com)	Beschreibung.	Abhilfe
<b>Gerätefehler</b>			
1	Check sum error	Speichertestfehler - Konfigurationspeicher	ORI Service kontaktieren.
2	Check sum error	Speichertestfehler - Datenspeicher	ORI Service kontaktieren.
3	Internal HW error	<i>Real time clock</i> läuft nicht	ORI Service kontaktieren.
6	Internal HW error	<i>RS485 bridge</i> funktioniert nicht	ORI Service kontaktieren.
<b>Akkufehler</b>			
9	Battery HW error	Kommunikationsfehler mit Akku-kontroller	ORI Service kontaktieren (Akku intern verbunden?)
10	Battery main alarm	Hauptalarm Akku	ORI Service kontaktieren.
11	Battery pre-alarm	Voralarm Akku	X-zone Com laden.
12	Battery empty	Akku komplett entladen	X-zone Com laden.
14	Battery too cold	Temperatur des Akku zu niedrig	Unterbrechen Sie das Aufladen und positionieren Sie das X-zone Com in eine wärmere Umgebung.
15	Charging error	Akkuladefehler	Akkuladefehler - ORI Service kontaktieren.
<b>GPS Fehler</b>			
16	GPS HW error	GPS Module funktioniert nicht	ORI Service kontaktieren.
17	GPS error	Unspezifizierter GPS-Fehler	ORI Service kontaktieren.
<b>GSM Fehler</b>			
20	GSM modem error	GSM Modem funktioniert nicht	Modem intern verbunden?
21	No SIM card	Keine SIM-Karte eingelegt	SIM-Karte einlegen.
22	SIM not working	SIM Karte funktioniert nicht	Neue SIM-Karte einlegen.
23	SIM: Wrong PIN	SIM-Karte: Falsche PIN	Konfigurieren Sie die richtige PIN mittels der Manager Software.
24	SIM blocked	SIM-Karte gesperrt: PUK Eingabe notwendig	Legen Sie die SIM-Karte in ein Mobiltelefon ein und entsperren Sie die Karte durch Eingabe des PUK ( <i>Personal Unblocking Key</i> ).
25	Roaming error	<i>Roaming</i> nicht erlaubt	Verwenden Sie eine entsprechende SIM-Karte.
26	GSM error	GSM - unbekannter Fehler	Konfigurieren und kontrollieren Sie die GSM/GPRS Einstellungen mittels der Manager Software (siehe Kap. 5.4.3).
27	No GSM network	Kein GSM-Netz gefunden	Ändern Sie die Geräteposition und kontrollieren Sie: <ul style="list-style-type: none"> <li>• die Signalstärke (siehe Kap. 5.4.3)</li> <li>• die Antenne</li> <li>• Gültigkeit der SIM-Karte und deren Guthaben</li> </ul>
28	Wrong APN login	GPRS Authentifizierungsfehler: falsche APN Angaben	Kontrollieren Sie mittels der Manager Software die folgenden Eingaben auf ihre Richtigkeit: <ul style="list-style-type: none"> <li>• APN ihres Mobilfunkbetreibers</li> <li>• Benutzername</li> <li>• Passwort</li> </ul>
29	GPRS error	GPRS - unbekannter Fehler	Konfigurieren und kontrollieren Sie die GSM/GPRS Einstellungen mittels der Manager Software (siehe Kap. 5.4.3).
30	IP error	Keine IP Adresse erhalten	Konfigurieren und kontrollieren Sie die GSM/GPRS Einstellungen mittels der Manager Software (siehe Kap. 5.4.3).
31	Unknown mail server	<i>Mail host name</i> kann nicht aufgelöst (zugeordnet) werden	Geben Sie einen gültigen E-Mail Servernamen an.
<b>SMS Fehler</b>			
40	Unknown phone no.	Unbekannte Telefonnummer	Konfiguration mittels der Manager Software.
41	SMS error	Unbekannter SMS-Fehler	Konfiguration mittels der Manager Software.
42	SMS not sent	SMS konnte nicht versendet wer-	Kontrollieren Sie:

		den	<ul style="list-style-type: none"> <li>• SMS-Einstellungen mittels der Manager Software.</li> <li>• bei Prepaid-Karten ihr Guthaben</li> </ul>
43	Wrong PIN in SMS	SMS mit falscher PIN erhalten	Setzen Sie mittels der Manager Software die "Lese-" und "Admin-PIN" und verwenden diese beim Versenden einer SMS an das X-zone Com (siehe Kap. 5.4.5)
47	Unknown email user	Unbekannter E-Mail Benutzer	Kontrollieren Sie mittels der Manager Software: <ul style="list-style-type: none"> <li>• den Benutzernamen</li> <li>• das Passwort</li> </ul>
48	Mailbox full	E-Mail-Fach voll	Kontrollieren Sie ihr E-Mail-Fach
49	Email rejected	E-Mail wurde abgelehnt	Kontrollieren Sie die E-Mail Einstellungen mittels der Manager Software
50	Email not sent	E-Mail konnte nicht versendet werden	Kontrollieren Sie mittels der Manager Software: <ul style="list-style-type: none"> <li>• die Signalstärke (siehe Kap. 5.4.3)</li> <li>• die E-Mail Einstellungen</li> </ul>
<b>Systemfehler</b>			
85	No time set	Keine Zeit- und Datumseinstellungen	Setzen Sie Datum und Uhrzeit mittels der Manager Software (siehe Kap. 5.4.1)
86	Incompatible SW	Modbus - Kommunikationsfehler mit X-zone 5x00	Aktualisieren Sie die Software des X-zone 5x00 und des X-zone Com.
89	X-zone missing	X-zone 5x00 wurde vom X-zone Com getrennt	Kontrollieren Sie: <ul style="list-style-type: none"> <li>• die Verbindung zum X-zone 5x00.</li> <li>• Modbus Einstellungen im X-zone 5x00 (115200, E, 8,1)</li> </ul>

## 10.2 BESTELLISTE

Beschreibung	ORI Bestell-Nr.	Dräger Bestell-Nr.
<b>X-zone Com Set</b> –  II 2C Ex ib [Ia IIC Ga] [Ib IIC] IIB T3/T4 Gb Kommunikationseinheit für Dräger X-zone 5x00	8094 100	8324383
<b>Ladegerät/Netzteil:</b>		
Ladegerät	8094 114	8324374
Netzleitung Europa	8094 142	8325391
Netzleitung Großbritannien	8094 141	8325392
Netzleitung Australien	8094 140	8325393
<b>Akku-pack</b>	8094 106	8324376
<b>Verbindungskabel:</b>		
RS232 für Verbindung X-zone Com / PC	8094 120	8324379
RS 485 für Verbindung X-zone Com / X-zone	8094 118	8324373
<b>Software</b>		
Manager Software für Parametrisierung des X-zone Com	5415 045-2	
Mcloud Lizenz 12 Monate	5415 061	8325346
Mcloud Lizenz 36 Monate	5415 063	8325347
<b>Ersatzteile:</b>		
Fixiergurtset (für sichere mechanische Verbindung zw. X-zone und X-zone Com mittels Gurtband)	8094 117	
Gurt-Set für Fixierung	8094 136	8324377
Fuß für X-zone Com mit Befestigungshalter	8094 135	8324384
<b>Ersatzteile:</b>		
GSM-GPRS Modem	5415 029	8324375
Batterie/Akku	8094 106	8324376
GSM Antenne X-zone Com	8094 108	8324372

## 10.3 FIRMWARE UPDATE

Für ein Firmware-Update des X-zone Com, benötigen Sie eine bestehende Verbindung zw. PC und X-zone Com via Bluetooth oder RS232-Verbindungsleitung. Ferner die Software "FirmLoader.exe" und eine aktuelle Firmwaredatei "XCOM VX\_XXX.fmw". Diese Erhalten Sie bei Ihrem zuständigen ORI- oder Dräger-Service. Bevor Sie fortfahren ermitteln Sie die COM-Port Nummer ihrer Verbindung falls diese nicht bekannt ist (siehe Kap. 5.1). Anschließend gehen Sie wie folgt vor:

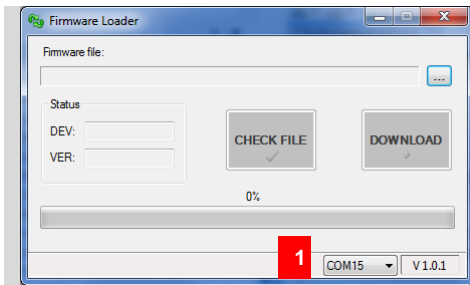

- 1 Starten Sie die "FirmLoader.exe" und wählen Sie den COM-Port aus.

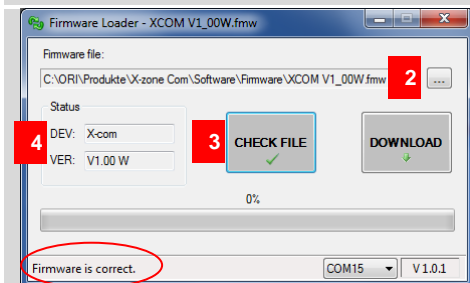

- 2 Wählen Sie die aktuelle Firmware-Datei aus.
- 3 Klicken Sie die Taste [CHECK FILE] um die ausgewählte Firmware zu prüfen.
- 4 In den Feldern "DEV" und "VER" werden Ihnen der Gerätetyp und die Versionsnummer der ausgewählten Firmware angezeigt.  
In der Statusleiste unten links erscheint ein Informationstext.

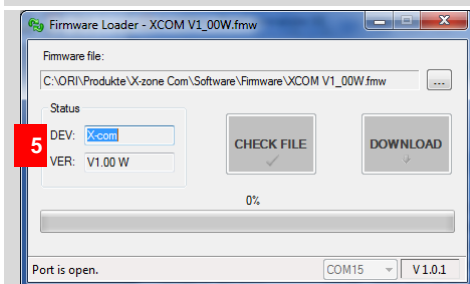

- 5 Kontrollieren Sie ob es sich um eine Firmware für ein X-zone Com handelt.

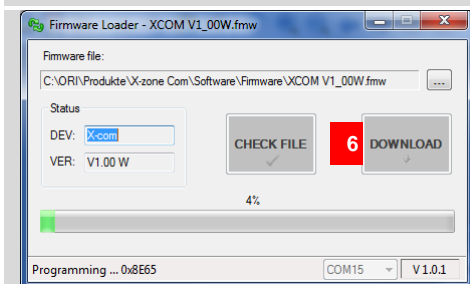

- 6 Klicken Sie nun [DOWNLOAD] um die Firmware auf Ihr X-zone Com einzuspielen

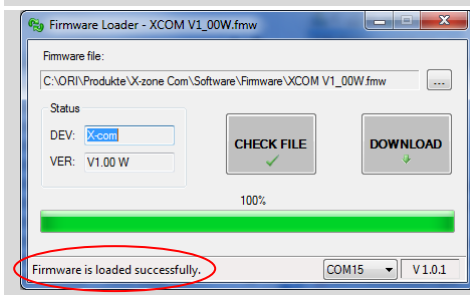

Wurde die Firmware erfolgreich aufgespielt wird dies in der Statusleiste unten links angezeigt.

Beenden Sie den "Firmware Loader" durch einen Klick auf  des Fenstermenüs.



### HINWEIS



*Bei einer bestehenden Verbindung mit einem X-zone 5X00 erfolgt während des DOWNLOADS ein Gerätealarm.*

War ein Update nicht erfolgreich, prüfen Sie bitte alle Verbindungen. Vergewissern Sie sich, dass bei einer Bluetooth-Verbindung der Computer Ihr X-zone Com erkennt und die Entfernung zwischen beiden Geräten nicht zu groß ist oder durch dazwischenstehende Hindernisse gestört wird. Prüfen Sie die COM-Port-Nummer.

Starten Sie anschließend das Update erneut.

## 10.4 ZERTIFIKATE

	<h1>IECEX Certificate of Conformity</h1>	
<b>INTERNATIONAL ELECTROTECHNICAL COMMISSION</b> <b>IEC Certification Scheme for Explosive Atmospheres</b> for rules and details of the IECEx Scheme visit <a href="http://www.iecex.com">www.iecex.com</a>		
Certificate No.:	<input type="text" value="IECEX FTZU 14.0013X"/>	issue No.: <input type="text" value="0"/>
Status:	<input type="text" value="Current"/>	
Date of Issue:	<input type="text" value="2014-06-13"/>	Page 1 of 3
Applicant:	<b>ORI-Abwassertechnik GmbH &amp; Co. KG</b> Bollacken 2, 32479 Hille Germany	
Electrical Apparatus: <i>Optional accessory:</i>	Communication Equipment Device COM	
Type of Protection:	Intrinsic safety	
Marking:	Ex ib [ia IIC Ga] [ib IIC] IIB T3/T4 Gb	
<i>Approved for issue on behalf of the IECEx Certification Body:</i>	Dipl. Ing. Lukáš Martinák	
<i>Position:</i>	Head of the Certification Body	
<ol style="list-style-type: none"><li>1. This certificate and schedule may only be reproduced in full.</li><li>2. This certificate is not transferable and remains the property of the issuing body.</li><li>3. The Status and authenticity of this certificate may be verified by visiting the Official IECEx Website.</li></ol>		
Certificate issued by:		
		



Physical Technical Testing Institute  
Ostrava – Radvanice



## EC-Type Examination Certificate

(1)  
(2)

Equipment or Protective Systems Intended for Use  
in Potentially Explosive Atmospheres  
(Directive 94/9/EC)

(3) EC-Type Examination Certificate Number:

**FTZÚ 14 ATEX 0048X**

- (4) Equipment or protective system: **Communication Equipment Device.COM**
- (5) Manufacturer: **ORI Abwassertechnik GmbH & Co. KG**
- (6) Address: **Bollacken 2, D-32479 Hille, Germany**
- (7) This equipment or protective system and any of acceptable variation thereto is specified in the schedule to this certificate and the documents therein referred to.
- (8) The Physical Technical Testing Institute, notified body number 1026 in accordance with Article 9 of the Council Directive 94/9/EC of 23 March 1994, certifies that this equipment or protective system has been found to comply with the Essential Health and Safety Requirements relating to the design and construction of equipment and protective systems intended for use in potentially explosive atmospheres given in Annex II to the Directive.
- The examination and test results are recorded in confidential Report N°:  
**14/0048 dated 13.06.2014**
- (9) Compliance with Essential Health and Safety Requirements has been assured by compliance with:  
**EN 60079-0:2012, EN 60079-11:2012, EN 60079-26:2007**
- (10) If the sign "X" is placed after the certificate number, it indicates that the equipment or protective system is subject to special conditions for safe use specified in the schedule to this certificate.
- (11) This EC-Type Examination Certificate relates only to the design, examination and testing of the specified equipment or protective system in accordance to the directive 94/9/EC. Further requirements of the Directive apply to the manufacturing process and supply of this equipment or protective system. These are not covered by this certificate.
- (12) The marking of the equipment or protective system shall include following:



**II 2G Ex ib [ia IIC Ga] [ib IIC] IIB T3/T4 Gb**

This EC-Type Examination Certificate is valid till: **13.06.2019**

Responsible person:

  
Dipl. Ing. Lukáš Martinák  
Head of Certification Body



Date of issue: 13.06.2014

Page: 1/4

This certificate is granted subject to the general conditions of the FTZÚ, s.p.  
This certificate may only be reproduced in its entirety and without any change, schedule included.

FTZÚ, s.p., Pikartská 1337/7, 716 07 Ostrava-Radvanice, Czech Republic,  
tel +420 595 223 111, fax +420 596 232 672, ftzu@ftzu.cz, www.ftzu.cz



Physical Technical Testing Institute  
Ostrava – Radvanice



## Supplement No. 1 to EC-Type Examination Certificate

- (1)
- (2) **Equipment or Protective Systems Intended for Use  
in Potentially Explosive Atmospheres  
(Directive 94/9/EC)**

(3) EC-Type Examination Certificate Number:

**FTZÚ 14 ATEX 0048X**

(4) Equipment or protective system: **Communication Equipment Device.COM**

(5) Manufacturer: **ORI Abwassertechnik GmbH & Co. KG**

(6) Address: **Bollacken 2, D-32479 Hille, Germany**

- (7) This supplement of certificate is valid for:
- modification of certified apparatus
  - modification of apparatus marking
  - new model (variant) external power supply **02617PS**
- (8) Modification of certified apparatus (protective system) and any of its approved variants are specified in documentation, list of which is mentioned in schedule of this certificate.
- (9) This supplement to type examination certificate is valid only for type examination of design and construction of product sample in accordance with Annex 3 Paragraph 6) of Directive No. 94/9/EC. The Directive contains another requirements, which manufacturer shall fulfil before products are placed on market or introduced in service.
- (10) Safety requirements of modified parts were fulfilled by satisfying the following standards:  
**EN 60079-0:2012, EN 60079-11:2012, EN 60079-26:2007**
- (11) Marking of equipment shall contain symbols:

 **II 2G Ex ib [ia IIC Ga] [ib IIC] IIB T3/T4 Gb**

 **II (2)G [Ex ib Gb] IIB** zdroj 02617PS

(12) This type examination certificate is valid till: **13.06.2019**

Responsible person:

  
Dipl. Ing. Lukáš Martinák  
Head of Certification Body



Date of issue: 20.10.2014

Page: 1/3

This supplement to certificate is granted subject to the general conditions of the FTZÚ, s.p.  
This supplement to certificate may only be reproduced in its entirety and without any change, schedule included.

FTZÚ, s.p., Pikartská 1337/7, 716 07 Ostrava-Radvanice, Czech Republic,  
tel +420 595 223 111, fax +420 596 232 672, ftzu@ftzu.cz, www.ftzu.cz

# X-zone COM

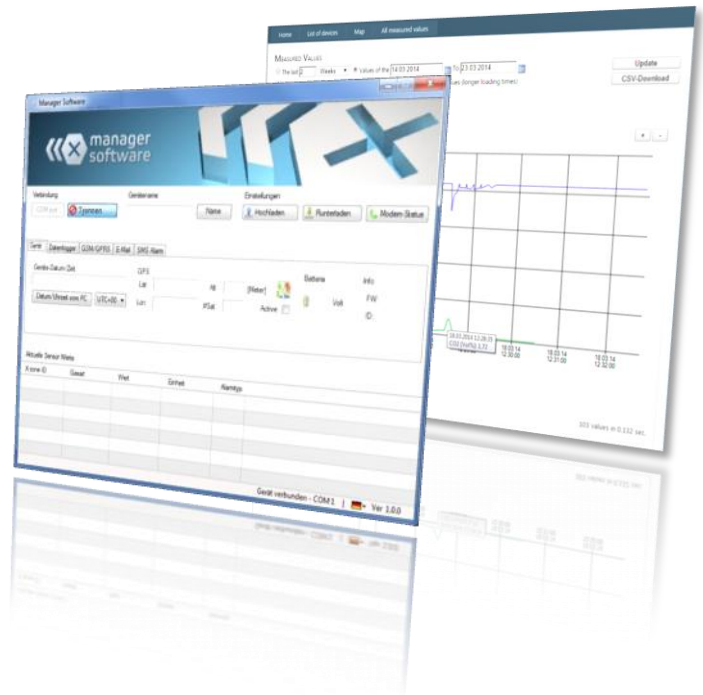

X-zone Com  II 2G Ex ib [ia IIC Ga] [ib IIC] IIB T3/T4 Gb  
Type: 02617

## Mode d'emploi

Rev20141022-01

Réf. 8094130



---

## Traduction

Si des inexactitudes apparaissent dans le texte traduit, il faut prendre le mode d'emploi dans sa version originale (allemand) comme référence pour les clarifier, ou contacter le fabricant.

## Copyright

Sauf autorisation formelle, la reproduction de ce document, le réemploi ou la diffusion de son contenu sont interdits. Toute infraction entraîne des dommages-intérêts. Tous droits réservés.

## Noms d'usage

L'utilisation de noms d'usage, de noms commerciaux, de désignations de marchandises ou similaires dans ce mode d'emploi ne permet pas de supposer que lesdits noms puissent être utilisés librement par quiconque; il s'agit souvent de marques déposées protégées par la loi, même si elles ne sont pas identifiées comme telles.

## Avis technique :

Ce document ne remplace pas la documentation technique des certificats valides. Si besoin, demandez cette documentation séparément auprès de ORI GmbH & Co.KG.

## Utilisation en milieu explosif

Les appareils et composants utilisés dans les zones à risque en matière d'explosion et contrôlés et homologués selon les directives nationales, européennes ou internationales de protection contre les explosions, ne peuvent être utilisés que dans les conditions stipulées dans l'homologation et sous respect des dispositions légales qui s'y rattachent. **Aucune modification ne peut être apportée aux moyens de production, aux appareils ou composants. L'utilisation de pièces défectueuses ou incomplètes est interdite.** En cas de remise en état de cet appareil ou de ces composants, les dispositions correspondantes doivent être respectées.

L'appareil doit faire l'objet d'inspections et d'entretiens réguliers par des spécialistes.



**A lire attentivement avant  
la mise en service !**

---

(Inscrire ici le numéro de série X-zone Com)

## SOMMAIRE

<b>1</b>	<b>Généralités.....</b>	<b>5</b>
1.1	Descriptif fonctionnel .....	5
1.2	Utilisation conforme .....	5
1.3	Stockage et retour .....	6
1.4	Mise au rebut .....	6
<b>2</b>	<b>Consignes de Sécurité.....</b>	<b>7</b>
2.1	Sigles de sécurité et symboles .....	7
2.2	Consignes de sécurité .....	8
2.3	Sécurité de fonctionnement.....	8
<b>3</b>	<b>Structure et Données Techniques .....</b>	<b>9</b>
3.1	Dimensions .....	9
3.1.1	X-zone Com + X-zone 5x00 .....	9
3.1.2	Chargeur I.S. Power supply 02617PS.....	10
3.2	Interfaces X-zone Com et chargeur.....	10
3.2.1	X-zone Com .....	10
3.2.2	Chargeur I.S. Power supply 02617PS.....	12
3.3	Identification.....	13
3.4	Spécifications de l'appareil .....	14
3.4.1	X-zone Com .....	14
3.4.2	Chargeur .....	15
<b>4</b>	<b>Montage et mise en service .....</b>	<b>16</b>
4.1	Installation du logiciel de gestion .....	16
4.1.1	Pré-requis système .....	16
4.1.2	Installation du Manager Software .....	16
4.2	Première mise en service .....	18
4.2.1	Chargement de la batterie .....	18
4.2.2	Insertion de la carte SIM.....	19
4.2.3	Montage et démontage de l'antenne .....	21
4.2.4	Raccordement avec le X-zone 5x00.....	22
4.3	Deconnexion du X-zone 5x00 .....	24
<b>5</b>	<b>Configuration du X-zone Com .....</b>	<b>25</b>
5.1	Réalisation d'une connexion avec un PC .....	25
5.1.1	Connexion Bluetooth .....	25
5.1.2	Connexion filaire .....	26
5.2	Vue d'ensemble/vue de démarrage.....	27
5.3	Informations de connexion.....	28
5.3.1	Établissement d'une connexion vers le X-zone Com.....	28
5.3.2	Désignation de l'appareil / Modifier le nom du lieu de mesure.....	29
5.3.3	Enregistrement et chargement des paramètres X-zone Com .....	30
5.3.4	Afficher l'historique des données .....	30
5.4	Configuration du X-zone Com .....	32

5.4.1	Formulaire "Appareil".....	33
5.4.2	Formulaire "Data Logger" (enregistreur de données).....	34
5.4.3	Formulaire "GSM/GPRS".....	35
5.4.4	Formulaire "Email".....	36
5.4.5	Formulaire "SMS".....	38
5.4.6	Formulaire "State".....	39
5.5	Plage de valeurs mesurées.....	40
<b>6</b>	<b>Commande sur le X-zone Com.....</b>	<b>41</b>
6.1	Panneau de commande.....	41
6.2	Mise en route de l'appareil.....	41
6.3	Eteindre l'appareil.....	42
6.4	Affichages écran.....	42
6.4.1	Tableau des symboles.....	42
6.4.2	Affichages erreurs.....	43
6.5	Réaliser un test de fonctionnement.....	44
<b>7</b>	<b>SMS au X-zone Com.....</b>	<b>45</b>
7.1	Ordres SMS de lecture.....	46
7.1.1	Consultation du statut.....	46
7.1.2	Consultation des informations concernant le statut du groupe.....	47
7.1.3	Valeurs mesurées du X-zone 5x00 raccordé localement.....	48
7.1.4	Consultations des valeurs mesurées maximales dans un groupe.....	49
7.1.5	Afficher les coordonnées GPS.....	50
7.1.6	Consultation des alarmes en cours.....	51
7.2	Commandes SMS d'exécution.....	53
7.2.1	Acquittement alarme.....	53
7.2.2	Activer l'alarme d'évacuation.....	53
7.2.3	Mettre fin à l'alarme d'évacuation.....	54
<b>8</b>	<b>Bref Aperçu du Mcloud.....</b>	<b>55</b>
8.1	Liste des appareils Mcloud.....	55
8.2	Statut appareil Mcloud.....	57
8.3	Valeurs mesurées Mcloud.....	58
8.4	Représentation cartographique.....	59
<b>9</b>	<b>Entretien et Maintenance.....</b>	<b>61</b>
9.1	Intervalle.....	61
9.2	Nettoyage.....	61
9.3	Changement de la batterie en cas de réparation.....	61
<b>10</b>	<b>Annexe.....</b>	<b>62</b>
10.1	Codes d'erreurs.....	62
10.2	Liste de commande.....	63
10.3	Mise à jour du microprogramme.....	64
10.4	Certificats.....	66



# 1 GÉNÉRALITÉS

## 1.1 DESCRIPTIF FONCTIONNEL

L'unité de localisation et de communication X-zone Com est prévue pour un usage dans les milieux industriels. Cela complète le système de détection de gaz Dräger X-zone 5x00 avec le Dräger X-am 5x00 (ci-après dénommé X-zone 5x00).

Raccordé à un X-zone 5x00, le X-zone Com relève régulièrement les concentrations en gaz et les valeurs d'alarme du X-zone 5x00 et les stocke jusqu'à ce qu'il puisse les envoyer au serveur ORI Mcloud ou à un destinataire e-mail défini par l'utilisateur. Si le X-zone 5x00 (sans fil ou filaire) est relié à un autre X-zone 5x00, les valeurs d'alarme du réseau sont transmises en plus. Dans le cas d'un réseau fermé X-zone (groupe), ce sont les concentrations maximales en gaz du groupe qui sont relevées, stockées et envoyées au lieu des valeurs mesurées du X-zone 5x00 raccordé.

Le X-zone Com ajoute des données de position à toutes les valeurs mesurées du X-zone 5x00, dans la mesure où il a pu calculer une position GPS.

Il est par ailleurs en mesure de recevoir des demandes de situations par SMS et d'y répondre par SMS et envoie aussi bien des e-mails que des SMS en cas d'alarmes.

Par le biais du Bluetooth ou d'une connexion série, l'utilisateur peut configurer le X-zone Com à l'aide d'un logiciel PC (ci-après dénommé Manager Software<sup>1</sup>).

## 1.2 UTILISATION CONFORME

Le X-zone Com peut être exploité dans les milieux explosifs des zones 1 et 2 (conformément à  II **2G Ex ib [Ia IIC Ga] [Ib IIC] IIB T3/T4 Gb**) associé à l'amplificateur d'alarme Dräger X-zone 5x00. Une utilisation ou une transformation de cet appareil en dehors de ce cadre, sans accord écrit du fabricant, sont considérés comme non conformes et entraînent la perte de l'homologation ATEX et de la garantie !

Le fabricant n'est pas responsable des dommages résultant d'un usage non conforme ou d'une mauvaise utilisation de l'appareil, l'exploitant supporte seul le risque. Lorsque l'appareil est mal utilisé, des risques peuvent en émaner. Si vous vous apercevez qu'une exploitation sans danger n'est plus possible, veuillez immédiatement mettre l'appareil hors service.

Une bonne connaissance et le respect du mode d'emploi font également partie d'une utilisation conforme.

<sup>1</sup> Logiciel de gestion

### REMARQUE



*Veillez lire attentivement les consignes d'utilisation séparées du Dräger X-zone 5x00 et des appareils de mesure raccordés Dräger X-am 5x00. Respectez notamment les consignes de sécurité respectives.*

## 1.3 STOCKAGE ET RETOUR

**Stockage** : Débranchez les éventuelles liaisons existantes avec le X-zone 5x00. Veuillez respecter les consignes du fabricant pour le X-zone 5x00. Stockez le X-zone Com éteint avec son chargeur hors de la zone ATEX et pas à l'air libre. Dans le cas d'un stockage sans chargeur, il faut effectuer un chargement complet de la batterie interne sur 48 heures dans les 6 mois au plus tard.

**Retour** : Les mesures suivantes sont à prendre avant de renvoyer l'appareil à ORI Abwassertechnik GmbH & Co. KG, par ex. en vue de réparations :

- Retirer toutes les saletés. Ceci est particulièrement important lorsque les saletés sont dangereuses pour la santé, par ex. combustibles, toxiques, caustiques, cancérigènes etc.

Les frais dus à un mauvais nettoyage de l'appareil, de mise au rebut éventuelle ode déchets spéciaux ou liés à des dommages à la personne (brûlures etc.), seront facturés à l'utilisateur.

## 1.4 MISE AU REBUT

**Emballage** : Conservez l'emballage de l'appareil pour le réutiliser pour un transport ultérieur. Sinon, les matériaux d'emballage en bois, carton ou PE peuvent être jetés par le biais des filières classiques.

**X-zone Com**: Ne peut être jeté comme un déchet ménager (conformément à la directive 2002/96/CE). Tenez compte de l'impact sur l'environnement, des risques sanitaires et des consignes locales en matière de mise au rebut. Nettoyez et désinfectez l'appareil et apportez-le à un point de collecte habilité. Vous trouverez de plus amples informations auprès des autorités compétentes. Pour un envoi en franco, nous prenons en charge, sur demande, la mise au rebut gratuite de votre ancien X-zone Com. Pour cela, veuillez vous référer au paragraphe Retour dans la section précédente.



**Batterie** : Le bloc batterie présent dans le X-zone Com ne peut être jeté comme un déchet ménager (conformément à la directive 2006/66/CE). Il doit être mis au rebut selon les prescriptions en vigueur auprès des points de collecte de piles locaux.

## 2 CONSIGNES DE SÉCURITÉ

### 2.1 SIGLES DE SÉCURITÉ ET SYMBOLES

Une exploitation correcte et fiable de l'appareil n'est garantie que si vous suivez à la lettre les consignes de sécurité de ce mode d'emploi. Les consignes de sécurité contenues dans ce mode d'emploi renvoient au niveau de risque escompté et sont indiquées par les symboles et couleurs suivants :

**AVERTISSEMENT**



*Les avertissements renvoient à des situations dangereuses potentielles pouvant entraîner des blessures graves ou la mort de personnes ou un risque en matière de sécurité. Respectez à la lettre les consignes de travail et prenez les précautions correspondantes.*

**PRUDENCE**





*« Prudence » renvoie aux situations potentiellement dangereuses, qui peuvent – si elles ne sont pas traitées comme il se doit – entraîner des blessures, un fonctionnement défectueux, des dommages sur l'appareil ou nuisances pour l'environnement. Veuillez respecter rigoureusement la procédure.*

**REMARQUE**



*Indications générales, informations ou astuces, mais aucune indication pour prévenir d'un danger.*

Autres symboles :

Symbole	Descriptif
	Porter des vêtements de protection
	Lire les modes d'emploi

---

## 2.2 CONSIGNES DE SÉCURITÉ

---

Les consignes suivantes doivent être respectées pour le X-zone Com.

### PRUDENCE



*L'appareil doit être régulièrement soumis à des inspections et entretiens par des spécialistes (voir IEC 60079-1).*

### AVERTISSEMENT



#### **Risque d'explosion !**

*Si le boîtier ou des pièces du boîtier sont abîmés, l'appareil doit être immédiatement mis hors service et protégé de toute nouvelle mise en route intempestive.*

### AVERTISSEMENT



#### **Risque d'explosion !**

*Procéder aux opérations de réparation, d'entretien et de maintenance exclusivement dans un environnement non exposé aux risques d'explosion.*

### AVERTISSEMENT



#### **Danger de mort !**

*Respecter impérativement les consignes de sécurité du Dräger X-zone 5x00 et du Dräger X-am 5x00 raccordés !*

---

## 2.3 SÉCURITÉ DE FONCTIONNEMENT

---

**Réparations** : Les réparations et autres interventions sur l'appareil, non décrites dans ce mode d'emploi, doivent être exclusivement réalisées par le fabricant lui-même ou par un SAV agréé par le fabricant.

**Progrès technique** : Le fabricant se réserve le droit d'adapter les données techniques au progrès technique, sans avis spécifique préalable. Des renseignements sur les activités et sur les ajouts éventuels à ce mode d'emploi sont disponibles auprès de ORI Abwassertechnik GmbH & Co. KG.

## 3 STRUCTURE ET DONNÉES TECHNIQUES

Les données figurant dans le mode d'emploi s'appliquent exclusivement au type d'appareil indiqué sur la page de garde.

Le X-zone Com possède une batterie intégrée, avec laquelle il est utilisé au sein des zones ATEX (conformément à la directive 94/9/CE). Les panneaux de commande sont gérés à l'aide du stylet magnétique livré avec l'appareil. Un modem GSM/GPRS destiné à transmettre les alarmes, les statuts et les données est intégré. Les valeurs transmises par le X-zone 5x00 sont placées dans une mémoire interne. Il est possible de stocker environ 262.000 champs de données. La mémoire est conçue en tant que mémoire circulaire de sorte que les données les plus anciennes sont écrasées en cas de dépassement des 262.000 champs de données.

### 3.1 DIMENSIONS

#### 3.1.1 X-zone Com + X-zone 5x00

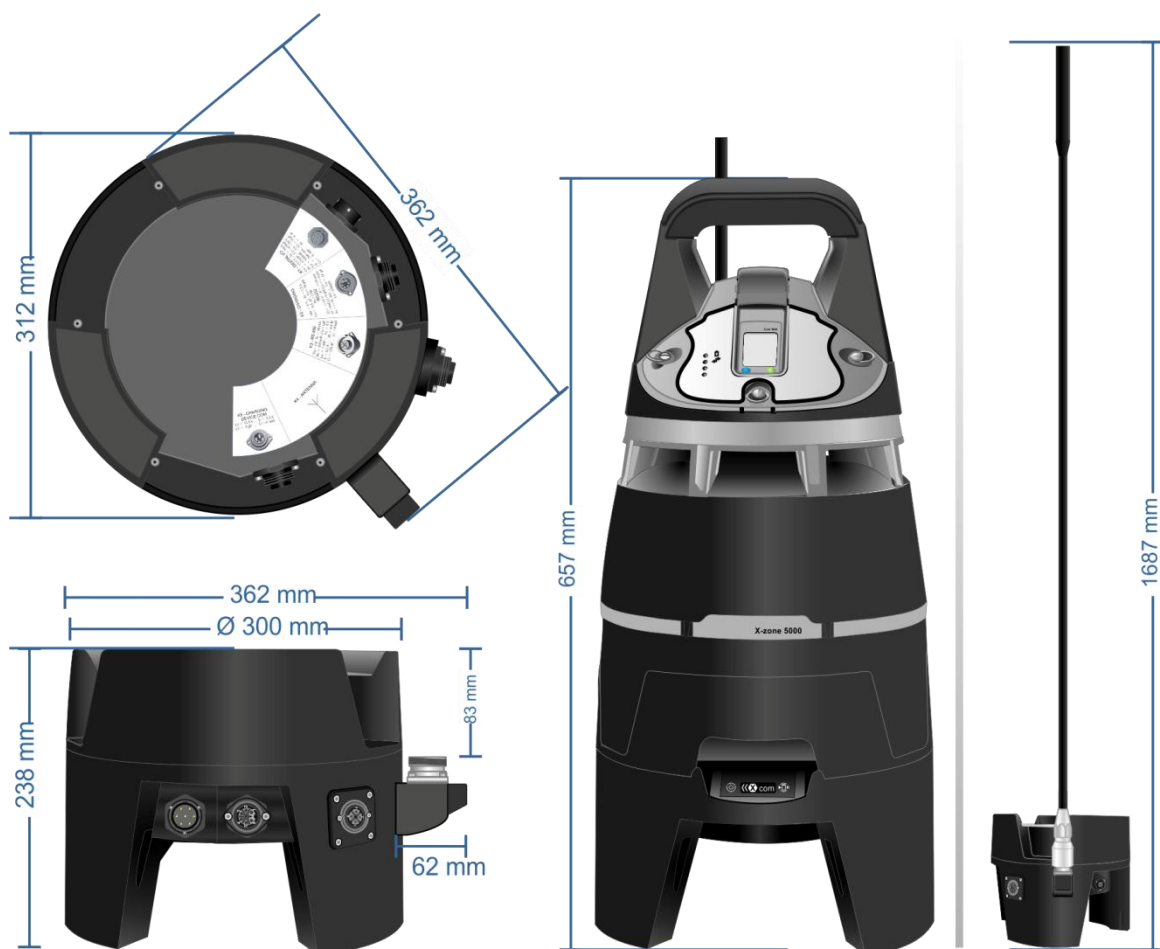

Fig. 3.1: Dimensions X-zone Com et X-zone Com mit X-zone 5x00.

### 3.1.2 Chargeur I.S. Power supply 02617PS

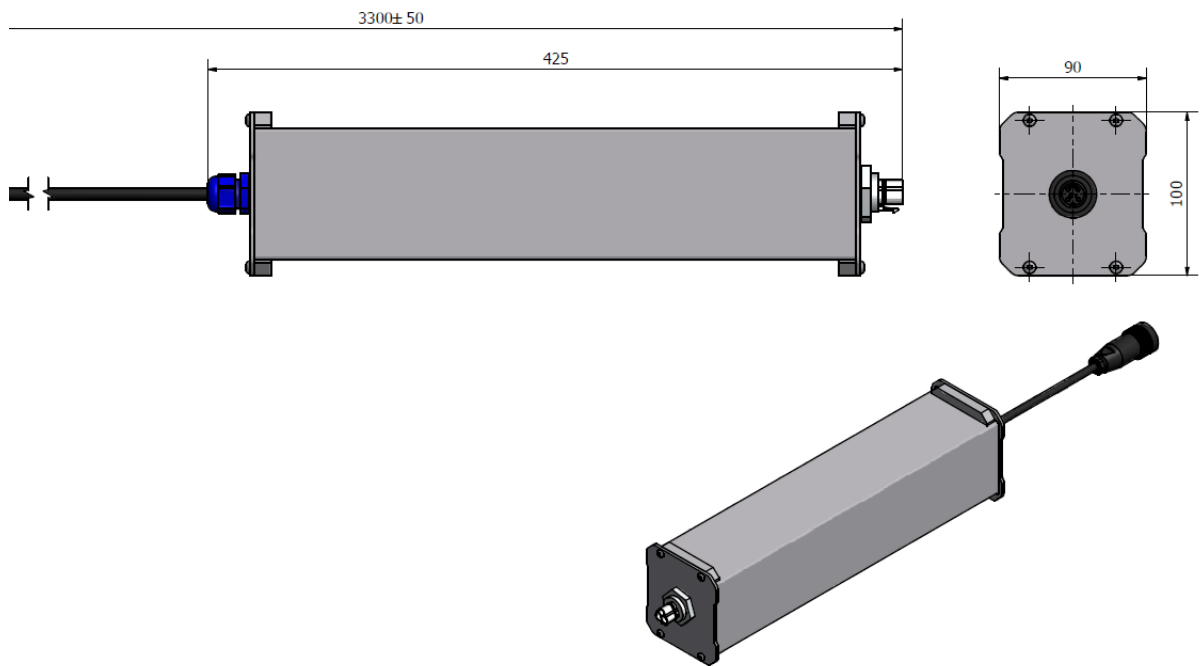

Fig. 3.2: Dimensions chargeur en mm

## 3.2 INTERFACES X-ZONE COM ET CHARGEUR

### 3.2.1 X-zone Com

Le X-zone Com comporte différentes interfaces pour la transmission des données (K3=RS485, K2=RS232), une entrée/sortie numérique (K1), le branchement d'un chargeur (K5) ainsi qu'un socle pour l'antenne GSM/GPRS (K4).

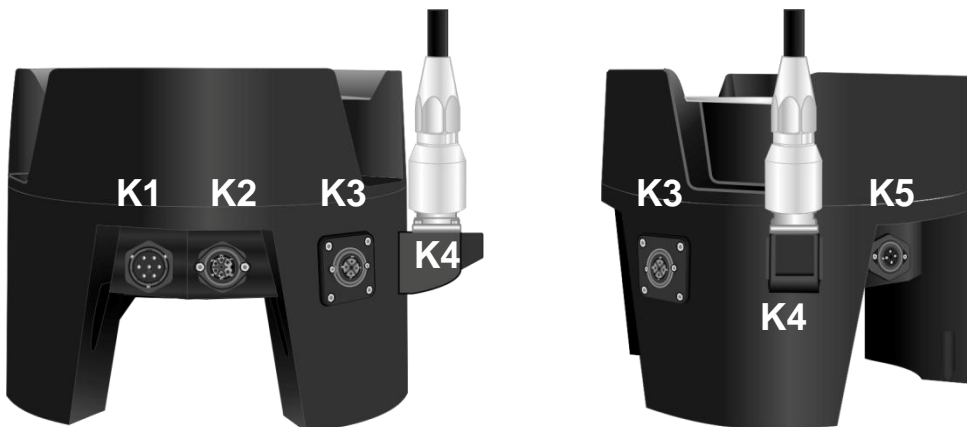







Fig. 3.3: Emplacement interfaces du X-zone Com.

	Fonction	Modèle	Vue	Affectation
<b>K1</b>	I / O numérique	Connecteur 7 pôles		3. GND 4. Normally closed (NC) 5. Normally open (NO) 6. Common (COM) 7. Input
<b>K2</b>	RS232 Interface série (DTE)	Prise 7 pôles		1. TxD 2. CTS 3. RTS 4. Charging + 5. Charging GND 6. GND (RS232) 7. RxD
<b>K3</b>	RS485 Connexion X-zone 5x00	Prise 3 pôles+PE		1. PLUS (+) 2. MINUS (-) 3. GND
<b>K4</b>	Prise antenne	Prise HF 7/16 DIN		
<b>K5</b>	Branchement chargeur X-zone Com	Connecteur 3-pôles + PE		1. Charging + 2. Charging GND
	Batterie interne	Prise 7 pôles		1. Communication (SCL) 2. Communication (SDA) 3. RESET 4. appliance output (+) 5. appliance GND 6. Input external source (+) 7. Input external source (GND)

## 3.2.2 Chargeur I.S. Power supply 02617PS

Le câble d'alimentation du chargeur existe dans trois modèles différents :

Avec connecteur	Pays / Région	N° de commande ORI	N° de commande Dräger
CEE 7/7	Europe	Compris dans la livraison	8325 391
AS3112	Australie	8094 140	8325 393
BS 1363	Grande-Bretagne	8094 141	8325 392

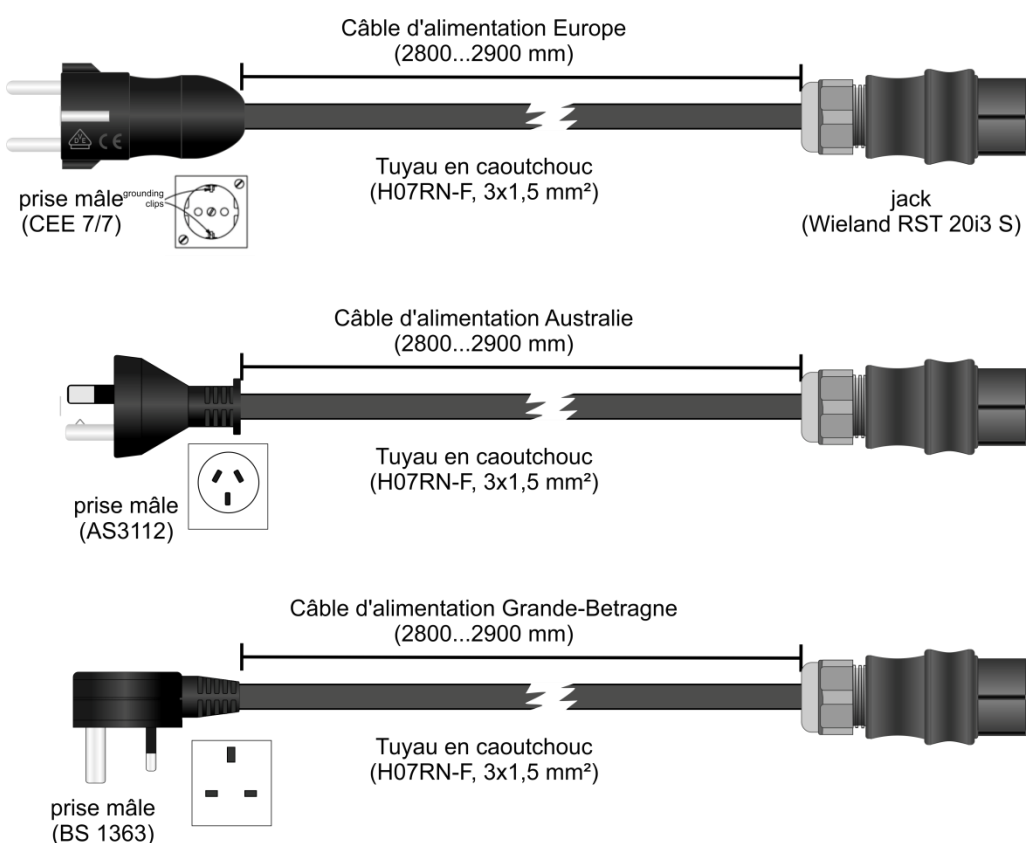
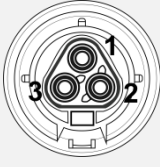



Fig. 3.4: Conduite du chargeur (pour l'Europe, l'Australie, la Grande-Bretagne).

Fonction	Modèle	Vue	Affectation
<b>Connecteur</b>	CEE 7/7		
<b>Connecteur d'entrée</b>	Wieland RST20i3S 3 pôles		1. L1 (noir) 2. N (bleu) 3. PE (vert/jaune)
<b>Prise sortie</b>	Binder RD24 Serie 693 - 3 pôles+PE		1. PLUS (+) 2. GND 3. Normally closed (NC) 4. Normally closed (NC)



### 3.3 IDENTIFICATION

La plaque signalétique est apposée sur la partie supérieure du X-zone Com et comprend les indications suivantes :

- Désignation de l'appareil
- Nom et adresse du fabricant
- Identification CE
- Identification de la série et numéros de type.
- Numéro de série, l'année de construction est contenue dans le numéro de série
- Bureau de certification, année d'homologation, numéro d'homologation et type de protection du boîtier
- Identification ATEX

Pour toute question et commande de pièces détachées, il est important d'indiquer la désignation de l'appareil ainsi que le numéro de série.

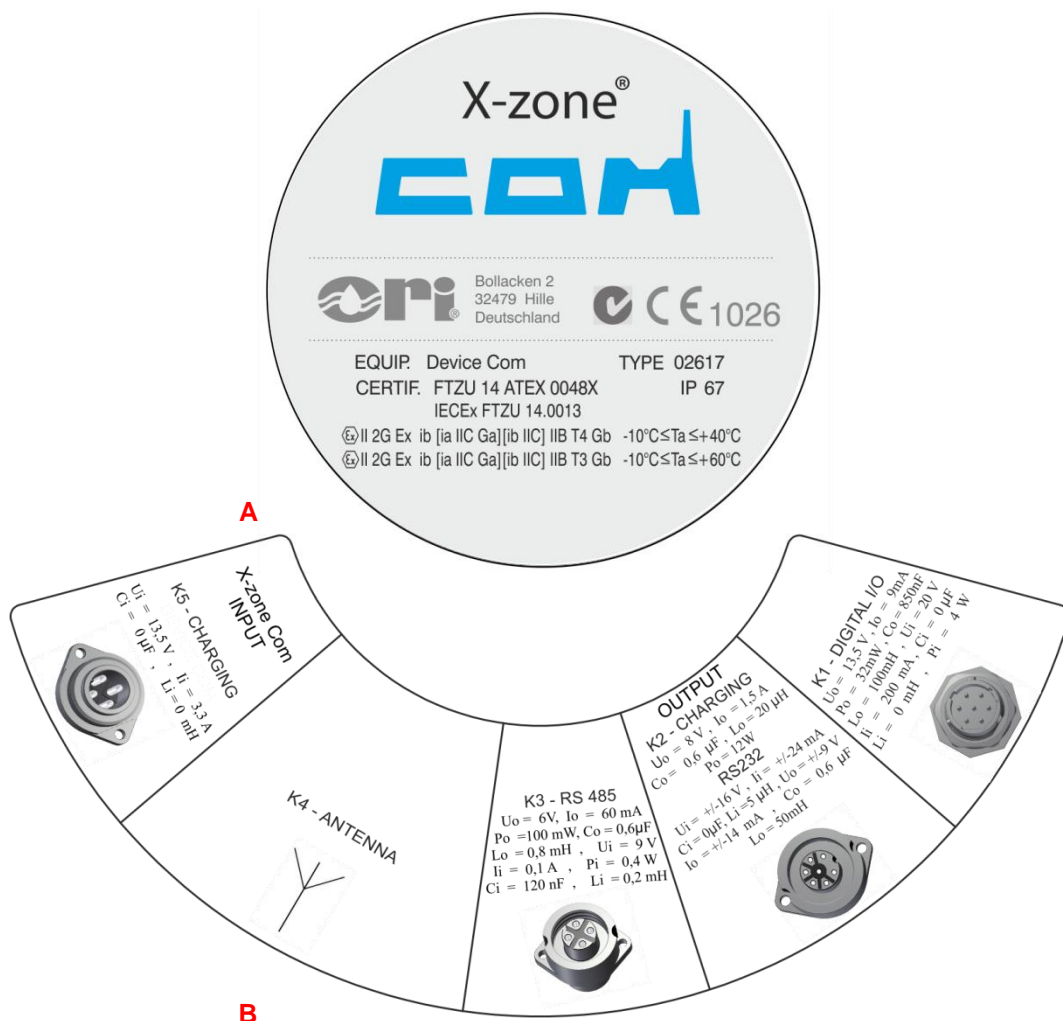

Fig. 3.5: **A)** Plaque signalétique du X-zone Com sur le dessus du boîtier.  
**B)** Informations sur le branchement sur le dessous du boîtier.

## 3.4 SPÉCIFICATIONS DE L'APPAREIL

### 3.4.1 X-zone Com

Données techniques : X-zone Com		
Identification ATEX / IECEx	IECEx FTZU 14.0013X FTZU 14 ATEX 0048X	Ex ib [ia IIC Ga] [ib IIC] IIB T3/T4 Gb ⊕ II 2G Ex ib [ia IIC Ga] [ib IIC] IIB T3/T4 Gb
Classe de protection IP	<b>IP 67</b>	(avec connecteurs fermés)
Dimensions (ØXH); Poids	362 x 238 mm; 9,8 kg	(sans Dräger X-zone 5x00)
Plages de température	<b>Température ambiante</b> <b>Température de stockage</b> <b>Charge, fonctionnement en mode tampon</b>	-10°C .. + 60°C, groupe de température T3 -10°C .. + 40°C, groupe de température T4 -20°C .. + 60 °C (sans batterie) 0°C .. +50°C (batterie) 0°C .. + 50°C (chargeur) +5°C .. +30°C (temps de chargement 30 h.) (avec arrêt automatique du chargement pour des températures de batterie en dessous de 0°C et supérieures à +45°C)
Humidité relative de l'air	5 - 95%	
Mémoire de données interne	8 MB – env. 262000 champs de données	
Batterie interne (Type NiMh)	Tension nominale de sortie Tension maximale de sortie Courant nominal de sortie Capacité Rechargeable en interne avec	12 V 15 V 0,92 A 13,5 Ah 9...15 VDC / 1,5A
Communication sans fil	<b>Bluetooth</b> <b>GSM/GPRS</b> <b>Antenne</b> (en atelier)	v3.0; class 1 (Antenne interne), 4dBm ERP Type MgsM Modem Quadribande 850/900/1800/1900 MHz Bi-bande 900 /1800 MHz
Interfaces physiques à sécurité intrinsèque	<b>1 x RS485 (K3)</b> <b>1 x RS232 (K2)</b> <b>1 x DI/DO (K1)</b> <b>1 x K5</b> <b>1 x HF 7/16 DIN (K4)</b>	Branchement Dräger X-zone 5x00 RS232 + chargement appareils externes en option pour Switch ON/OFF Box en option Alimentation/chargeur X-zone Com Antenne
Module GPS	Avec antenne interne	
Display	OLED	
Normes harmonisées appliquées	ETSI EN 300 328 V1.7.1:2006; ETSI EN 301 489-1 V.1.8.1:2008 : ETSI EN 301 489-7/V1.3.1:2005; ETSI EN 301 489-17/ V2.1.1:2009; ETSI EN 301511 V9.02:2003; EN 60079-0: 2012; EN 60079-11:2012; EN 60079-26: 2007 EN 50581:2012; EN 60950-1:2006; EN 61000-6-2:2005; EN 61000-6-3:2007	
Directive EU appliquée	94/9/EC - ATEX 2004/108/EC - EMC 1999/5/EC - R&TTR	

## 3.4.2 Chargeur

Données techniques : Chargeur I.S. Power Supply Unit 0217PS		
Classe de protection IP	IP 65	⊕ II (2)G [Ex ib Gb] IIB
Classe de protection électrique	I	
Dimensions (L x l x H); poids		425 x 90 x 100 mm without cable 3300 ± 50 x 90 x 100 with cable 1 kg
Température ambiante pendant le chargement		+5°C..+30°C ( <i>temps de chargement 30 h.</i> ) ( <i>avec arrêt automatique du chargement pour des températures de batterie en dessous de 0°C et supérieures à +45°C</i> ) )
Humidité relative de l'air	≤ 90%	
Données électriques	<b>Tension d'entrée</b>	90-230 VAC; 47 - 63 Hz 135-370 VDC; 1 A
	<b>Tension nominale de sortie</b>	12 VDC (nominal)
	<b>Courant nominal de sortie</b>	2 A (continu)
Spécifications à sécurité intrinsèque	<b>Uo</b>	13.5 V
	<b>Io</b>	2.8 A
	<b>Co</b>	50 nF
	<b>Lo</b>	30 μH

## 4 MONTAGE ET MISE EN SERVICE

Lors de sa première mise en service, le X-zone Com doit être configuré au moyen d'un logiciel PC (ORI Manager Software). La façon d'installer le Manager Software sur votre PC est expliquée ci-dessous. Après cela, les étapes mécaniques sont décrites pour la mise en service du X-zone Com.

### 4.1 INSTALLATION DU LOGICIEL DE GESTION

#### 4.1.1 Pré-requis système

Les conditions suivantes doivent être remplies pour pouvoir installer le Manager Software :

- Système d'exploitation Microsoft Windows XP / Vista / 7 / 8 - 32bit ou 64bit
- Microsoft .NET Framework installé
- Env. 10 MB de disque dur (sans .NET Framework)

#### REMARQUE



*Le Microsoft .NET Framework se télécharge gratuitement depuis le site Internet de Microsoft. Faites attention à télécharger la bonne version pour votre système d'exploitation (32 Bit ou 64 Bit). En cas de problèmes, merci de contacter votre spécialiste informatique.*

#### 4.1.2 Installation du Manager Software

Insérez le CD, le processus d'installation démarre automatiquement. Si l'installation ne se lance pas d'elle-même, exécutez le fichier "setup.exe" ou "manager\_setup.msi" depuis votre support d'installation et suivez les instructions.

#### REMARQUE



*Ce programme est protégé par la loi sur les droits d'auteur et les accords internationaux. Toute reproduction ou distribution non autorisée de tout ou partie de ce programme est interdite.*

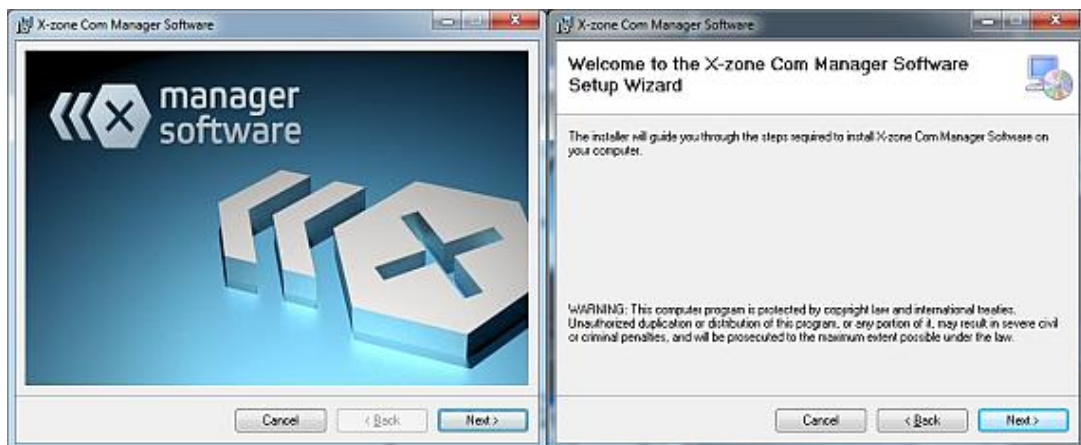

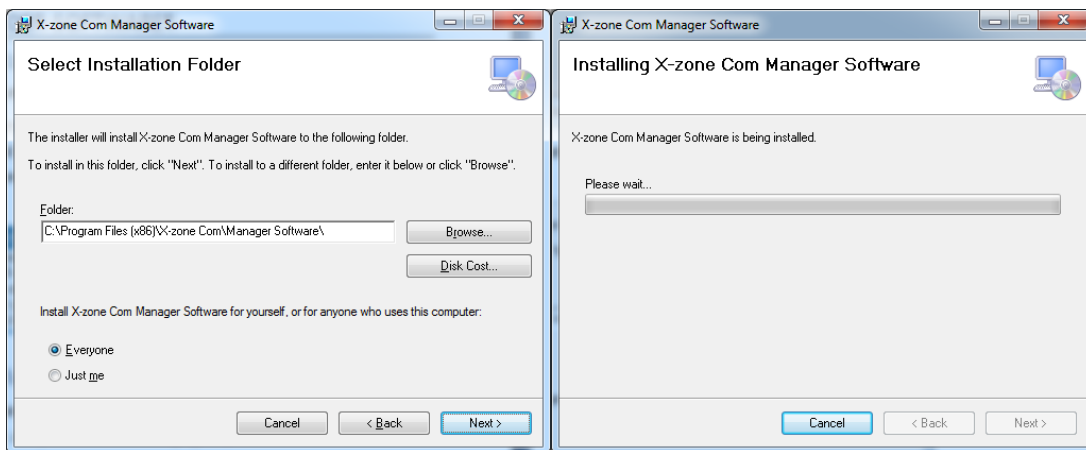

Fig. 4.1: Assistant d'installation de Manager Software.

Le Manager Software est installé par défaut dans le répertoire suivant :

```
c:\Program Files (x86)\X-zone Com\Manager Software\
```

Pour sélectionner un autre répertoire, cliquez sur [Browse...] ou saisissez directement l'emplacement dans le champ de texte sous "Folder:"

En sélectionnant [Everyone], l'installation s'effectue pour tous les utilisateurs du PC.

En sélectionnant [Just me] l'installation du logiciel s'effectue uniquement pour l'utilisateur en cours de connexion.

Pour installer le programme dans ce répertoire, cliquez sur [Next>]. Un raccourci est créé automatiquement sur le bureau.

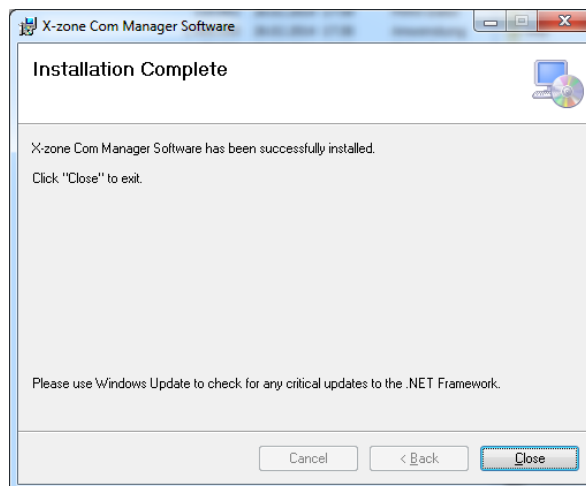

Fig. 4.2: Installation réussie.

Une fois l'installation achevée avec succès, fermez les assistants d'installation en cliquant sur [Close].

## 4.2 PREMIÈRE MISE EN SERVICE



Le montage, le branchement électrique, la mise en service, l'utilisation et l'entretien du X-zone Com ne peuvent être réalisés que par le personnel qualifié.

Le personnel qualifié doit avoir lu et compris le mode d'emploi. Lors de l'installation, du fonctionnement, de l'entretien et du transport, portez les vêtements de protection prescrits. Avant d'allumer le système, vérifiez à nouveau que les branchements sont corrects.

### 4.2.1 Chargement de la batterie

Lors du chargement du X-zone Com, le branchement du bloc d'alimentation/chargeur (ci-après dénommé bloc secteur) sur la tension d'alimentation doit se trouver en dehors d'une atmosphère explosive et de la zone explosive signalée. En outre, avant de brancher le bloc d'alimentation/chargeur sur la tension d'alimentation, assurez-vous que celle-ci coïncide avec la valeur indiquée sur la plaque signalétique. Pour finir, branchez le bloc secteur sur la sortie K5 du X-zone Com (voir chap. 4.2.4).

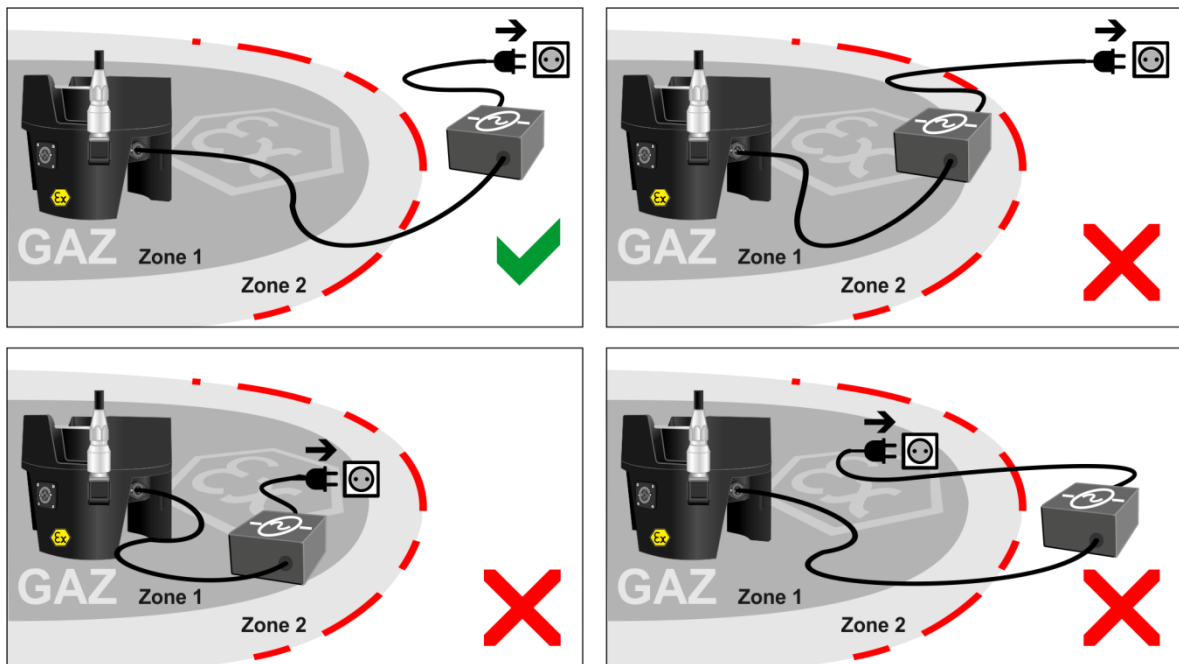

Fig. 4.3: Le branchement du chargeur et du bloc d'alimentation du X-zone Com avec la tension d'alimentation doit toujours avoir lieu en dehors des zones explosives signalées.

Pendant le processus de chargement, la température ambiante devrait se situer entre +5°C et +30°C, autrement ce processus peut se prolonger (voir également à ce sujet le chapitre 6.4).

### AVERTISSEMENT



#### Risque d'explosion !

Lors du chargement du X-zone Com, ne pas brancher le bloc secteur sur la tension d'alimentation au sein de la zone ATEX.

### REMARQUE



Veillez à ce que la batterie soit chargée complètement de façon régulière (maximum tous les 6 mois). Sinon, il y a risque de décharge totale et d'endommagement de la batterie. Stockez le X-zone Com déchargé avec le bloc secteur raccordé en dehors de la zone ATEX.

Le chargement du X-zone Com est visible sur l'écran par le biais d'un remplissage cyclique de batterie (voir chap. **Fehler! Verweisquelle konnte nicht gefunden werden.**)

#### Significations :

1. Décharger la batterie (X-zone Com s'éteint).
2. Lorsque la batterie est branchée sur le chargeur, le symbole représente une surchauffe et un arrêt temporaire du chargement. Lorsque la température de la batterie redescend, le chargement se poursuit.



Batterie chargée à 100%

## 4.2.2 Insertion de la carte SIM

Pour pouvoir utiliser le X-zone Com pour l'envoi d'e-mails ou de SMS, une carte SIM doit être insérée dans le modem interne.

Pour utiliser le modem GSM, il faut utiliser des cartes SIM M2M, fournies par l'acheteur, adaptées à la communication données et SMS. Concernant le volume de données et le nombre de SMS nécessaire, l'acheteur doit lui-même choisir en amont des contrats adaptés avec son fournisseur d'accès. Les cartes SIM, qui conviennent également à la communication vocale (valable aussi pour les cartes Twin) ou conçues principalement pour être utilisées dans un Smartphone, une tablette ou une clé USB/GSM, doivent être testées et activées en amont avec un Smartphone/une tablette/une clé USB GSM correspondants. Dans ce cas, les services comme le « Transfert de services vocaux » ou similaire devraient être désactivés. La carte SIM ne peut être également utilisée dans le modem GSM du X-zone Com qu'une fois l'activation/l'adaptation réussie.

## AVERTISSEMENT



### Risque d'explosion !

Ne pas ouvrir les boîtiers des produits au sein d'une atmosphère explosible !

L'insertion ou le retrait d'une carte SIM ne peut s'effectuer que dans un environnement non explosible.

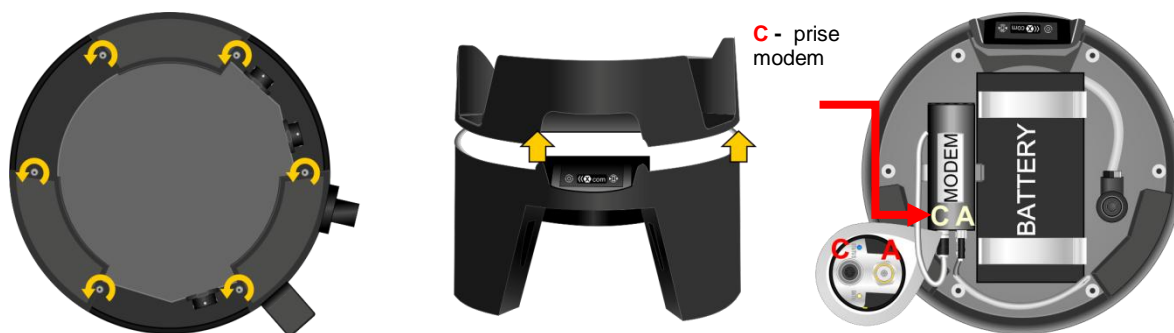

Fig. 4.4: ouverture boîtier X-zone Com (C=connecteur, A = prise antenne).

## REMARQUE



Avant d'ouvrir le boîtier du modem, débranchez le modem en retirant la prise d'alimentation.

Pour insérer une carte SIM, suivez les étapes suivantes :

1. Desserez les 6 vis sous le X-zone Com.
2. Retirez avec précaution le dessus du X-zone Com.
3. Débranchez le modem.
4. Si besoin, défaire le modem de son étrier.
5. Dévissez le couvercle du modem (voir Fig. 4.5).
6. Défaire le verrouillage du support de carte en le poussant dans le sens de la flèche, puis l'ouvrir (voir Fig. 4.5).
7. Mettre la carte SIM dans le support prévu à cet effet.
8. Rabattre le support de carte et le revérouiller en le repoussant dans le sens opposé.
9. Revisser le couvercle du modem.
10. Rebranchez l'alimentation électrique du modem.
11. Remettre le dessus (en veillant à ce que le joint soit bien en place).
12. Remettre les 6 vis en les serrant manuellement.



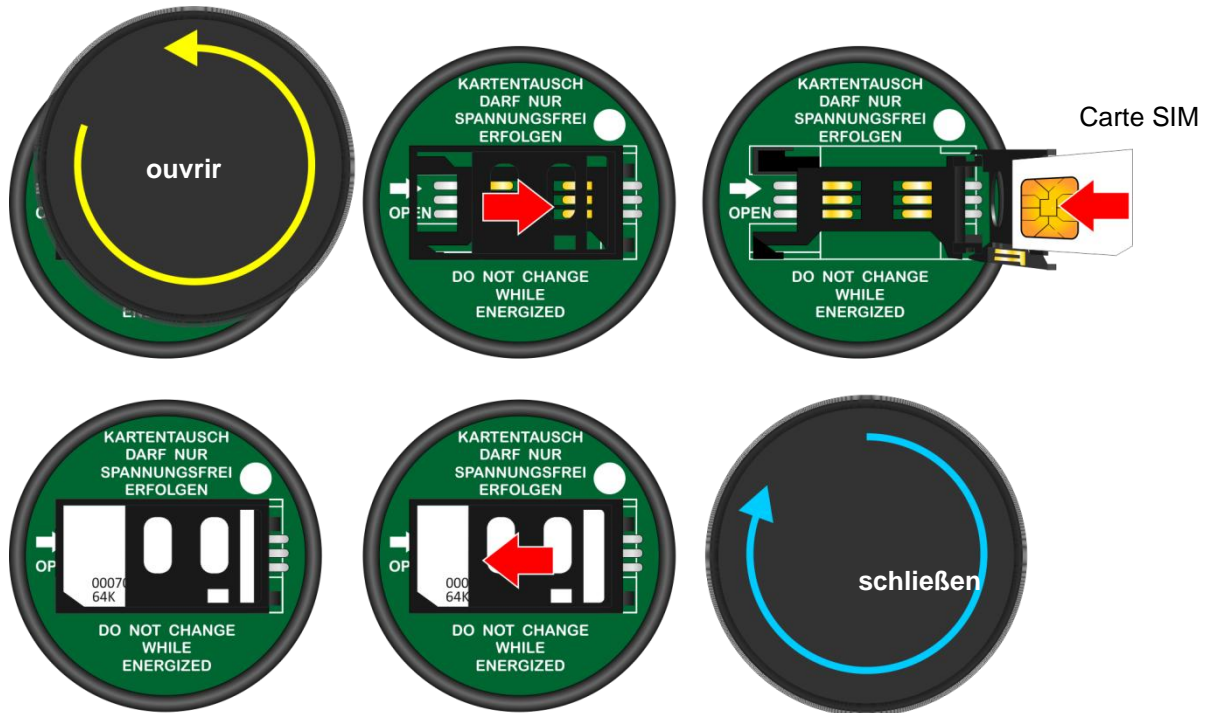

Fig. 4.5: Mise en place de la carte SIM. Dévisser le couvercle du modem, pousser le support de carte dans le sens de la flèche puis l'ouvrir.

### 4.2.3 Montage et démontage de l'antenne

**AVERTISSEMENT**

**Risque d'explosion !**  
Seule l'antenne originale peut être branchée sur la prise antenne (N° de commande ORI 8094108, N° de commande Dräger 8324372).

Lors du montage et du démontage de l'antenne, ne pas tourner la tige de l'antenne. Pour fixer ou desserrer, ne tourner que l'écrou-raccord, sinon le contact central dans la base de l'antenne risque de se défaire (Fig. 4.6).



Fig. 4.6: Prise HF du X-zone Com

## 4.2.4 Raccordement avec le X-zone 5x00

Utilisez le câble de raccordement RS485 livré avec le marquage jaune RS485 (article n° 8094118) pour relier la sortie K3 du X-zone Com avec le branchement XEXT2 du X-zone 5x00. Veillez à ce que la fiche coudée sur le X-zone Com soit vers le bas.

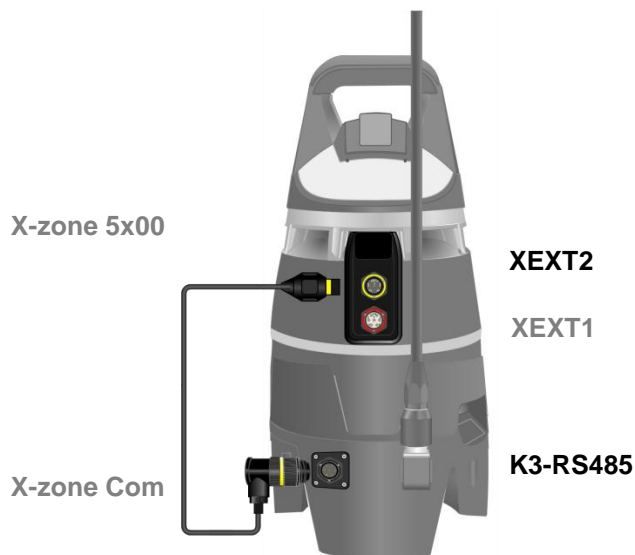

Fig. 4.7: Raccordement du X-zone Com avec le X-zone 5x00 à l'aide du câble de raccordement RS485.

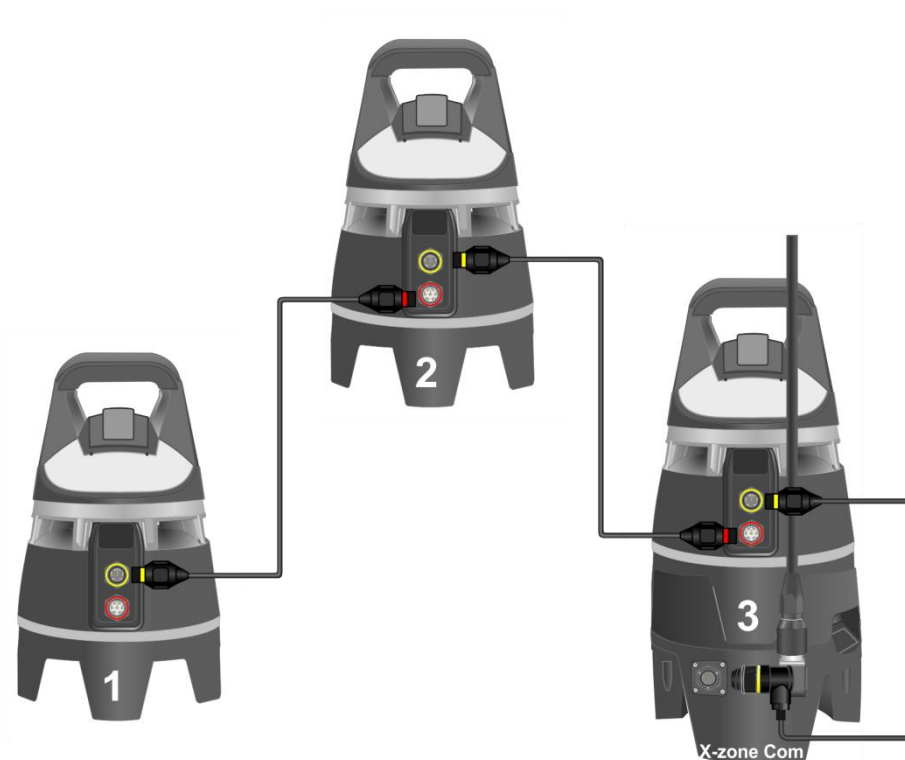

Fig. 4.8: Pour associer plusieurs X-zone 5x00 avec uniquement des câbles de communication, le X-zone Com est branché sur le X-zone 5x00 en bout de chaîne.

**REMARQUE**



L'utilisation d'un X-zone Com suppose pour un X-zone 5x00 raccordé un micrologiciel à partir de la version 2.22.

Pour la mise à jour d'un micrologiciel et la configuration du X-zone 5x00 au moyen du logiciel PC Dräger CC-Vision, veuillez vous mettre en relation avec votre conseiller Dräger.

Veillez à ce que le protocole Modbus dans le X-zone 5x00 ait été enclenché et configuré comme suit à l'aide du logiciel PC Dräger CC-Vision :

X-zone 5x00 paramétrages Modbus	
Jonction Modbus	XEXT2
Adresse Modbus	2
Bauds	115200
Parité	Even

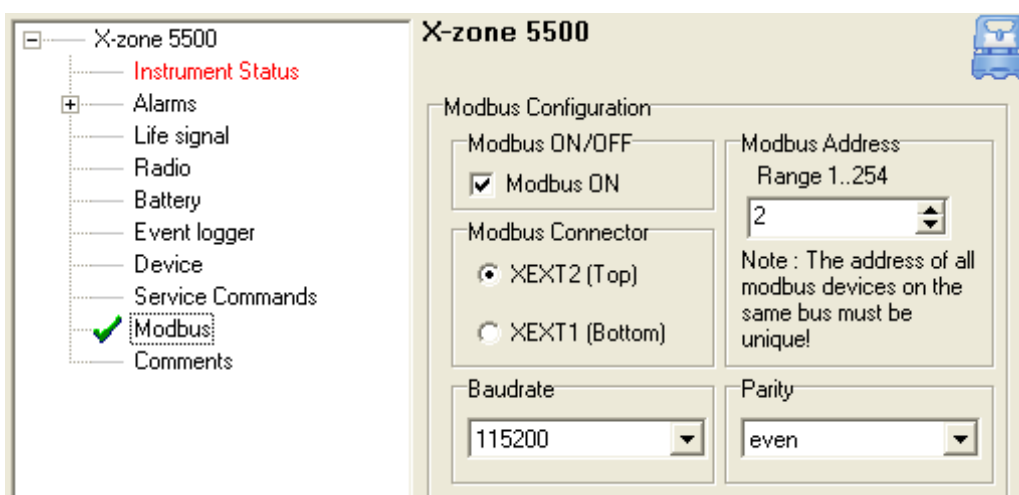

Fig. 4.9: Paramétrages Modbus au sein du logiciel PC Dräger CC-Vision.

**Différence entre un réseau fermé et un réseau ouvert :**

Vous trouverez un descriptif détaillé des fonctionnalités réseau dans le mode d'emploi du X-zone 5x00 de Dräger.

« Avec un réseau radio fermé, un appareil principal surveille la liaison radio vers tous les appareils du groupe et tous les appareils du groupe surveillent la liaison radio vers l'appareil principal. Lorsqu'un appareil est défaillant, par ex. du fait d'une batterie vide ou du retrait d'un appareil, une alarme est déclenchée sur l'appareil principal. Si c'est l'appareil principal qui est défaillant, une alarme se déclenche sur tous les appareils du groupe »

Le tableau suivant montre la différence de traitement par le X-zone Com. L'utilisation du numéro de série ou de poste ainsi que les valeurs mesurées localement ou valeurs maximales s'applique aussi bien pour les e-mails et SMS envoyés depuis le X-zone Com que pour le portail Internet Mcloud et le Manager Software.

	Réseau ouvert	Réseau fermé (groupe)
<b>Numéro d'identification du X-zone 5x00</b>	Numéro de série	ID au sein du groupe (numéro de poste)
<b>Valeur mesurée utilisée pour un gaz</b>	Valeur mesurée en cours du X-zone 5x00 raccordé	Valeur maximale en cours provenant du groupe
<b>Informations d'alarme</b>	✓	✓
<b>Nombre maximum de X-zone 5x00 dans le réseau</b>	25	15

#### REMARQUE



*Le X-zone Com peut être raccordé à n'importe quel X-zone 5x00 dans le réseau radio. Il n'est pas nécessaire de le brancher par ex. sur l'appareil principal dans le réseau fermé.*

#### REMARQUE



*Le X-zone Com envoie régulièrement un signal au X-zone. Si la connexion est interrompue plus d'une minute, le X-zone 5x00 signale un défaut appareil.*

### 4.3 DECONNEXION DU X-ZONE 5X00

Si la connexion entre le X-zone Com et le X-zone 5x00 est interrompue plus d'une minute, le X-zone 5x00 signale un défaut appareil. Pour éviter cela, laissez la connexion RS485 jusqu'à ce que vous éteigniez le X-zone Com (voir chap. 6.3). Avec cette façon de procéder, vous évitez un défaut appareil.

## 5 CONFIGURATION DU X-ZONE COM

Pour configurer le X-zone Com, vous avez besoin du Manager Software, dont l'installation est décrite au chapitre 4.1.

### 5.1 RÉALISATION D'UNE CONNEXION AVEC UN PC

Le X-zone Com est relié à un PC soit via une connexion Bluetooth sans fil soit par une connexion filaire.

#### 5.1.1 Connexion Bluetooth

La réalisation d'une connexion Bluetooth est décrite dans le paragraphe suivant à titre d'exemple pour Windows 7. En fonction du système d'exploitation, le processus peut légèrement varier.

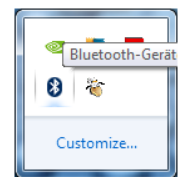

1. Assurez-vous que le module Bluetooth du PC est activé. Dans la plupart des cas, ceci s'effectue en appuyant sur les touches de fonction bleues [FN]+[symbole Bluetooth].
2. Assurez-vous que le X-zone Com est utilisé avec une batterie pleine.

Si le module Bluetooth est actif, cliquez avec le clic droit de la souris sur le symbole Bluetooth  dans la barre d'outils Windows et sélectionnez [Add a device] (ajouter appareil).

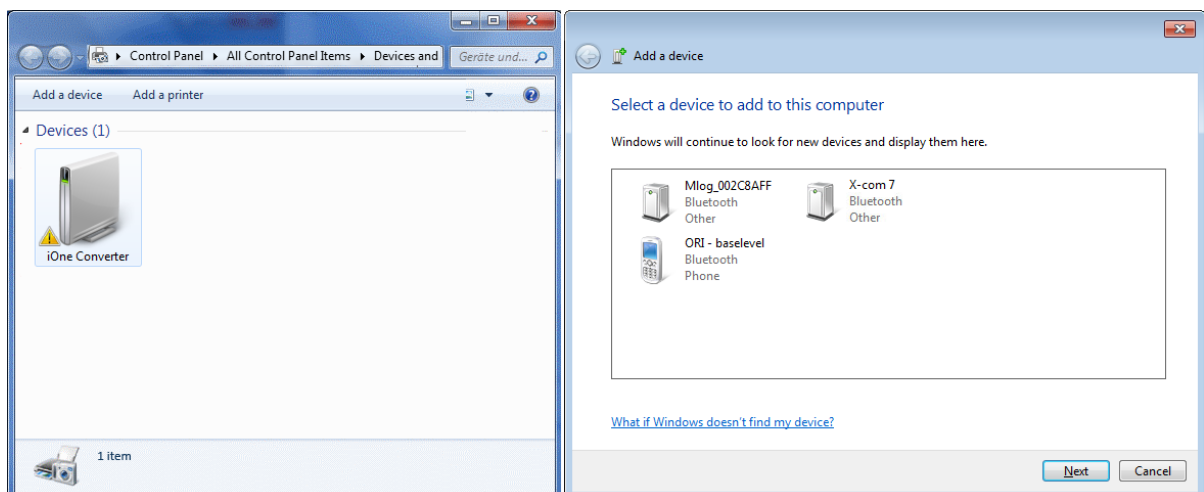

Fig. 5.1: Intégration Bluetooth du X-zone Com.

Sélectionnez ensuite l'appareil et cliquez sur [Continue](continuer). Si vous vous connectez pour la première fois au X-zone Com, confirmez alors le code de couplage affiché (pour MS Windows 7). En cliquant sur [Continue] (continuer), le X-zone Com est rajouté aux appareils du réseau Bluetooth du PC utilisé.

Chaque connexion Bluetooth installée se voit affecter par MS Windows un numéro de port COM. Pour voir le numéro, sélectionnez l'appareil et cliquez sur [Properties] (propriétés). Ensuite, sélectionnez le formulaire [Services] (voir Fig. 5.2).

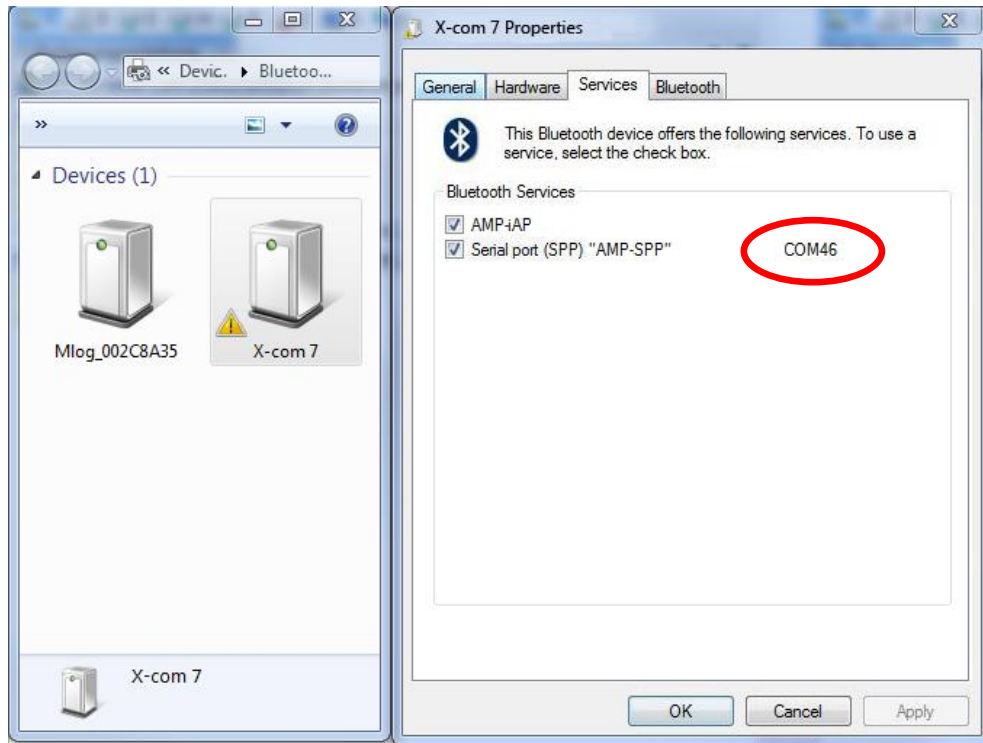

Fig. 5.2: Attribution Port COM pour MS Windows 7.

Le Manager Software peut trouver le port COM automatiquement; pour établir la connexion plus rapidement, le port COM peut être paramétré manuellement dans le Manager Software.

### 5.1.2 Connexion filaire

A la place de la connexion Bluetooth, le X-zone Com peut être relié à un PC par le biais de l'interface K2 (RS232) via le câble fourni. Pour cela, un adaptateur série USB est habituellement nécessaire.

Le numéro de port COM attribué par MS Windows COM doit dans ce cas également être utilisé par le Manager Software (paramétré automatiquement ou manuellement).

## 5.2 VUE D'ENSEMBLE/VUE DE DÉMARRAGE

La fenêtre principale du Manager Software comporte cinq zones de fonctions, décrites ci-dessous.

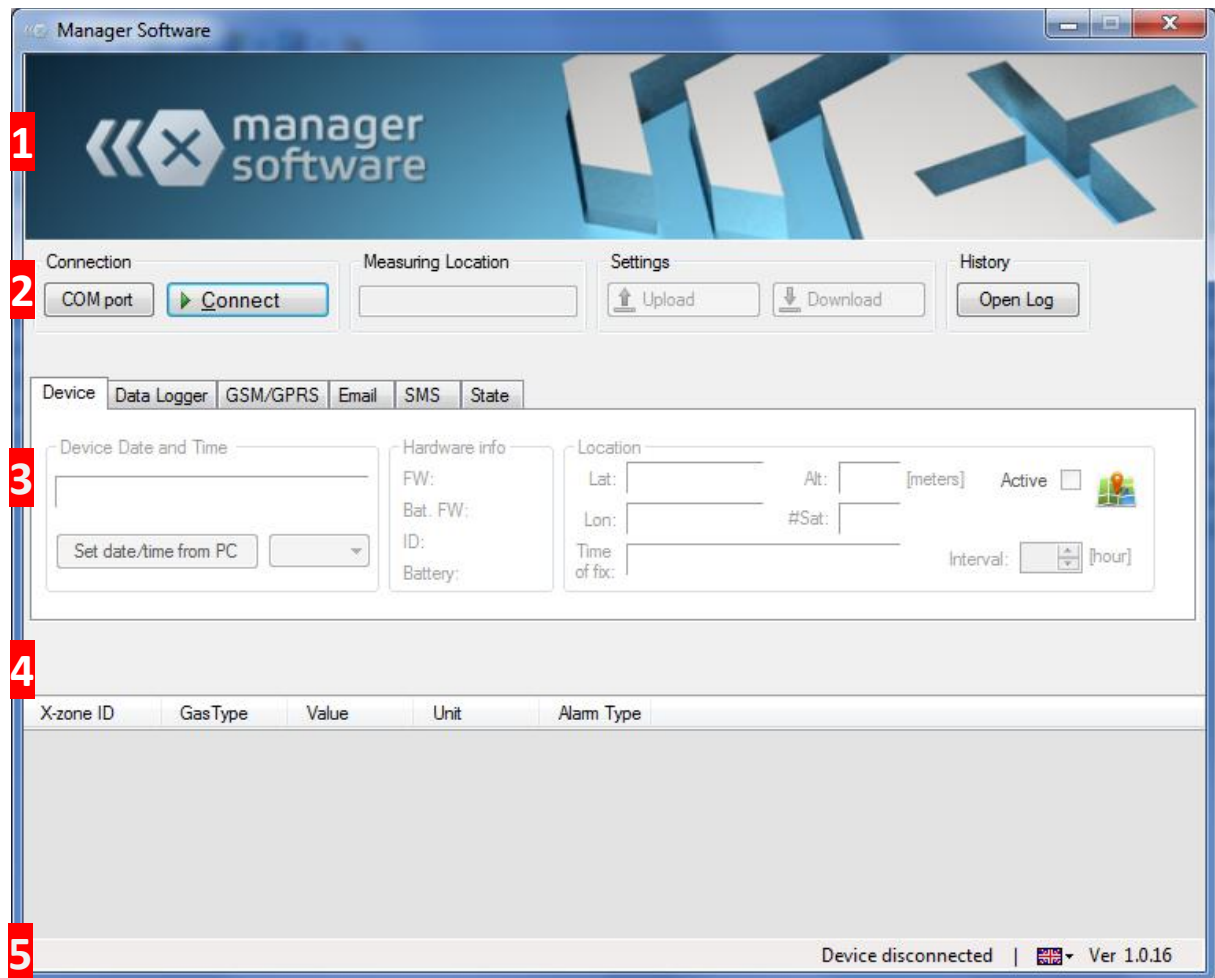

Fig. 5.3: fenêtre de démarrage du Manager Software.

<b>1</b>	<p><b>Logo</b></p> <p>Le logo est relié au site de ORI (<a href="http://www.origmbh.de/">http://www.origmbh.de/</a>) (accès Internet requis).</p>
<b>2</b>	<p><b>Informations de connexion</b></p> <p><b>Connexion :</b></p> <p>[COM-Port]: sélection du port COM          [Connect] (connecter): établit une connexion entre le PC et le X-zone Com.          [Disconnect] (quitter): arrête la connexion.</p> <p><b>Nom de l'appareil :</b></p> <p>Nom de l'appareil défini par l'utilisateur du X-zone Com.</p> <p><b>Paramétrages :</b></p> <p>[Upload](enregistrer) : enregistrer les paramètres dans le X-zone Com.          [Download](charger) : lire les paramètres actuels à partir de l'appareil et les afficher.</p> <p><b>Historique des données :</b></p> <p>[Open Log] (afficher) Chargement de fichiers de données BSH pour la visualisation des données. Fonction exportation.</p>

3	<p><b>Zone de configuration</b></p> <p>Mettre les paramètres appareil, connexion et communication. Différentes informations telles que l’ID appareil, le statut de l’appareil et l’état de la batterie sont en plus visibles.</p>
4	<p><b>Zone des valeurs mesurées :</b></p> <p>Avec un réseau fermé, les valeurs mesurées en cours du X-zone 5x00 raccordé localement sont affichées. En cas d’alarme, les valeurs de l’alarme de l’appareil émettant l’alarme s’affichent en plus.</p> <p>En réseau fermé, les valeurs d’alarme et maximales actuelles en provenance du groupe s’affichent.</p>
5	<p><b>Barre d’état</b></p> <p>Affiche l’état de la connexion vers le X-zone Com.</p> <p>D’autre part, il est possible de choisir la langue du Manager Software et de consulter la version du Manager Software.</p>

## 5.3 INFORMATIONS DE CONNEXION

### 5.3.1 Établissement d’une connexion vers le X-zone Com

Une connexion entre le PC et le X-zone Com peut s’effectuer soit par le biais du câble RS232 ou en Bluetooth. Si la connexion se fait par le câble RS232, c’est en règle générale le port COM 1 qui est attribué.

**REMARQUE**



Pour une connexion réussie en Bluetooth, le module Bluetooth du PC doit être actif et un ComPort virtuel doit avoir été attribué à l’appareil par le système d’exploitation. Vous trouverez plus de détails dans le chap. 5.1

Le Manager Software peut rechercher automatiquement le port COM pour la connexion série en Bluetooth ou bien vous faites l’affectation manuellement.

#### 5.3.1.1 Recherche automatique

La recherche automatique du port COM constitue le réglage par défaut une fois le logiciel installé. [AutoDetect] (recherche automatique) doit être coché – comme indiqué sur la Fig. 5.5.

Cliquez sur [Connect] (connecter) pour démarrer la procédure de connexion. „Searching device at“ (recherche l’appareil sur) apparaît dans la barre d’état ainsi que l’information indiquant sur quel port COM l’appareil est recherché.

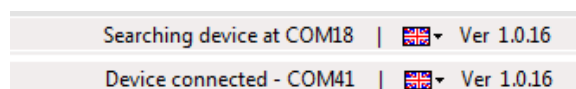



Fig. 5.4: Barre d’état du Manager Software pour une connexion réussie.



### 5.3.1.2 Sélection manuelle du port COM

**REMARQUE**

 Une sélection manuelle du ComPort est toujours judicieuse lorsque vous possédez plusieurs X-zone Com, car sinon une connexion est toujours établie avec le premier X-zone Com trouvé.

Pour sélectionner manuellement le numéro de port COM attribué par le système d'exploitation, cliquez sur le bouton [COM port]. Il ouvre la fenêtre "COM Port" représentée ci-dessous. Décochez [Auto-Detect] (recherche automatique) et sélectionnez ensuite dans la liste le numéro de port COM attribué par le système d'exploitation pour le X-zone Com.



Fig. 5.5: Sélection manuelle du port COM de l'interface Bluetooth ou série.

### 5.3.2 Désignation de l'appareil / Modifier le nom du lieu de mesure

Un nom défini par l'utilisateur peut être affecté au X-zone Com sous "Measuring Location" (nom appareil) (par ex. un lieu de mesure). Ne sont pas admis les caractères: „§“, „°“, les trémas allemands et le „ß“. C'est sous ce nom que s'affichent toutes les valeurs mesurées transférées dans le Mcloud ORI. En cas de livraison départ usine, le nom de l'appareil correspond à l'ID appareil du X-zone.

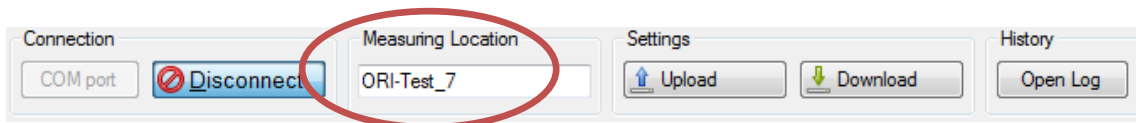



Fig. 5.6: Attribution d'un nom au X-zone Com.

En cliquant sur [Upload] (enregistrer), le nom est inscrit dans le X-zone Com. Il est possible de rentrer 10 caractères maximum pour le nom. Les trémas et caractères spéciaux ne sont pas admis. Si aucun nom ou aucun nom valide n'a été attribué, les paramètres ne peuvent pas être transférés et un message d'erreur apparaît.

**REMARQUE**

 Le nom d'appareil attribué est nécessaire à l'enregistrement du X-zone Com dans le Mcloud.

### 5.3.3 Enregistrement et chargement des paramètres X-zone Com

Les paramétrages réalisés sont enregistrés dans le X-zone Com par le biais de [Upload] (enregistrer), dans la mesure où toutes les saisies sont valables. Les saisies non valables sont marquées en rouge et leur enregistrement n'est pas possible.

En cliquant sur [Download] (charger), les paramètres actuels sont lus à partir du X-zone Com et affichés par le Manager Software.

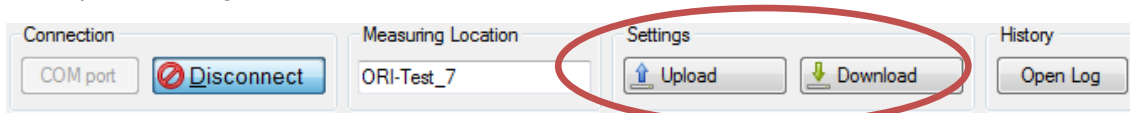



Fig. 5.7: Transfert ou lecture des paramétrages dans le X-zone Com.

### 5.3.4 Afficher l'historique des données

**REMARQUE**

 Pour pouvoir utiliser l'historique des données dans le Manager Software, vous ne devez pas être connecté au X-zone Com.

Après avoir appuyé sur [Open Log] (afficher) dans "History" (historique des données), une fenêtre apparaît pour ouvrir les fichiers de données envoyés par e-mail. Pour sélectionner un champ de données mesurées, appuyer sur le bouton [...] et sélectionner le fichier correspondant. En cliquant sur [Download] (charger), les mesures du fichier sélectionné s'affichent dans un tableau dans le formulaire [Data] (données).

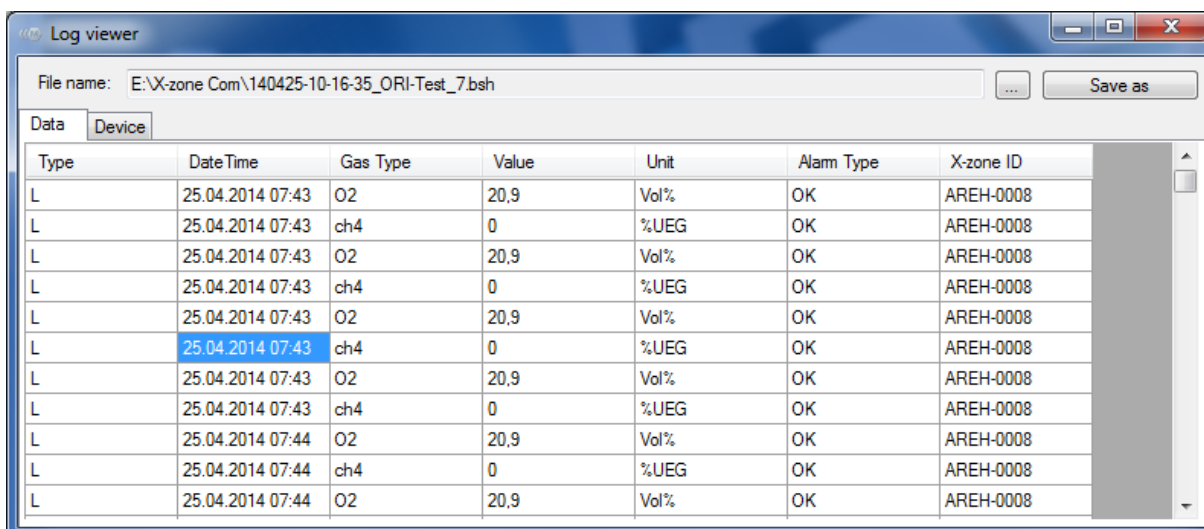
The screenshot shows a 'Log viewer' window with a file name 'E:\X-zone Com\140425-10-16-35\_ORI-Test\_7.bsh'. It contains a table with columns: Type, DateTime, Gas Type, Value, Unit, Alarm Type, and X-zone ID. The table lists 14 rows of data for O2 and ch4 measurements at 20.9 Vol% and 0 %UEG respectively, all with 'OK' alarm types and 'AREH-0008' X-zone ID.

Type	DateTime	Gas Type	Value	Unit	Alarm Type	X-zone ID
L	25.04.2014 07:43	O2	20,9	Vol%	OK	AREH-0008
L	25.04.2014 07:43	ch4	0	%UEG	OK	AREH-0008
L	25.04.2014 07:43	O2	20,9	Vol%	OK	AREH-0008
L	25.04.2014 07:43	ch4	0	%UEG	OK	AREH-0008
L	25.04.2014 07:43	O2	20,9	Vol%	OK	AREH-0008
L	25.04.2014 07:43	ch4	0	%UEG	OK	AREH-0008
L	25.04.2014 07:43	O2	20,9	Vol%	OK	AREH-0008
L	25.04.2014 07:43	ch4	0	%UEG	OK	AREH-0008
L	25.04.2014 07:44	O2	20,9	Vol%	OK	AREH-0008
L	25.04.2014 07:44	ch4	0	%UEG	OK	AREH-0008
L	25.04.2014 07:44	O2	20,9	Vol%	OK	AREH-0008

Fig. 5.8: Vue du tableau des données mesurées d'un fichier de données BSH chargé dans le visionneur de données.

Signification de quelques colonnes du tableau :

Colonne	Valeur	Signification
Type	L	Valeur locale mesurée
	M	Valeur maximale du gaz dans le groupe
	E	Erreur

Valeur		Valeur gaz mesurée enregistrée
Unité	Vol%, %UEG, %LEL, %LIE, ppm, mg/m3, ppb, mbar, hPa, kPa, mg/L	Unités des valeurs mesurées
Type d'alarme	OK	Valeur mesurée dans la plage normale
	A1	A1 Alarme
	A1_Q	A1 Alarme acquittée
	A2	A2 Alarme
	A2_Q	A2 Alarme acquittée
	Err	Défaut appareil
	Err_Q	Défaut appareil acquitté

Pour exporter des champs de données dans un fichier CSV, activez le bouton [Save as] (enregistrer sous). Sélectionnez ensuite le classeur où le fichier doit être enregistré et décidez si les données doivent être ouvertes dans le tableur installé sur votre PC.

Choisissez le formulaire [Device] (appareil) pour voir les informations contenues dans le fichier de données sur l'appareil, le GPS, les alarmes et les capacités batterie.

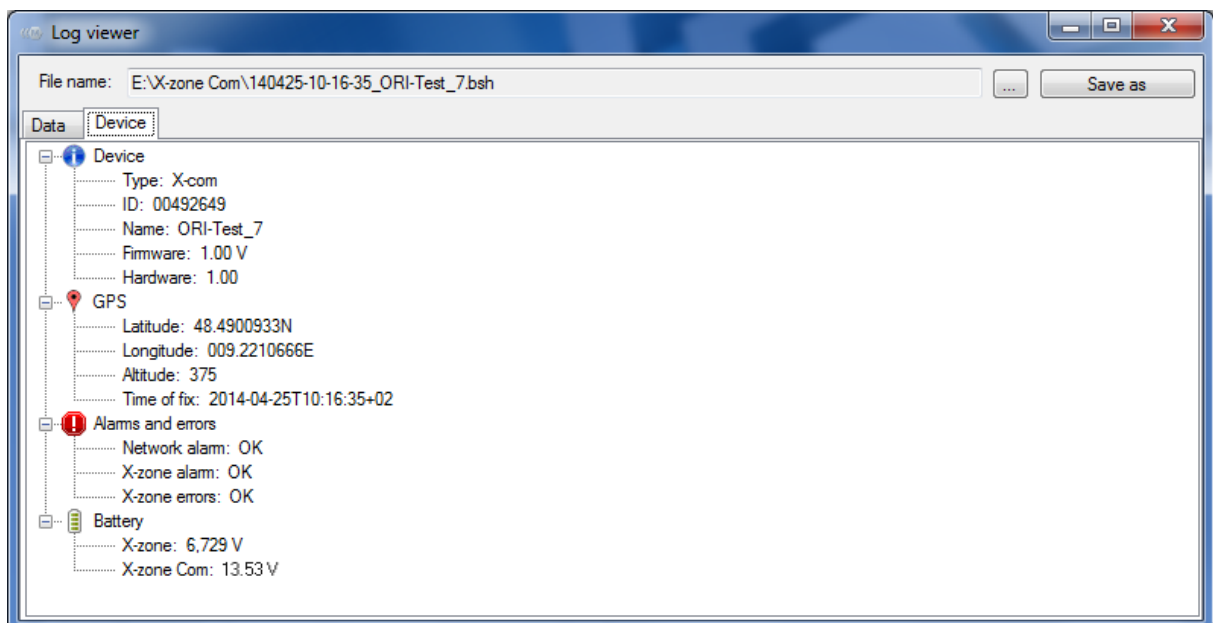

Fig. 5.9: Informations concernant le X-zone Com au moment du transfert du fichier BSH dans le formulaire récapitulatif [Device] (appareil) du visionneur de données.

## 5.4 CONFIGURATION DU X-ZONE COM

Dans la zone configuration de la fenêtre, les paramètres en cours du X-zone sont affichés. Les différents formulaires sont détaillés ci-dessous.

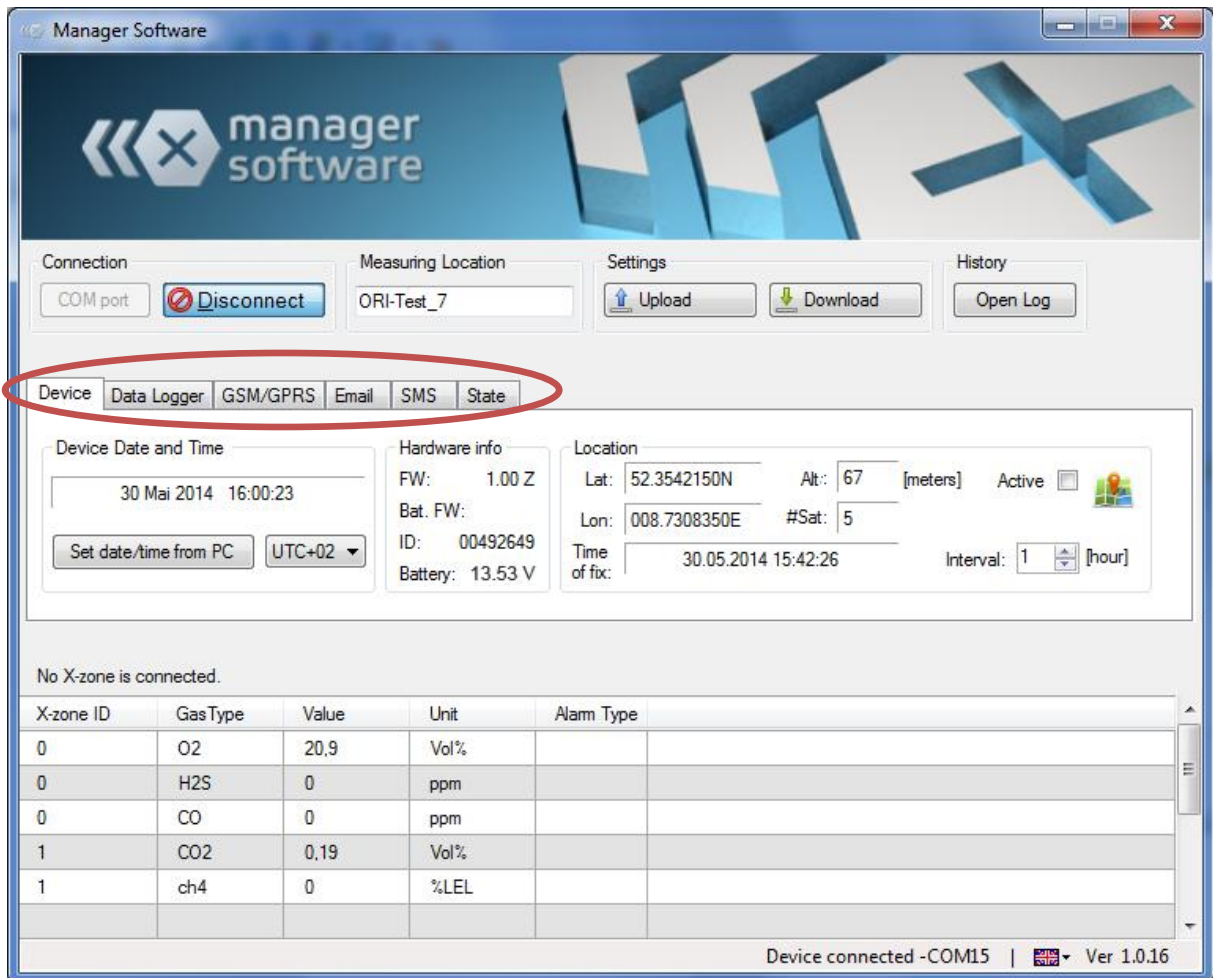

Fig. 5.10: Les différents formulaires pour les paramètres généraux, les paramètres de l'enregistreur de données, du GSM, e-mail et SMS.

A l'exception de la date de l'appareil, et de l'heure de l'appareil, tous les paramètres effectués doivent être transférés vers le X-zone com avec le bouton [Upload] (enregistrer) (paramétrages).

## 5.4.1 Formulaire "Appareil"

Dans le formulaire "Device", les valeurs et informations générales des appareils peuvent être consultées et saisies.

The screenshot shows a web interface for device configuration. It has several tabs: 'Device', 'Data Logger', 'GSM/GPRS', 'Email', 'SMS', and 'State'. The 'Device' tab is active. The form is divided into three main sections:

- Device Date and Time:** Shows '30 Mai 2014 16:00:23'. There is a button 'Set date/time from PC' and a dropdown menu set to 'UTC+02'.
- Hardware info:** Shows 'FW: 1.00 Z', 'Bat. FW: 00492649', and 'Battery: 13.53 V'.
- Location:** Shows 'Lat: 52.3542150N', 'Alt: 67 [meters]', 'Lon: 008.7308350E', and '#Sat: 5'. There is a 'Time of fix: 30.05.2014 15:42:26' and an 'Interval: 1 [hour]' dropdown menu. An 'Active' checkbox is checked, and there is a small map icon.

Fig. 5.11: Informations générales de l'appareil comme par ex. l'heure en cours de l'appareil et les coordonnées GPS.

**Date/heure appareil :** L'heure affichée se compose du "Universal Time Coordinated [UTC]" et du fuseau horaire, par ex. pour l'Europe centrale :

1. Normal : UTC+1
2. Heure d'été : UTC+2

En cliquant sur le bouton [Set Date/time from PC] (date/heure du PC), la date et l'heure actuelles du PC s'enregistrent dans l'appareil. Ceci se fait en tenant compte du fuseau horaire sélectionné (UTC+1 en Europe centrale). La précision de l'horloge du PC doit être vérifiée au préalable.

**REMARQUE**

Dès qu'un signal GPS est reçu, l'heure GPS est utilisée. Quand l'horloge n'est pas paramétrée, les horodatages correspondent à la durée depuis la mise en route du X-zone Com, tant qu'aucune heure GPS n'est captée.

**Info :** La rubrique info indique le numéro de version du microprogramme, le numéro d'identification ainsi que l'état de charge du X-zone Com en volts.

**Location :** "Location" indique les données de position calculées, le nombre de satellites GPS utilisés ainsi que l'instant où cette position a été calculée. Avec "Interval" (intervalle), vous définissez dans quels intervalles un nouveau calcul de position GPS doit être réalisé, dans l'exemple toutes les heures (Fig. 5.11). Un intervalle GPS court réduit la durée de la batterie.

En cliquant sur le symbole carte, la position de l'appareil s'affiche dans Google Maps si les coordonnées existent. Pour cela, il faut qu'un moteur de recherche soit installé et une connexion Internet existante.

This is a close-up of the 'Location' section from the previous figure. It shows the following fields:

- Breite:** 52.3542150N
- Höhe:** 67 [Meter]
- Länge:** 008.7308350E
- #Sat:** 5
- Erfasst am:** 30.05.2014 15:42:26
- Interval:** 1 [Stunde(n)]

The 'Interval' dropdown menu is circled in red in the original image.

Fig. 5.12: Intervalle dans lequel la position est calculée.

## REMARQUE



L'intervalle peut être paramétré entre 0 et 24 heures. En mettant "0" le module GPS est désactivé en permanence.

Lors de la mise en route et dans l'intervalle paramétré, le X-zone Com tentera automatiquement de calculer les coordonnées GPS. En cochant la case [Aktiv] (actif), la détermination de la position démarre immédiatement.

Location	
Lat: 52.3542150N	Alt: 67 [meters]
Lon: 008.7308350E	#Sat: 5
Time of fix: 30.05.2014 15:42:26	Interval: 1 [hour]

Fig. 5.13: Démarrage du calcul de position en cochant la case.

Pendant le calcul de la position, la couleur de l'intitulé de la case [Active] (actif) passe du gris au noir. Une fois les paramètres GPS calculés, ce changement de couleur s'arrête et les données de position déterminées s'affichent. La case [Active] (actif) est activée et l'instant où la position est fixée "Time of fix" (saisie le) est mise. Une tentative d'affiner le résultat s'effectue alors pendant une minute. Ensuite, désactivez la case [Active] (actif) et le module GPS.

Toute tentative de déterminer une position est interrompue au bout de 10 minutes si aucune position n'a pu être trouvée. Ensuite, le module GPS s'arrête pour économiser de l'énergie. Si aucune position n'a pu être trouvée, c'est la dernière position trouvée qui continue à être utilisée. Le symbole GPS est rayé sur l'écran du X-zone Com (voir chap. 6.4.1).

## 5.4.2 Formulaire "Data Logger" (enregistreur de données)

Le X-zone Com mémorise toutes les mesures et les événements transmis par le X-zone 5x00. Il est possible de configurer la fréquence à laquelle les mesures doivent être transmises.

## REMARQUE



Tous les paramétrages réalisés doivent être transférés une fois vers le X-zone Com en cliquant sur [Upload] (enregistrer).

The screenshot shows a web interface with a top navigation bar containing 'Device', 'Data Logger', 'GSM/GPRS', 'Email', 'SMS', and 'State'. The 'Data Logger' tab is active. Below the navigation bar, there are three main sections: 'Interval' with a dropdown set to '10 [sec]', 'Status' with 'Unread: 25718' and 'Used: 10.29 %', and 'Data logger' with a 'Read:' dropdown and a 'Clear' button.

Fig. 5.14: dans le formulaire "Data logger", l'intervalle de connexion est défini, les informations sur le statut relatifs au stockage des données peuvent être consultées et la mémoire vidée.

**Intervalle :** Sous l'intitulé „Interval“ (intervalle) il est défini, dans quel intervalle les valeurs mesurées doivent être transmises et enregistrées. On choisit pour cela soit des secondes (10-59 sec.) soit des minutes (1-60 min.).

**Statut :** Le nombre de champs de données enregistrés est représenté au niveau de "total" (total) et le nombre de champs de données non encore enregistrés au niveau de "unread" (non lus). D'autre part, le niveau de la mémoire s'affiche.

**REMARQUE**

 L'enregistreur de données est de type circulaire, c'est à dire que lorsque la mémoire est pleine, ce sont les champs de données les plus anciens qui sont écrasés automatiquement.

**Enregistreur de données:** [Delete] (supprimer) vide la mémoire de l'appareil. Il y a une question de sécurité avant la suppression définitive.

### 5.4.3 Formulaire "GSM/GPRS"

Pour une communication de données réussie par le biais du réseau GSM/GPRS, plusieurs paramètres sont nécessaires. Ces données de connexion dépendent du prestataire en téléphonie mobile et doivent, si elles ne sont pas connues, être demandées à ce dernier.

**REMARQUE**

 Tous les paramètres réalisés doivent être transférés une fois vers le X-zone Com en cliquant sur [Upload] (enregistrer).

The screenshot shows a web interface with a top navigation bar containing 'Device', 'Data Logger', 'GSM/GPRS', 'Email', 'SMS', and 'State'. The 'GSM/GPRS' tab is active. Below the navigation bar, there are two main sections: 'Provider' with fields for 'APN: web.vodafone.de', 'User: vodafone', and 'Password: masked'; and 'SIM' with fields for 'Tel.: 01 239876543' and 'PIN: masked'. There is also a 'Modem status' button.

Fig. 5.15: Paramètres de téléphonie mobile. Les paramètres valables pour la carte SIM insérée sont à demander à votre prestataire en téléphonie mobile. En cliquant sur [Modem status] (statut modem), vous obtenez les paramètres de connexion et un test de fonctionnement est en plus réalisé

<b>APN</b>	Access Point Name de votre prestataire en téléphonie mobile, à saisir pour toute carte SIM nouvellement insérée  Ici quelques exemples de points d'accès en Allemagne (sans garantie)																				
	<table border="1"> <thead> <tr> <th>Prestataire</th> <th>Point d'accès APN</th> <th>User</th> <th>Mot de passe</th> </tr> </thead> <tbody> <tr> <td>T-Mobile</td> <td>internet.t-mobile</td> <td>t-mobile</td> <td>tm</td> </tr> <tr> <td>Vodafone</td> <td>web.vodafone.de</td> <td>non nécessaire</td> <td>non nécessaire</td> </tr> <tr> <td>O2</td> <td>internet</td> <td>non nécessaire</td> <td>non nécessaire</td> </tr> <tr> <td>EPLUS</td> <td>internet.eplus.de</td> <td>eplus</td> <td>internet</td> </tr> </tbody> </table>	Prestataire	Point d'accès APN	User	Mot de passe	T-Mobile	internet.t-mobile	t-mobile	tm	Vodafone	web.vodafone.de	non nécessaire	non nécessaire	O2	internet	non nécessaire	non nécessaire	EPLUS	internet.eplus.de	eplus	internet
Prestataire	Point d'accès APN	User	Mot de passe																		
T-Mobile	internet.t-mobile	t-mobile	tm																		
Vodafone	web.vodafone.de	non nécessaire	non nécessaire																		
O2	internet	non nécessaire	non nécessaire																		
EPLUS	internet.eplus.de	eplus	internet																		
<b>Utilisateur</b>	Nom utilisateur pour l'accès Internet																				
<b>Mot de passe</b>	Votre mot de passe pour l'accès Internet																				
<b>Tél.</b>	Numéro de téléphone de la carte SIM insérée. Entrée manuelle																				
<b>PIN</b>	N° PIN de la carte SIM placée dans le modem, si celle-ci dispose d'une protection. Sinon le champ reste vide. Il est requis lors de la mise en route/du chargement de l'appareil.																				

En cliquant sur [Modem status] (statut modem) une fenêtre d'information s'ouvre et le modem essaye d'établir une connexion réseau.

Dès qu'une adresse IP s'affiche, cela signifie que le test de fonctionnement du modem était concluant.

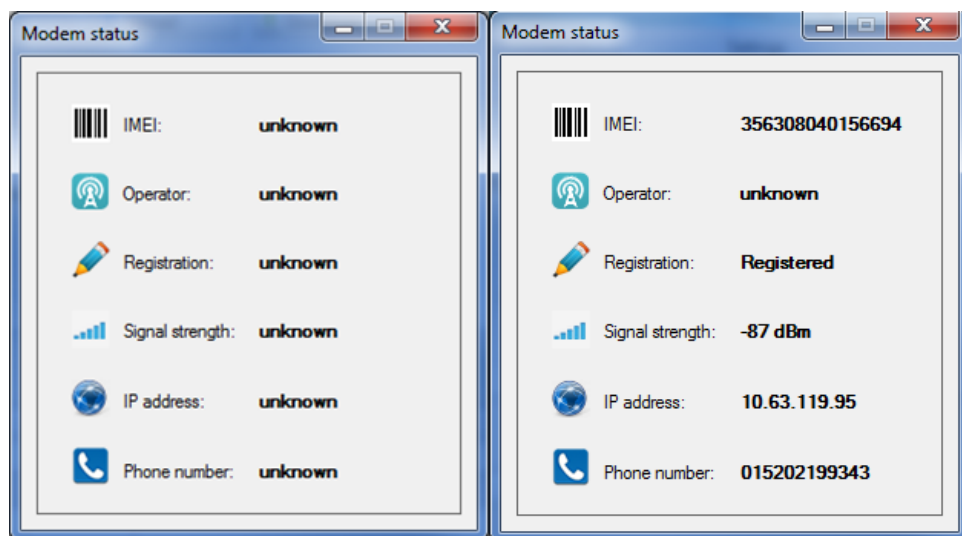



Fig. 5.16: La fenêtre vers le statut modem vous informe sur les paramètres de connexion.

#### 5.4.4 Formulaire "Email"

Le X-zone Com envoie des e-mails avec les mesures par cycles configurables. En cas d'alarme, l'envoi est immédiat. Dans les deux cas, les mesures et les alarmes non encore transférées sont envoyées.



**REMARQUE**  
 Tous les paramétrages réalisés doivent être transférés une fois vers le X-zone Com en cliquant sur [Upload] (enregistrer).

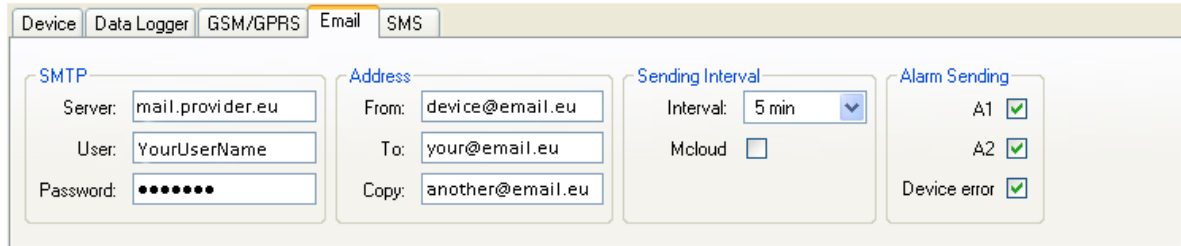

Fig. 5.17: Paramètres e-mail tels que le serveur SMT, les adresses d'envoi et de réception, l'intervalle d'envoi et pour quelles alarmes un e-mail doit être envoyé en plus.

**SMTP:** Les paramétrages nécessaires à l'envoi d'e-mails et l'utilisation de Mcloud sont effectués sous "SMTP".

<b>Serveur</b>	Adresse de votre serveur de courrier sortant
<b>Utilisateur</b>	Nom d'utilisateur pour l'accès aux e-mails
<b>Mot de passe</b>	Votre mot de passe pour l'accès aux e-mails

**Adresse:** Les adresses expéditeur/ destinataires sont enregistrées dans "Adresse".

<b>De</b>	Adresse expéditeur (définie par l'utilisateur selon les critères du fournisseur d'accès)
<b>A</b>	Destinataire e-mail (maximum un destinataire).
<b>Copie</b>	Destinataire e-mail (maximum un destinataire en copie).

**Intervalle d'envoi :** dans "Sending Interval" (intervalle d'envoi), vous paramétrez la fréquence des envois (5/10/15/30 min; 1/2/3/4/6/8/12 h;1 jour). Après enregistrement, le premier envoi d'e-mail est effectué à l'expiration de l'intervalle défini.

En cochant la case "Mcloud" les données sur Mcloud sont transférées (voir mode d'emploi séparé pour l'utilisation de Mcloud).

**l'envoi d'alarme:** Sous "Alarm sending" (envoyer email en cas de), vous pouvez configurer dans quels cas d'alarmes l'envoi d'un e-mail ou le transfert dans Mcloud doivent être immédiatement déclenchés.

Vérifiez les données du fournisseur d'accès et les adresses des destinataires en réalisant un test de fonctionnement (voir chap. 6.5). L'envoi d'un e-mail est alors tout de suite déclenché.

## 5.4.5 Formulaire "SMS"

Le X-zone Com peut être configuré de manière à ce qu'en cas d'alarmes il envoie des SMS aux numéros de téléphones définis par l'utilisateur. De plus, l'utilisateur a la possibilité d'interroger le statut en cours par SMS et d'envoyer des instructions au X-zone Com (voir chap. 7).

**REMARQUE**

Tous les paramétrages réalisés doivent être transférés une fois vers le X-zone Com en cliquant sur [Upload] (enregistrer).

The screenshot shows a web interface for configuring SMS. At the top, there are tabs for 'Device', 'Data Logger', 'GSM/GPRS', 'Email', 'SMS', and 'State'. The 'SMS' tab is active. On the left, there is a table with 'Phone No.' and three entries: '08150 1234432100', '08150 9876543210', and '04711 0815081500'. Below the table are 'Add' and 'Remove' buttons, and a 'Max. Alarms/day:' dropdown set to '99'. The 'Content' section has a 'Prefix:' field with 'Alarm' and two radio button options: 'Alarm type, Gas type, Value, Unit, X-zone ID' (selected) and 'Alarm type, Gas type'. The 'Alarm Sending' section has three checkboxes: 'A1' (checked), 'A2' (checked), and 'Device error' (checked). The 'PIN' section has 'Read:' set to '1234' and 'Execute:' set to '4321'.

Fig. 5.18: Paramètres pour l'envoi de SMS. Ici vous déterminez le contenu du SMS à envoyer en cas d'alarme. Tout à fait à droite vous attribuez le "Read"-PIN (PIN lecture) et le "Execute"-PIN (PIN exécuter).

Dans le formulaire „SMS“ il est possible de définir jusqu'à quatre destinataires SMS, qui seront informés en cas d'alarme. Pour en ajouter un, cliquez sur [Add] (ajouter) et saisissez le numéro. Avec [Remove] (supprimer) vous supprimez le numéro marqué. Si aucun numéro n'est attribué, la fonction SMS s'arrête. Il est en outre possible de définir le nombre maximum de SMS à envoyer par jour (1..99 SMS pro Tag). Pour cela, la case [Max. Alarms/day] (alarmes maxi/jour) doit être cochée. Si la case est désactivée, le nombre de messages SMS à envoyer est illimité.

**Contenu SMS :** Dans "Content" (contenu SMS), vous pouvez définir une suite de caractères comme préfixe (ne sont pas admis : „§“, „°“, les trémas allemands et le „ß“), qui vient après le nom de l'appareil dans chaque SMS d'alarme. D'autre part, vous pouvez choisir si la valeur mesurée actuelle et l'ID du X-zone 5x00 qui émet l'arme doit aussi être contenue dans le SMS d'alarme ou seulement le type d'alarme et le type de gaz.

**l'envoi d'alarme:** Dans "Alarm Sending" (envoyer SMS en cas de), vous déterminez dans quel cas d'alarme un SMS est envoyé.

Type d'alarme	Signification
<b>A1</b>	Pré-alarme de concentration <b>Particularité :</b> pour type de gaz O2 = manque d'oxygène
<b>A2</b>	Alarme de concentration principale <b>Particularité:</b> pour type de gaz O2 = excédent d'oxygène
<b>Défaut appareil</b>	Défaut appareil sur le X-am 5x00 ou le X-zone 5x00. L'appareil ou plusieurs canaux de détection ne sont pas opérationnels. Défauts appareils signalés du X-zone Com au chap. 10.1.

**REMARQUE**



Vérifiez la signification exacte des types d'alarme dans le mode d'emploi du X-am 5x00.

**PIN:** Pour les demandes par SMS, que le X-zone Com doit accepter comme valables, vous pouvez attribuer deux PINs. Ceux-ci doivent être compris dans le SMS au X-zone Com. Pour les actions de simple lecture, le "Read-PIN" (PIN lecture), et pour les actions de lecture et consécutives, qui influencent par ex. la situation actuelle, le "Execute-PIN" (PIN exécution) doivent être contenus dans le SMS. Le X-zone Com réagit exclusivement aux SMS avec un PIN correct et ignore tous les autres. Un descriptif détaillé du SMS possible figure au chap. 7.

Vérifiez les numéros de téléphone saisis en réalisant un test de fonctionnement (voir chap.6.5). Si un SMS doit être envoyé pour au moins un des trois cas d'alarme, l'envoi d'un SMS d'alarme est immédiatement déclenché lors du test.

Exemple de SMS d'alarme :

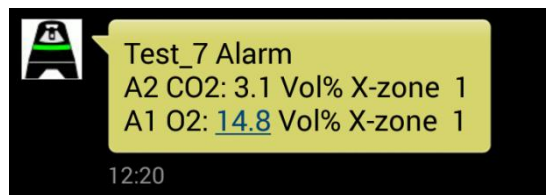



Fig. 5.19: Exemple de SMS d'alarme envoyé. Le X-zone Com "Test\_7" envoie une alarme A2 pour le CO2 et une alarme A1 pour l'oxygène, mesurés à partir de l'appareil groupé X-zone avec l'ID 1.

**REMARQUE**



Seul l'abonné SMS qui a envoyé la demande reçoit un SMS de réponse.

### 5.4.6 Formulaire "State"

Le formulaire „State“ (statut) affiche le statut actuel pour le matériel et les zones de fonctionnement du X-zone Com connecté. Une coche verte placée devant signale leur disponibilité.

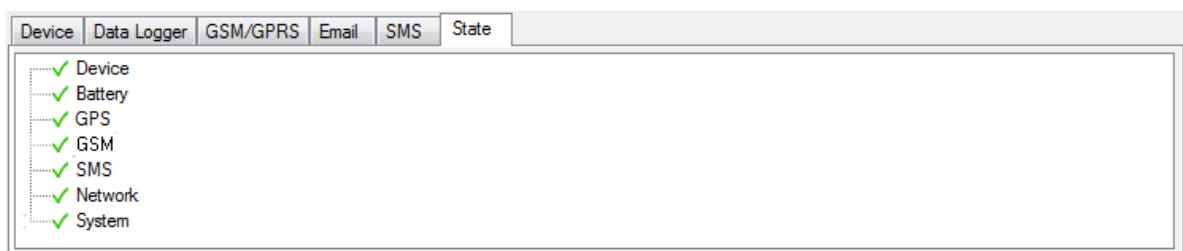

Fig. 5.20: Disponibilité intégrale du X-zone Com

En cas de défaut appareil ou de panne, ceci est signalé par une croix rouge. Un clic sur le signe plus placé alors devant dans l'arborescence ouvre un message détaillé.

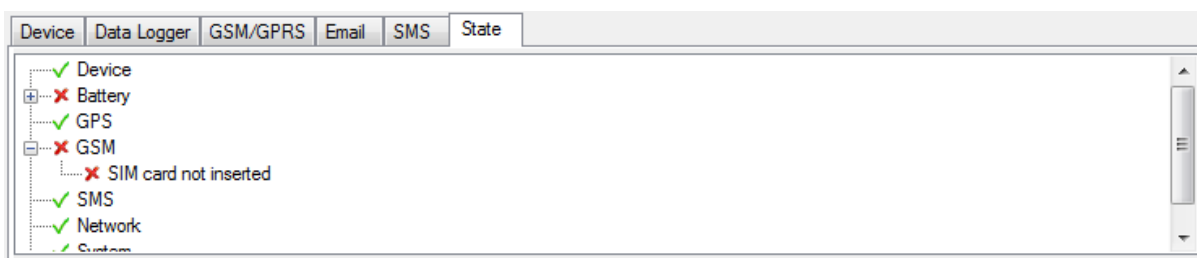

Fig. 5.21: Deux erreurs se sont produites.

## 5.5 PLAGE DE VALEURS MESURÉES

La plage de valeurs mesurées indique les valeurs mesurées et les alarmes en cours.

Aktuelle MAXIMALE Sensorwerte (das verbundene Gerät ist kein Master)				
X-zone ID	Gastyp	Wert	Einheit	Alarmtyp
0	O2	20,9	Vol%	A1
0	H2S	0	ppm	
0	CO	0	ppm	
0	CO2	0,25	Vol%	A2
0	ch4	0	%LEL	
1	ch4	0	%UEG	

Fig. 5.22: Valeurs mesurées et alarmes dans la plage de mesures du Manager Software. Les deux alarmes présentes ont été déclenchées par l'appareil collectif 0.

Le tableau indique pour chaque mesure le numéro d'identification du X-zone 5x00 dans le groupe, le type de gaz, la concentration actuelle en gaz et l'unité ainsi que le type d'alarme si une alarme est présente.

A partir du texte situé en haut du tableau, il est possible de retrouver si le X-zone 5x00 connecté fait partie d'un réseau ouvert ou fermé (groupe), et donc si une valeur mesurée est une valeur locale ou une valeur maximale provenant du groupe (voir chap. 4.2.4).

Intitulé	Signification
Valeurs détectées actuelles LOCALES ( pas de groupes fermés configurés)	<b>Réseau ouvert</b> : Les valeurs détectées du X-zone 5x500 rattaché localement au X-zone Com s'affichent.
Valeurs détectées actuelles MAXIMALES (l'appareil relié n'est pas un appareil principal)	<b>Groupe</b> : mesures maximales des types de gaz actuellement mesurés dans le réseau
Valeurs actuelles MAXIMALES du capteur	<b>Groupe</b> : Valeurs mesurées maximales des types de gaz actuellement mesurés dans le réseau
Non connecté au X-zone 5x00	Pas de liaison avec le X-zone

## 6 COMMANDE SUR LE X-ZONE COM

La commande du X-zone Com est expliquée ci-dessous.



### 6.1 PANNEAU DE COMMANDE

Le X-zone Com possède un écran OLED, sur lequel sont représentées les informations les plus importantes, et deux touches – gérables à l'aide du stylet magnétique.



Fig. 6.1: panneau de commande X-zone Com

Affectation des touches:

	Touche <b>ON/OFF</b> pour mettre en marche et arrêter l'appareil	<b>Maintien long</b> ON (env. 3 sec.) OFF (env. 3 sec)	<b>Appui bref :</b> retour à la vue d'ensemble
	Touche de <b>fonctionnement</b>	<b>Maintien long</b> Réaliser un test de fonctionnement	<b>Appui bref</b> Passer à l'écran suivant lorsqu'il y a des erreurs. Pendant un test de fonctionnement, l'appui bref achève le test.

### 6.2 MISE EN ROUTE DE L'APPAREIL

Pour mettre en marche le X-zone Com, activez le bouton gauche (ON/OFF) avec le stylet magnétique pendant env. 3 secondes. Pendant ce temps, l'écran affiche un compte à rebours à partir de 3.

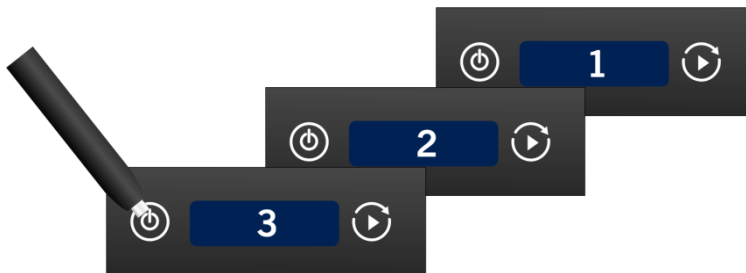

fig. 6.2: Compte à rebours à la mise en marche.

#### PRUDENCE



Le X-zone Com peut être exploité uniquement dans les plages de températures indiquées.

Lors de la mise en route, le X-zone Com essaie automatiquement de se connecter au réseau GSM et de calculer les coordonnées GPS. Avec une batterie vide, le X-zone Com ne peut pas se mettre en route.

S'il n'y a aucune carte SIM dans le modem, l'erreur x21 „no SIM card“ est générée.

## 6.3 ETEINDRE L'APPAREIL

Pour éteindre le X-zone Com, activez la touche de gauche (ON/OFF) avec le stylet magnétique pendant env. 3 secondes. Pendant ce temps, l'écran affiche un compte à rebours à partir de 3.

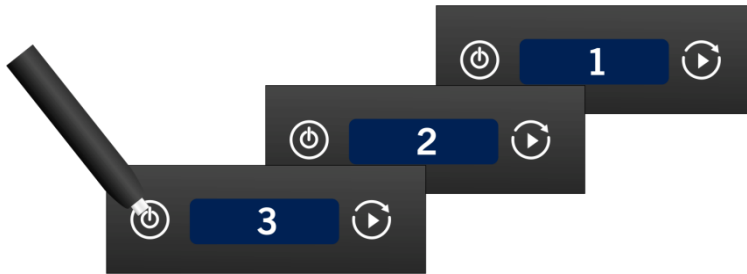

Fig. 6.3: Compte à rebours pendant l'arrêt.

En cas de batterie vide, le X-zone Com s'arrête automatiquement.

## 6.4 AFFICHAGES ÉCRAN

L'affichage écran est réparti en deux zones.



- Zone de gauche : affichage statut pour les différentes fonctions ou actions.
- Zone de droite : affichage statut global.



Fig. 6.4: affichage sur X-zone Com.











### 6.4.1 Tableau des symboles

Le statut global est décrit à travers les symboles suivants.

Symbole	Signification	Symbole	Signification
	Aucun défaut présent actuellement. Toutes les actions du test de fonctionnement se sont achevées avec succès.		Etat de la dernière action : un défaut appareil X-zone Com s'est produit.
	Au moins une action en cours (par ex. établissement d'une connexion, envoi de SMS, calcul de position).		

Les significations des symboles pour les différentes fonctions sont expliquées dans le tableau suivant.

Symbole	Signification	Symbole	Signification
	Transmission de données vers ORI Mcloud activée !		

	<b>Clignotant</b> : données en cours d'envoi.		
	Envoi e-mail à au moins un destinataire activé. <b>Clignotant</b> : e-mail en cours d'envoi.		Envoi e-mail et transfert dans Mcloud impossibles/ interrompus.
	SMS envoyé/activé avec succès. <b>Clignotant</b> : SMS en cours d'envoi.		Le SMS n'a pas pu être envoyé.
	Batterie entièrement chargée <b>Chargement batterie à cycle croissant sur l'écran</b> : batterie en charge		Batterie vide – l'appareil peut s'éteindre à tout moment
	Position GPS calculée avec succès. <b>Clignotant</b> : recherche des coordonnées		Aucun GPS (déconnecté ou réception impossible)
	Force du signal env. 100 %		
	Force du signal env. 20 % <b>Clignotant</b> : connexion dans le réseau GSM actuellement active.		Aucune connexion avec le réseau GSM

**Exemple :**

1.		La batterie est encore chargée à env. 75 %, la force du signal est d'env. 100 %, la connexion vers Mcloud et les fonctions e-mail sont activées, les coordonnées GPS ont été trouvées. L'état général est OK.
----	---	---



### 6.4.2 Affichages erreurs

Différentes erreurs peuvent s'afficher à l'écran. Un tableau des erreurs se trouve au chap. 10.1. Il contient un descriptif pour chaque erreur et une action recommandée. Avec le bouton droit, il est possible de passer d'un affichage d'erreur à l'autre.



Fig. 6.5: exemple d'erreur survenue avec numéro d'erreur et bref descriptif

**Exemples :**

	SMS et e-mail n'ont pas été envoyés lors du test de fonctionnement. L'envoi de données dans Mcloud n'est pas activé dans cet exemple.
	<b>Origines possibles :</b>
	<ul style="list-style-type: none"> <li>• Numéro de téléphone non valide</li> <li>• Adresse e-mail erronée pour "to" et "copy to"</li> </ul>

## 6.5 RÉALISIER UN TEST DE FONCTIONNEMENT

Le test de fonctionnement sert à vérifier les paramètres d'envoi et de réception et le bon fonctionnement du X-zone Com ainsi que la réception GSM et GPS. D'autre part, il lance automatiquement un calcul de position.

Le test de fonctionnement est déclenché en activant la touche de commande de droite  (3 sec.) du X-zone Com. Les actions suivantes sont alors exécutées :

- Activer le GPS, rechercher les coordonnées et l'heure.
- Connecter le modem au réseau radio, réaliser l'accès APN, rechercher l'adresse IP.
- Envoi d'e-mails aux destinataires inscrits avec toutes les données non encore envoyées
- Transférer toutes les données non encore envoyées dans Mcloud, dans la mesure où la fonction Mcloud est activée
- Envoi d'un SMS à tous les numéros de téléphone inscrits, dans la mesure où un SMS doit être envoyé pour au moins un cas d'alarme.

Les informations sur le statut s'affichent à l'écran (envoi de SMS, e-mail et Cloud, calcul de positionnement). Tant qu'une action n'est pas terminée, le symbole clignote.

Si des erreurs surviennent, le symbole d'erreur correspondant s'affiche automatiquement dans la zone droite de l'écran. Des informations complémentaires sur les erreurs peuvent être consultées dans le Manager Software dans le formulaire "State" (chap.5.4.6).



Si des SMS et e-mails ont été envoyés et la position calculée avec succès, l'écran représenté à gauche apparaît.

En activant le bouton de gauche, l'affichage passe à nouveau à l'écran statut.

### REMARQUE



*Pendant le test de fonctionnement, la touche de commande de gauche du X-zone Com est limitée. Seul un arrêt de l'appareil est possible.*



## 7 SMS AU X-ZONE COM

Le X-zone Com offre à l'utilisateur la possibilité d'interroger par SMS le statut actuel et d'envoyer des instructions au X-zone Com. Pour une demande par SMS, vous devez utiliser la structure suivante.

[PIN] Commandement

Le [PIN] (personal identification number) à saisir est le es "Read-PIN" (PIN de lecture) que vous avez attribué dans le Manager Software pour les actions de simple lecture ou bien le "Execute-PIN" (PIN d'exécution) pour les actions consécutives influençant par ex. la situation en cours (voir chap.5.4.5). Le PIN empêche que des SMS de personnes non autorisées soient acceptés par le X-zone Com.

Une mauvaise saisie du PIN génère un message d'erreur directement sur l'appareil. Une réponse SMS n'a pas lieu dans ce cas.



Fig. 7.1: Message d'erreur sur l'appareil lors de l'utilisation du mauvais PIN SMS.

La commande peut s'écrire en minuscules ou en majuscules. Un point d'interrogation rattaché à la commande est permis.

Les réponses SMS sont décrites en détail dans les sections suivantes.

PIN	Commande	Réponse
<b>[PIN de lecture]</b>	Stat	Informations appareil
	Group	Information groupe
	Local	Mesures locales du X-zone 5x00 directement relié au X-zone Com
	Max	Mesures maximales des gaz mesurés dans le réseau fermé
	Alarm	Valeurs d'alarme actuelles
<b>[PIN d'exécution]</b>	Ack	Acquittement alarme
	Evac	Alarme évacuation marche
	Evac off	Alarme évacuation arrêt
	GPS	Dernières coordonnées GPS connues

## 7.1 ORDRES SMS DE LECTURE

Les ordres SMS de lecture peuvent être transmis avec le "Read-PIN" ou avec le "Execute-PIN".

### 7.1.1 Consultation du statut

#### [PIN] stat

Contenu du SMS de réponse	Plage de valeurs
Nom appareil du X-zone Com	Suite de caractères ASCII définie par l'utilisateur
Statut de connexion au X-zone 5x00	"X-zone connected" "X-zone not connected"
GSM RSSI level [-dBm]	-100 bis 0
Tension batterie X-zone Com [V]	12 bis 13,5 V (15V maximum)
Tension batterie X-zone 5x00 [V]	5 bis 7 V
Utilisation d'e-mails d'alarme	ON/OFF
Intervalle paramétré pour l'envoi d'e-mails et la transmission de données dans Mcloud	5/10/15/30 minutes; 1/2/3/4/6/8/12 heures;. 1 jour

#### Exemple :

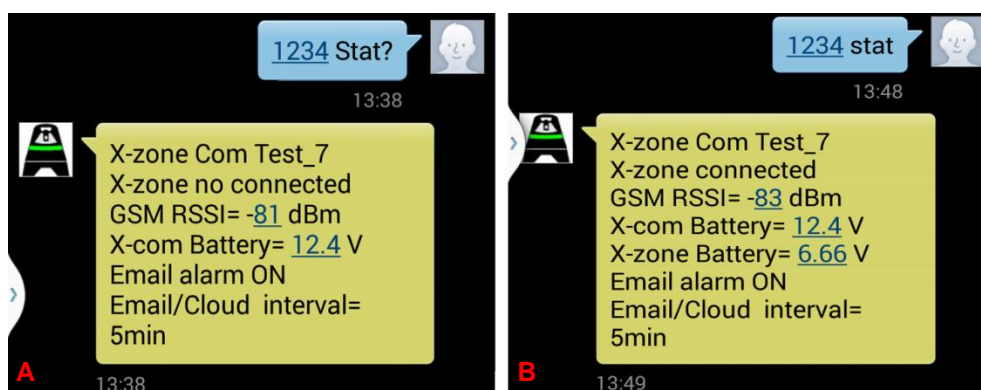

Fig. 7.2: Ecran d'un Smartphone après consultation du statut par SMS.

A) Réponse pour une connexion erronée vers le X-zone 5x00.

B) Réponse pour une connexion existante vers le X-zone 5x00.

Différentes écritures possibles pour la commande.

## 7.1.2 Consultation des informations concernant le statut du groupe

Avec la commande "group" (groupe), les informations sur le groupe d'appareils ou d'un appareil non groupé peuvent être consultées dans un réseau ouvert.

### [PIN] group

Contenu du SMS de réponse	Plage de valeurs
Nom appareil du X-zone Com	Suite de caractères ASCII définie par l'utilisateur
Statut de groupe de l'appareil	„Main device“ „Group device“ „ungrouped“
Taille du groupe si raccordé à l'appareil principal	2 bis 15
Etat de l'alarme	No alarm, A1, A2, device error
Nombre de gaz surveillés (du groupe ou du X-zone 5x00 relié localement)	0 à 8

### Exemple: Réponse pour un groupe

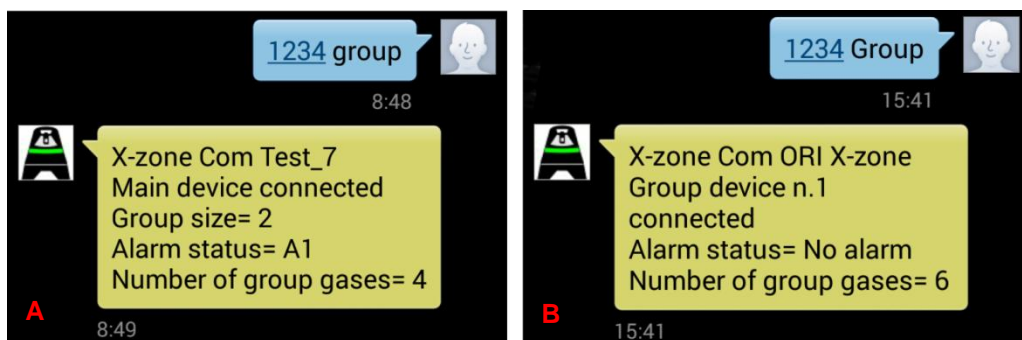

Fig. 7.3: Ecran d'un Smartphone après consultation d'un statut de groupe.

**A)** L'appareil qui répond est l'appareil principal (ID=0). Le groupe se compose de 2 appareils et surveille 4 gaz en tout. Une alarme A1 est présente.

**B)** Le X-zone Com est raccordé à l'appareil groupé avec l'ID 1. 6 gaz en tout sont surveillés par le groupe. Aucune alarme n'est présente.

**Exemple:** Réponse d'un appareil local

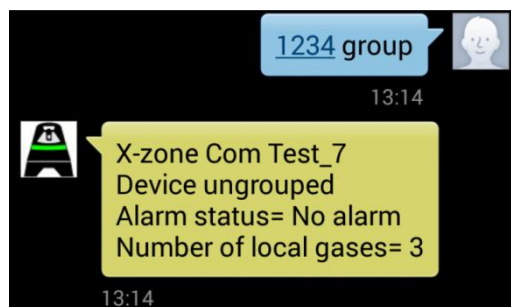

Fig. 7.4: L'appareil répondant est un appareil local non groupé qui surveille 3 gaz en tout.

### 7.1.3 Valeurs mesurées du X-zone 5x00 raccordé localement

Lors de la demande SMS "Local", les valeurs mesurées actuelles du X-zone 5x00 relié directement au X-zone Com sont transmises, que celui-ci fasse partie d'un groupe ou non.

#### [PIN] local

Contenu du SMS de réponse	Plage de valeurs
Nom appareil du X-zone Com	Suite de caractères ASCII définie par l'utilisateur
Type de gaz	Nom abrégé du gaz du X-am 5x00
Valeur de concentration	0 à 10.000
Unité	Vol%, %UEG, %LEL, %LIE, ppm, mg/m3, ppb, mbar, hPa, kPa, mg/L
Type d'alarme	A1, A2
Numéro d'identification	Numéro de série du X-zone 5x00

**Exemple :**

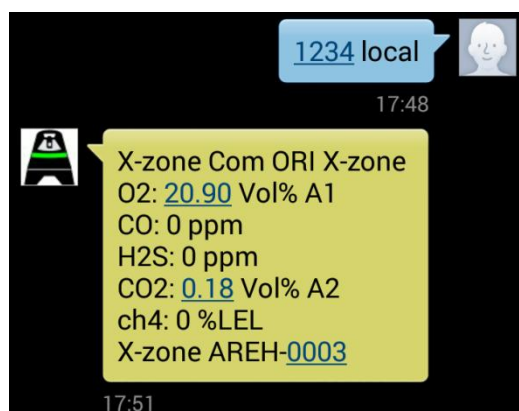

Fig. 7.5: Ecran d'un Smartphone après envoi de "1234 local". Dans l'exemple, le X-zone "AREH-0003" relié au X-zone Com "ORI X-zone" mesure 5 gaz. Pour le CO<sub>2</sub> il y a une alarme A2 et pour O<sub>2</sub> une alarme A1.

## 7.1.4 Consultations des valeurs mesurées maximales dans un groupe

Le X-zone Com transmet une liste qui contient la valeur maximale mesurée actuelle pour chaque gaz mesuré par le groupe, y compris un éventuel type d'alarme présent et l'ID appareil. Pour l'oxygène, la valeur affichée correspond à la valeur minimale.

### [PIN] max

Contenu du SMS de réponse	Plage de valeurs
Nom appareil du X-zone Com	Suite de caractères ASCII définie par l'utilisateur
Type de gaz	Nom abrégé du gaz du X-am 5x00
Valeur de concentration	0 à 10.000
Unité	Vol%, %UEG, %LEL, %LIE, ppm, mg/m3, ppb, mbar, hPa, kPa, mg/L
Type d'alarme	A1, A2
Numéro d'identification du X-zone 5x00 dans le groupe qui a mesuré la valeur maximale	0 à 15

**Exezmple:** Valeurs maximales

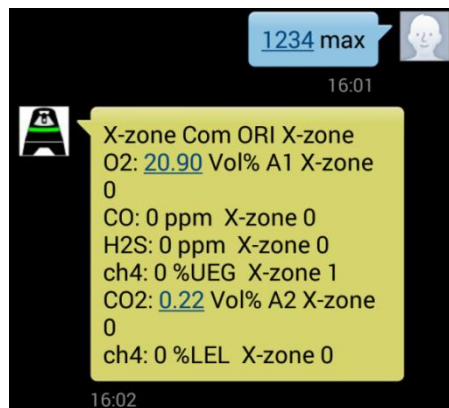

Fig. 7.6: Ecran d'un Smartphone après consultation des valeurs maximales de tous les gaz surveillés par le groupe. Dans l'exemple, la valeur ch4 de l'appareil groupé est mesurée avec ID=1. Les autres gaz de l'appareil principal avec ID=0. Pour O<sub>2</sub> et CO<sub>2</sub> il y a une alarme A1 respectivement A2.

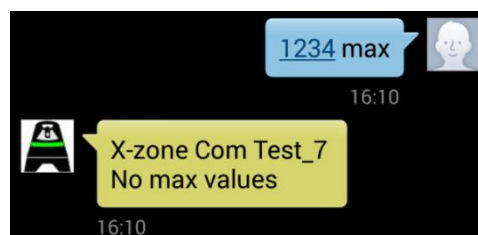

Fig. 7.7: Ecran d'un Smartphone, dans le cas où le X-zone 5x00 raccordé n'est pas un appareil groupé. Utilisez dans ce cas la commande "local".

## 7.1.5 Afficher les coordonnées GPS

Le SMS de réponse contient la dernière position connue du X-zone Com.

### [PIN] GPS

Contenu de la réponse SMS	Plage de valeurs
Nom appareil du X-zone Com	Suite de caractères ASCII définie par l'utilisateur
Coordonnées	Latitude, longitude
Hauteur	Hauteur approximative au-dessus du niveau de la mer (Mean Sea Level)
Date et heure du dernier calcul de position abouti	Date et heure

L'heure affichée se compose de "Universal Time Coordinated [UTC]" et du décalage horaire local, par ex. en Europe centrale :

- Normal : UTC+1
- Heure d'été : UTC+2

Exemple :

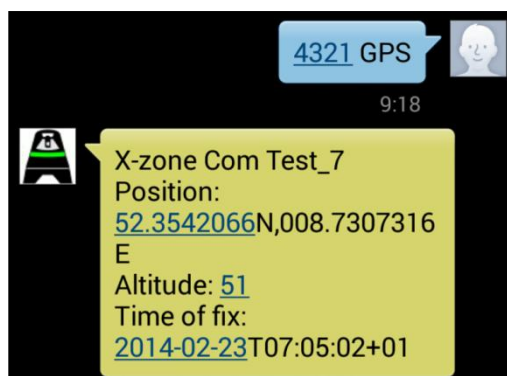

Fig. 7.8: Ecran d'un Smartphone après consultation de la position. Dans l'exemple, les coordonnées ont été calculées pour la dernière fois à 08:05 heure locale (UTC+1). L'interrogation par SMS a eu lieu à 09:18 heure locale.

## 7.1.6 Consultation des alarmes en cours

Une liste des alarmes en cours est envoyée. Celle-ci peut contenir les alarmes gaz et les défauts appareils. Pour une alarme gaz, les données transmises sont : le type de gaz ayant déclenché l'alarme, la valeur mesurée actuelle et son unité et sur quel X-zone 5x00 l'alarme se produit. Pour les défauts appareils, l'information porte sur le X-zone 5x00 sur lequel le défaut se produit mais sans code défaut.

La structure de la réponse SMS dépend de vos paramétrages dans le Manager Software.

Fig. 7.9: Définition de la structure de la réponse SMS dans le Manager Software.

### [PIN] Alarme

#### En cas d'alarme gaz (A1, A2)

Contenu de la réponse SMS	Plage de valeurs
Nom de l'appareil de X-zone Com	Chaîne de caractères ASCII définie par l'utilisateur
Préfixe	Chaîne de caractères ASCII définie par l'utilisateur
Type d'alarme	A1, A2
Type de gaz	Noms abrégés du gaz du X-am 5x00
Valeur de concentration (optionnel)	0 à 10.000
Unité (optionnel)	Vol%, %UEG, %LEL, %LIE, ppm, mg/m3, ppb, mbar, hPa, kPa, mg/L
ID du X-zone 5x00 (optionnel)	0 à 15 ou numéro de série du X-zone 5x00

#### En cas de défaut appareil d'un X-zone 5x00

Contenu de la réponse SMS	Plage de valeurs
Nom de l'appareil de X-zone Com	Chaîne de caractères ASCII définie par l'utilisateur
Préfixe	Chaîne de caractères ASCII définie par l'utilisateur

Type d'alarme	"Device alarm"
ID du X-zone 5x00 (optionnel)	0 à 15 ou numéro de série du X-zone 5x00

### Exemples: Alarmes



Fig. 7.10: Ecran d'un Smartphone après une demande d'alarme. La demande portait sur le X-zone Com "Test\_7". Il y a une alarme A1 au niveau de l'oxygène. La valeur d'oxygène suivante porte sur la valeur O2 actuellement mesurée et non pas sur celle ayant entraîné l'alarme.

L'alarme a été déclenché

- A. par le "X-zone 0" (0=appareil principal)
- B. par le "X-zone 1" (1=appareil groupé).

#### REMARQUE



Dans le cas d'une alarme actionnée au préalable, vous recevez lors de l'envoi de la commande PIN Alarm le message "All alarms stopped".



## 7.2 COMMANDES SMS D'EXECUTION

### REMARQUE



Pour les commandes SMS d'exécution, vous avez besoin du "Admin-PIN" défini dans le Manager Software.

### 7.2.1 Acquittement alarme

Le comportement du X-am 5x00 lors de l'acquittement d'une alarme dépend de sa configuration. Les alarmes peuvent être acquittées ou non acquittées et autosuffisantes ou non autosuffisantes. Veuillez donc lire attentivement le mode d'emploi de votre appareil de mesure du gaz Dräger X-am 5x00.

### REMARQUE



L'acquittement de toutes les alarmes n'implique pas forcément que plus aucune alarme n'est signalée. Le comportement du système dépend de la situation de l'alarme et de la configuration du X-am 5x00.

La réponse SMS contient en plus du nom d'appareil de l'X-zone Com un texte de confirmation comme quoi les alarmes ont été acquittées.

#### [PIN d'exécution] ack

Contenu de la réponse SMS	Plage de valeurs
Nom appareil du X-zone Com	Suite de caractères ASCII définie par l'utilisateur
Texte de confirmation	"Alarms acknowledged"

#### Exemple:

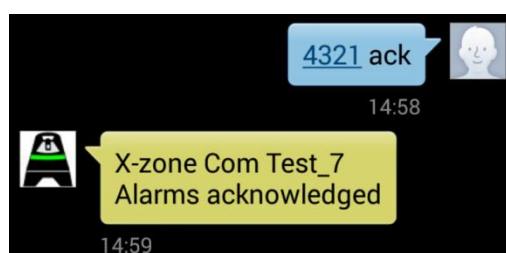

Fig. 7.11: Ecran d'un Smartphone après envoi de l'acquittement de l'alarme.

### 7.2.2 Activer l'alarme d'évacuation

L'utilisateur peut par un SMS déclencher une alarme qui est signalée par le réseau X-zone 5x00 en tant qu'alarme A2. Celle-ci est appelée alarme d'évacuation car elle sert habituellement à faire évacuer un secteur.

## [PIN d'exécution] evac

Contenu de la réponse SMS	Plage de valeurs
Nom appareil du X-zone Com	Suite de caractères ASCII définie par l'utilisateur
Texte de confirmation	"Evacuation alarm"

Exemple:

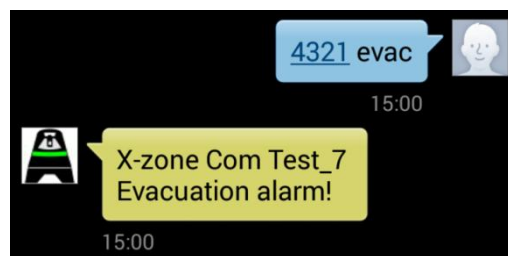

Fig. 7.12: Ecran d'un Smartphone après le déclenchement d'une alarme d'évacuation.

### REMARQUE



Lors d'une alarme d'évacuation, le symbole d'évacuation apparaît sur l'écran de tous les X-am 5x00 dans le groupe.

## 7.2.3 Mettre fin à l'alarme d'évacuation

Il peut être mis fin à l'alarme d'évacuation par SMS ou en déconnectant le X-zone Com.

## [PIN d'exécution] evac off

Contenu de la réponse SMS	Plage de valeurs
Nom appareil du X-zone Com	Suite de caractères ASCII définie par l'utilisateur
Texte de confirmation	"Evacuation alarm stopped"

Exemple:

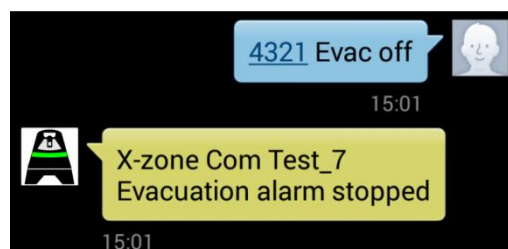

Fig. 7.13: Ecran d'un Smartphone après remise à zéro de l'alarme.

## 8 BREF APERÇU DU MCLLOUD

La fonctionnalité du Mcloud ORI et son utilisation sont brièvement expliquées dans ce chapitre. Vous trouverez des informations détaillées sur le Mcloud ORI dans le manuel qui s'y rattache.

Le Mcloud est un portail de données Internet depuis lequel vous pouvez consulter et visualiser les données de votre X-zone Com à l'aide d'un moteur de recherche Internet. En plus du statut général de l'appareil, du niveau de la batterie et de l'instant du dernier envoi, vous y trouverez toutes les courbes des valeurs mesurées et les valeurs d'alarme. Il est possible de sélectionner la période pour les séries de mesures. Vous pouvez exporter les données représentées graphiquement dans un fichier CSV et les télécharger sur votre PC, là où les données peuvent s'ouvrir et se traiter par exemple avec Microsoft Excel. De plus, vous pouvez faire s'afficher la position de vos appareils X-zone Com sur une carte.

Pour l'accès au Mcloud, vous avez besoin d'un accès Internet, d'un moteur de recherche Internet et – au bout de 4 semaines – d'une licence par appareil. Les quatre semaines gratuites pour vous commencent dès que vous avez enregistré l'appareil. Une fois cette durée écoulée, vous pouvez acquérir des licences à durée limitée. Si la licence d'un X-zone Com est valable, vous pouvez stocker autant de valeurs mesurées que vous voulez. Avant l'expiration d'une licence, vous êtes prévenu en temps utile par un symbole d'avertissement au sein de la liste des appareils.

Les données de votre X-zone Com sont stockées en Allemagne sur un serveur vérifié par le TÜV conformément au "Trusted Site TSI V3.0 Level 1". L'accès via un moteur de recherche est protégé par un mot de passe et s'effectue par le biais d'un protocole de transfert hypertexte HTTPS.

### 8.1 LISTE DES APPAREILS MCLLOUD

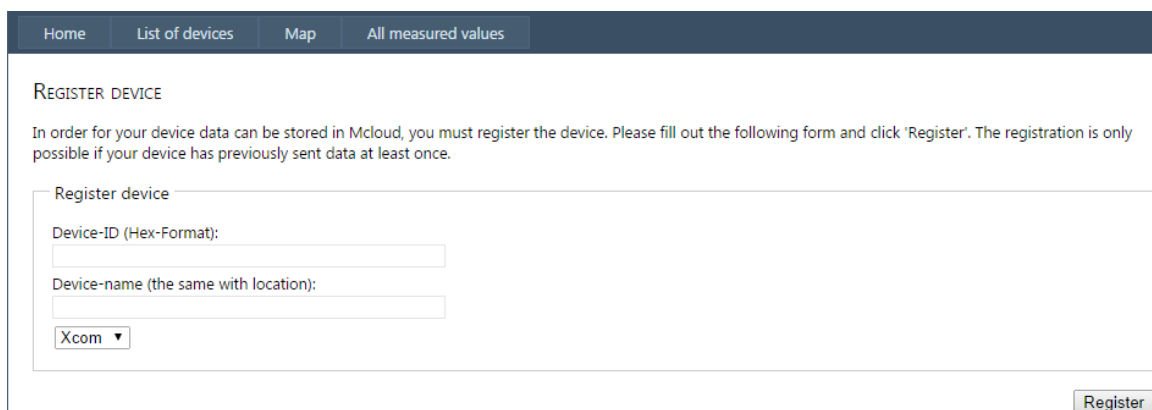

Tous vos appareils enregistrés sont affichés dans la liste des appareils. Si votre appareil n'est pas affiché, c'est qu'il doit être encore enregistré dans le Mcloud (voir Fig. 8.2). Un enregistrement n'est possible que si votre appareil a émis au moins une fois avant. Pour transférer les données mesurées au Mcloud, vous devez donc penser à activer la fonctionnalité Cloud à l'aide du Manager Software (voir chap. 5.4.4).



The screenshot shows a web interface for registering a device. At the top, there is a navigation bar with four tabs: 'Home', 'List of devices', 'Map', and 'All measured values'. Below the navigation bar, the page title is 'REGISTER DEVICE'. A paragraph of text explains that the device must be registered for its data to be stored in Mcloud, and that registration is only possible if the device has previously sent data at least once. Below this text is a registration form with three input fields: 'Device-ID (Hex-Format):', 'Device-name (the same with location):', and a dropdown menu currently set to 'Xcom'. A 'Register' button is located at the bottom right of the form.







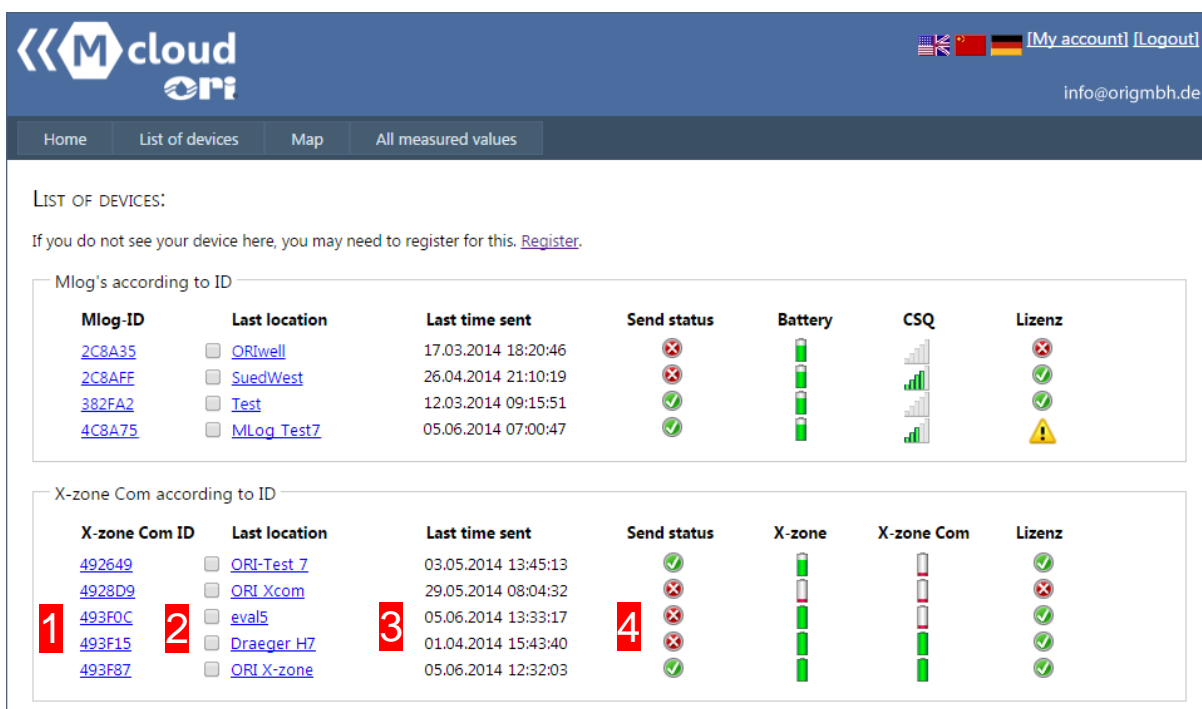









Fig. 8.1: Demande d'enregistrement du Mcloud d'ORI.

Pour chaque X-zone Com enregistré, vous voyez :

- **1** l'ID appareil
- **2** le dernier lieu de mesure (nom de l'appareil attribué par l'utilisateur à l'aide du Manager Software)
- **3** quand l'appareil a émis pour la dernière fois
- **4** Statu d'envoi  = actuellement actif;  = inactif sur une période assez longue (à partir de 24 heures)



The screenshot shows the Mcloud ORI web interface. At the top, there are navigation tabs: Home, List of devices, Map, and All measured values. The main content area is titled 'LIST OF DEVICES:' and includes a link to 'Register' if a device is not visible. There are two tables:

Mlog-ID	Last location	Last time sent	Send status	Battery	CSQ	Lizenz
<a href="#">2C8A35</a>	<input type="checkbox"/> ORIwell	17.03.2014 18:20:46				
<a href="#">2C8AFF</a>	<input type="checkbox"/> SuedWest	26.04.2014 21:10:19				
<a href="#">382FA2</a>	<input type="checkbox"/> Test	12.03.2014 09:15:51				
<a href="#">4C8A75</a>	<input type="checkbox"/> MLog_Test7	05.06.2014 07:00:47				



































X-zone Com ID	Last location	Last time sent	Send status	X-zone	X-zone Com	Lizenz
<a href="#">492649</a>	<input type="checkbox"/> ORI-Test 7	03.05.2014 13:45:13				
<a href="#">4928D9</a>	<input type="checkbox"/> ORI Xcom	29.05.2014 08:04:32				
<b>1</b> <a href="#">493F0C</a>	<b>2</b> <input type="checkbox"/> eval5	<b>3</b> 05.06.2014 13:33:17	<b>4</b> 			
<a href="#">493F15</a>	<input type="checkbox"/> Draeger H7	01.04.2014 15:43:40				
<a href="#">493F87</a>	<input type="checkbox"/> ORI X-zone	05.06.2014 12:32:03				

Fig. 8.2: Liste de tous les appareils enregistrés ainsi que le lien vers l'enregistrement des appareils.

Dans les autres colonnes figurent les informations complémentaires spécifiques à l'appareil, représentées par des symboles. Pour un X-zone Com par ex. la capacité propre de la batterie et la capacité de la batterie du X-zone 5x00 directement relié.

Capacité batterie (%)	CSQ (%) Force du signal	Statut de la licence
 env. 75-100%	 env.100%	 Licence valide
 env. 50-75%	 env.80%	 La licence expire prochainement
 env. 30-50%	 env.60%	 La licence a expiré
 env.15-30%	 env.40%	
 < 15%	 env. 20%	
	 aucun signal	

## 8.2 STATUT APPAREIL MCLLOUD

En cliquant sur l'ID appareil (1), vous faites s'afficher des informations détaillées sur l'appareil. C'est là qu'il est possible d'activer, par sécurité, la surveillance de l'intervalle d'envoi de l'appareil. Pour cela, saisissez dans "Monitoring time transmission interval" (durée surveillance intervalle d'envoi) le cycle d'envoi affecté dans le Manager Software (en minutes). Il est alors vérifié si le Cloud réceptionne des envois de l'appareil dans ces intervalles. Si ce n'est pas le cas, une alarme d'intervalle d'envoi est déclenchée.

**X-ZONE COM**

Here you can see the current status and parameter values of the last episode of your X-zone Com. In addition, you can also renew the license of your X-zone here.

**ORI X-zone**

X-zone Com location: ORI X-zone	Created on: 07.04.2014 18:20:14	Last measured value: 05.06.2014 12:31:58	Alarm X-zone: Ok	Battery X-zone: 6,609
X-zone Com ID: 493F87 (4800391)	Last time sent: 05.06.2014 12:32:03	Local timezone: 02:00:00	Alarm Net: Ok	Battery X-zone Com: 14,136

**GPS**

Time: 20/05/2014 17:31:34	Time zone: 02:00:00	Longitude: 8.730717	Latitude: 52.35361	Altitude: 0
------------------------------	------------------------	------------------------	-----------------------	----------------

**Parameter**

Monitoring time transmission interval [min]:  Enter 0 to switch off the monitoring. Acknowledge alarm Accept

**Licence**

X-zone Com license expiration date:  New Licence number:  License

Fig. 8.3: Indique le statut appareil en cliquant sur l'ID appareil. Au moment de la transmission, c'était l'heure d'été en Allemagne, c'est pourquoi c'est le fuseau horaire 02:00:00 qui s'affiche (UTC+2 – voir chap. 7.1.5).

Dans le cas d'une alarme d'intervalle d'envoi, vous êtes alerté par un e-mail et la couleur du symbole de l'appareil passe au rouge. Si l'alarme est acquittée, ce symbole sur la carte passe du rouge au vert. Vous pouvez passer dans la vue cartographique en cliquant sur le menu [Karte] dans la barre de menus principale.

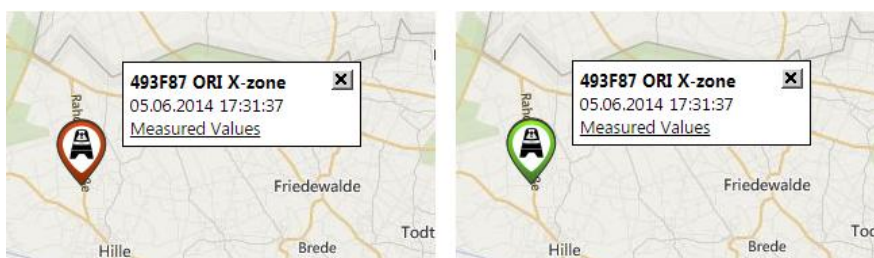

Fig. 8.4: Changement de couleur du symbole appareil sur la carte, qui passe du rouge au vert une fois l'alarme d'intervalle d'envoi acquittée.

## 8.3 VALEURS MESUREES MCLLOUD

En cliquant sur le dernier lieu de mesure (2) vous accédez aux mesures actuelles de l'appareil. C'est ici qu'il est possible de sélectionner les différents capteurs de mesure existants et d'afficher ensuite graphiquement leurs valeurs mesurées pour une période sélectionnée ou de les exporter en tant que fichier CSV.

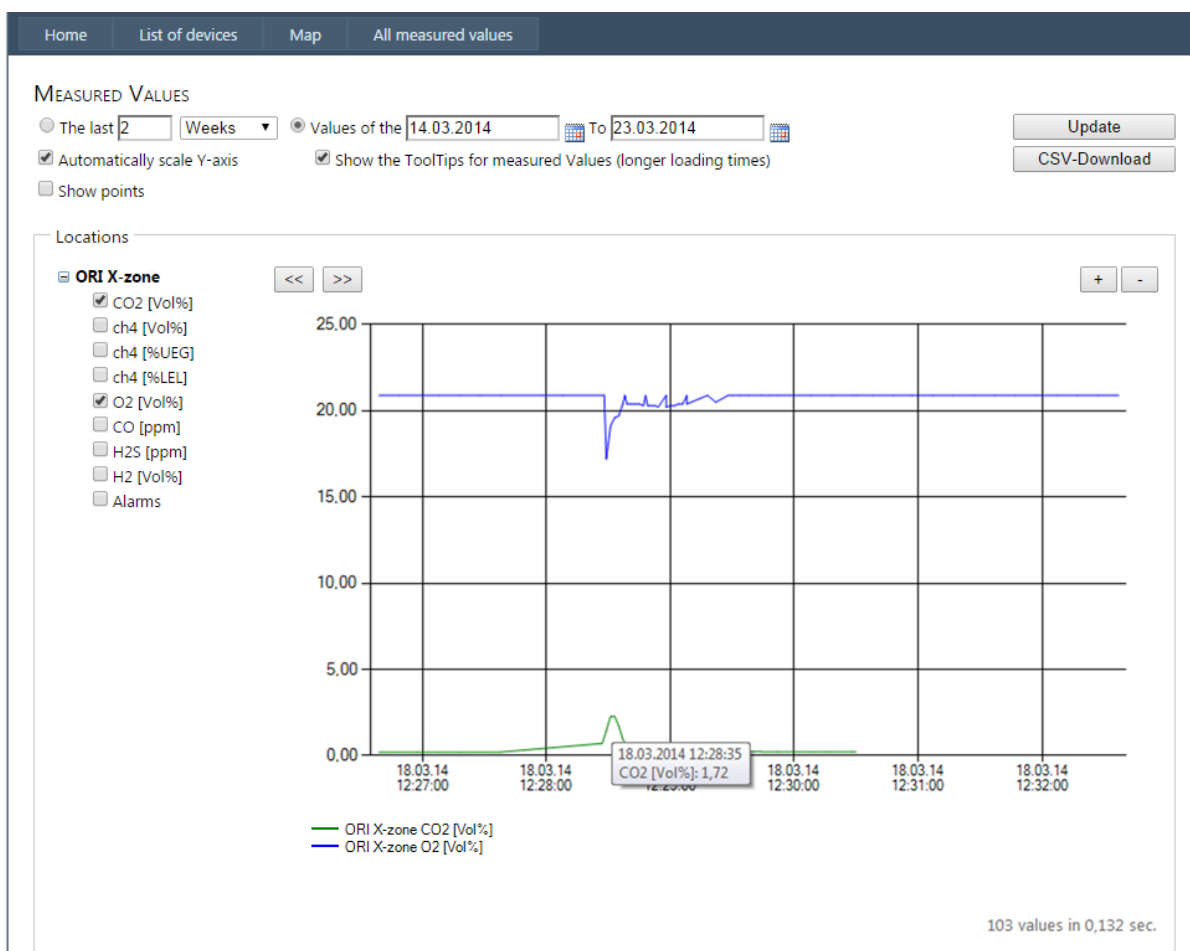

Fig. 8.5: Représentation graphique zoomée des mesures de deux détecteurs de gaz du X-zone Com Test\_7.

Les séries de données de plusieurs appareils peuvent être affichées en cochant les cases correspondantes des lieux de mesure. OU bien, cliquez sur [Alle Messwerte] (toutes les valeurs mesurées) dans la barre de menus pour afficher tous les appareils pouvant être sélectionnés, avec les capteurs associés.

### REMARQUE



Il est possible de représenter graphiquement ou d'exporter plusieurs suites de données d'appareils avec un ID différent. De plus, il est également possible d'afficher différents lieux de mesure d'un appareil avec différents capteurs.



## 8.4 REPRESENTATION CARTOGRAPHIQUE

En cliquant sur [Karte] (carte) dans la barre de menus principale, la position de tous les appareils enregistrés s'affiche sur la carte (affichage au choix entre vue cartographique, vue du ciel ou automatique).

Symboles appareils affichés	
	X-zone Com
	Caméra
	Mlog
	Dispositif d'échantillonnage

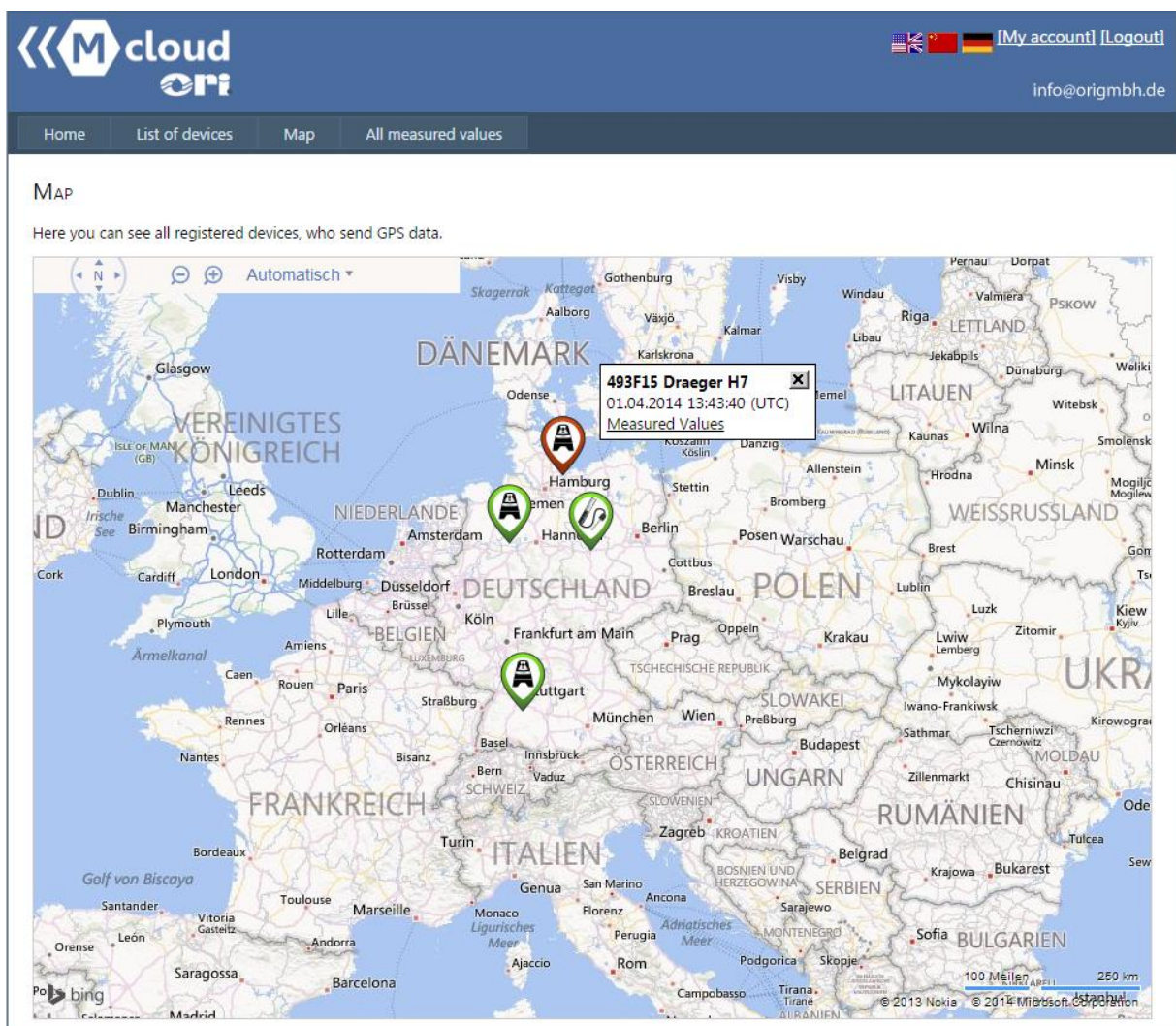

Fig. 8.6: Tous les appareils enregistrés s'affichent sur la carte.

En passant sur un symbole appareil avec le curseur de la souris, une petite fenêtre apparaît à droite du symbole, avec l'ID appareil, le nom de l'appareil, l'heure du dernier transfert de données et un lien vers les valeurs mesurées.

Avec la molette de la souris ou la loupe en haut à gauche, vous pouvez rentrer dans la carte ou en sortir.

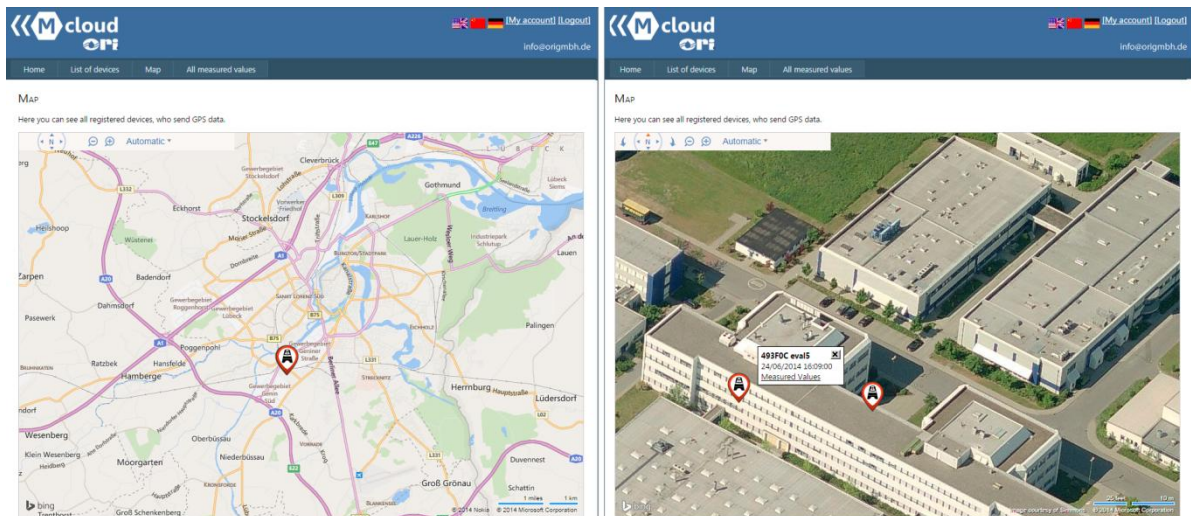

Fig. 8.7: Position des appareils enregistrés dans la représentation cartographique. En zoomant davantage, on passe automatiquement en vue du ciel. Des 2 appareils reconnaissables, l'un d'entre eux n'a plus envoyé de données au Mcloud depuis un certain temps (symbole appareil rouge).



## 9 ENTRETIEN ET MAINTENANCE

### 9.1 INTERVALLE

**X-zone Com:** L'appareil doit être régulièrement soumis à des inspections et des entretiens par des spécialistes.

**Chargeur :** Le chargeur ne nécessite aucun entretien spécial. Un SAV éventuel se fait par le fabricant ou des personnes agréées par lui.

### 9.2 NETTOYAGE

Nettoyer l'appareil uniquement avec un chiffon humide.

#### REMARQUE



**Pour le nettoyage, ne pas utiliser de produit contenant de l'alcool**

### 9.3 CHANGEMENT DE LA BATTERIE EN CAS DE RÉPARATION

#### AVERTISSEMENT



**Risque d'explosion !** ne pas ouvrir le compartiment batterie au sein d'une atmosphère ATEX. La batterie fait partie de l'homologation ATEX et le branchement et débranchement de la tension d'alimentation ne peuvent être réalisés que dans un environnement non exposé aux risques d'explosion.

#### PRUDENCE



**Domage sur l'appareil !** En ouvrant le boîtier, bien tenir la partie supérieure du X-zone Com, pour que celui-ci et la pile ne tombent pas et s'abîment.

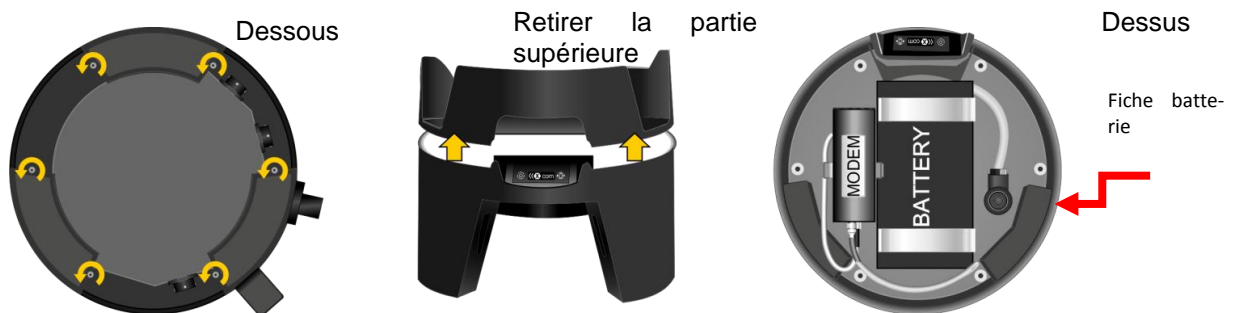

Fig. 9.1: Ouverture du compartiment batterie.

Défaire les 6 vis du boîtier sur la partie inférieure.

Retirer la partie supérieure

Retirer la fiche batterie, défaire l'étrier de retenue, retirer la batterie.

L'assemblage du X-zone Com se fait dans le sens inverse. Pour cela, serrez les vis à la main.

# 10 ANNEXE

## 10.1 CODES D'ERREURS

Code erreur	Affichage écran (X-zone Com)	Description	Aide
<b>Erreurs appareil</b>			
1	Check sum error	Erreur de test mémoire - Mémoire de configuration	Contactez le SAV ORI.
2	Check sum error	Erreur de test mémoire – Mémoire de données	Contactez le SAV ORI.
3	Internal HW error	<i>Real time clock</i> ne fonctionne pas	Contactez le SAV ORI.
6	Internal HW error	<i>RS485 bridge</i> ne fonctionne pas	Contactez le SAV ORI.
<b>Défauts batterie</b>			
9	Battery HW error	Erreur de communication avec le contrôleur de batterie	Contactez le SAV ORI (batterie reliée en interne?)
10	Battery main alarm	Alarme principale batterie	Contactez le SAV ORI.
11	Battery pre-alarm	Pré-alarme batterie	Chargez X-zone Com.
12	Battery empty	Décharger complètement la batterie	Chargez X-zone Com.
14	Battery too cold	Température de la batterie basse	Interrompez le chargement et positionnez le X-zone Com dans un environnement plus chaud.
15	Charging error	Défaut de chargement batterie	Erreur de chargement batterie - Contactez le SAV ORI.
<b>Défaut GPS</b>			
16	GPS HW error	Le module GPS ne fonctionne pas	Contactez le SAV ORI.
17	GPS error	Erreur GPS non spécifiée	Contactez le SAV ORI.
<b>Défaut GSM</b>			
20	GSM modem error	Modem GSM ne fonctionne pas	Modem connecté en interne ?
21	No SIM card	Aucune carte SIM insérée	Insérer la carte SIM.
22	SIM not working	Carte SIM ne fonctionne pas	Mettez une nouvelle carte SIM.
23	SIM: Wrong PIN	Carte SIM : mauvais PIN	Configurez le bon PIN au moyen du Manager Software.
24	SIM blocked	Carte SIM bloquée : saisie PUK nécessaire	Placez la carte SIM dans un téléphone mobile et déverrouillez la carte en saisissant le PUK ( <i>Personal Unblocking Key</i> ).
25	Roaming error	<i>Roaming</i> non autorisé	Utilisez la carte SIM correspondante.
26	GSM error	GSM – erreur inconnue	Configurez et vérifiez les paramètres GSM/GPRS au moyen du Manager Software (voir chap. 5.4.3).
27	No GSM network	Aucun réseau GSM trouvé	Modifiez la position de l'appareil et vérifiez : <ul style="list-style-type: none"> <li>• La force du signal (voir chap. 5.4.3)</li> <li>• L'antenne</li> <li>• La validité de la carte SIM et son crédit</li> </ul>
28	Wrong APN login	Erreur d'authentification GPRS : mauvaises données APN	Au moyen du Manager Software, vérifiez l'exactitude des saisies suivantes : <ul style="list-style-type: none"> <li>• APN de votre prestataire en téléphonie mobile</li> <li>• Nom utilisateur</li> <li>• Mot de passe</li> </ul>
29	GPRS error	GPRS – erreur inconnue	Configurez et vérifiez les paramètres GSM/GPRS au moyen du Manager Software (voir chap. 5.4.3).
30	IP error	Aucune adresse IP reçue	Configurez et vérifiez les paramètres GSM/GPRS au moyen du Manager Software (voir chap. 5.4.3).
31	Unknown mail server	<i>Mail host name</i> ne peut être résolu (attribué)	Indiquez un nom de serveur e-mail valide.
<b>Défaut SMS</b>			
40	Unknown phone no.	Numéro de téléphone inconnu	Configuration au moyen du Manager Software.
41	SMS error	Erreur SMS inconnue	Configuration au moyen du Manager Software.
42	SMS not sent	Le SMS n'a pas pu être envoyé	Contrôlez : <ul style="list-style-type: none"> <li>• Les paramètres SMS au moyen du Manager Software.</li> </ul>

			<ul style="list-style-type: none"> <li>• Votre crédit pour les cartes prépayées</li> </ul>
43	Wrong PIN in SMS	SMS reçu avec mauvais PIN	Au moyen du Manager Software, mettez le "Lese-" et le "Admin-PIN" et utilisez ceux-ci lors de l'envoi d'un SMS au X-zone Com (voir chap. 5.4.5)
47	Unknown email user	Utilisateur e-mail inconnu	Au moyen du Manager Software, vérifiez : <ul style="list-style-type: none"> <li>• le nom d'utilisateur</li> <li>• le mot de passe</li> </ul>
48	Mailbox full	Boîte e-mail pleine	Contrôlez votre boîte e-mail
49	Email rejected	L'e-mail a été refusé	Vérifiez les paramètres e-mail au moyen du Manager Software
50	Email not sent	L'e-mail n'a pas pu être envoyé	Au moyen du Manager Software, contrôlez : <ul style="list-style-type: none"> <li>• la force du signal (voir chap. 5.4.3)</li> <li>• les paramètres e-mail</li> </ul>
<b>Erreurs système</b>			
85	No time set	Aucun réglage heure et date	Mettez la date et l'heure au moyen du Manager Software (voir chap. 5.4.1)
86	Incompatible SW	Erreur communication Modbus avec le X-zone 5x00	Actualisez le Software du X-zone 5x00 et du X-zone Com.
89	X-zone missing	Le X-zone 5x00 a été coupé du X-zone Com	Vérifiez : <ul style="list-style-type: none"> <li>• la liaison vers le X-zone 5x00.</li> <li>• Les paramètres Modbus dans le X-zone 5x00 (115200, E, 8,1)</li> </ul>

## 10.2 LISTE DE COMMANDE

Description	N° de commande ORI	N° de commande Dräger
<b>X-zone Com Set</b> –  II 2C Ex ib [Ia IIC Ga] [Ib IIC] IIB T3/T4 Gb		
Unité de communication pour Dräger X-zone 5x00	8094 100	8324383
<b>Chargeur/bloc réseau :</b>		
Chargeur	8094 114	8324374
Ligne réseau Europe	8094 142	8325391
Ligne réseau Grande-Bretagne	8094 141	8325392
Ligne réseau Australie	8094 140	8325393
<b>Pack batterie</b>	8094 106	8324376
<b>Câble de connexion :</b>		
RS232 pour la connexion X-zone Com / PC	8094 120	8324379
RS 485 pour la connexion X-zone Com / X-zone	8094 118	8324373
<b>Software</b>		
Manager Software pour paramétrage du X-zone Com	5415 045-2	
Licence Mcloud 12 mois	5415 061	8325346
Licence Mcloud 36 mois	5415 063	8325347
<b>Pièces détachées :</b>		
Kit de fixation (pour une liaison mécanique fiable entre le X-zone et le X-zone Com au moyen d'une sangle)	8094 117	
Jeu de sangles pour la fixation	8094 136	8324377
Socle pour le X-zone Com avec support de fixation	8094 135	8324384
<b>Pièces détachées :</b>		
Modem GSM-GPRS	5415 029	8324375
Pile/Batterie	8094 106	8324376
Antenne GSM X-zone Com	8094 108	8324372

## 10.3 MISE A JOUR DU MICROPROGRAMME

Pour une mise à jour du microprogramme du X-zone Com, vous avez besoin d'une connexion entre le PC et le X-zone Com via Bluetooth ou un câble RS232. En outre, le logiciel "FirmLoader.exe" et un fichier actuel de microprogramme "XCOM VX\_XXX.fmw". Vous obtiendrez ceux-ci auprès de votre service ORI ou Dräger compétent. Avant de poursuivre, calculez le numéro de COM-Port de votre connexion si celui-ci n'est pas connu (voir chap. 5.1). Puis procédez comme suit :

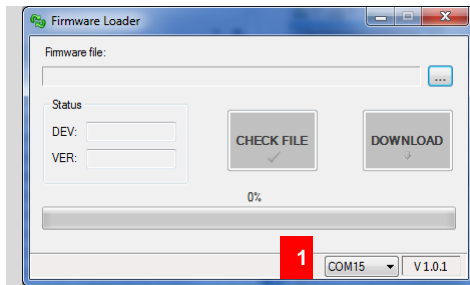

1 Démarrez "FirmLoader.exe" et sélectionnez le COM-Port.

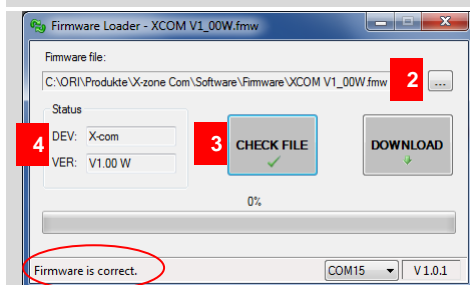

2 Sélectionnez le fichier actuel du microprogramme.

3 Cliquez sur la touche [CHECK FILE] pour vérifier le microprogramme sélectionné.

4 Dans les champs "DEV" et "VER" le type d'appareil et le numéro de version du microprogramme sélectionné s'affichent. Dans la barre d'état en bas à gauche un texte d'information apparaît.

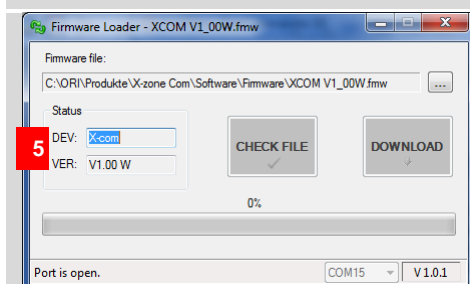

5 Contrôlez s'il s'agit d'un microprogramme pour un X-zone Com.

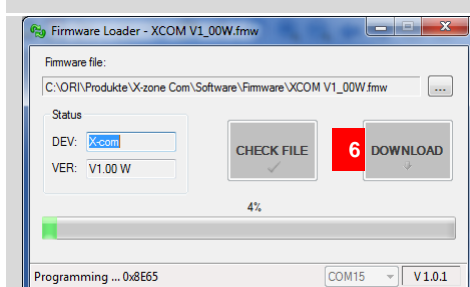

6 Cliquez maintenant sur [DOWNLOAD] pour enregistrer le microprogramme sur votre X-zone Com

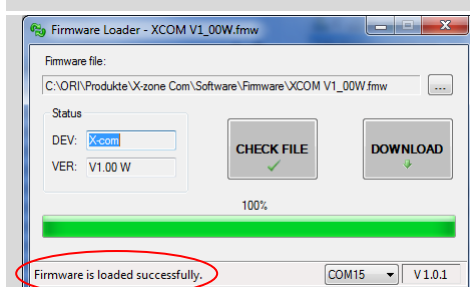

Si le microprogramme a été enregistré avec succès, ceci s'affiche dans la barre d'état en bas à gauche.

Fermez le "Firmware Loader" en cliquant sur .

**REMARQUE**



*Lors d'une connexion existante avec un X-zone 5X00 une alarme se produit pendant le TELECHARGEMENT.*

Si une mise à jour n'a pas abouti, veuillez vérifier toutes les connexions. Assurez-vous que dans le cas d'une connexion en Bluetooth, l'ordinateur reconnaisse votre X-zone Com et que la distance entre les deux appareils ne soit pas trop grande ou qu'elle soit gênée par des obstacles placés entre. Vérifiez le numéro du port COM.

Puis redémarrez la mise à jour.

## 10.4 CERTIFICATS

	<h1>IECEX Certificate of Conformity</h1>	
<b>INTERNATIONAL ELECTROTECHNICAL COMMISSION</b> <b>IEC Certification Scheme for Explosive Atmospheres</b> for rules and details of the IECEx Scheme visit <a href="http://www.iecex.com">www.iecex.com</a>		
Certificate No.:	<input type="text" value="IECEX FTZU 14.0013X"/>	issue No.: <input type="text" value="0"/>
Status:	<input type="text" value="Current"/>	
Date of Issue:	<input type="text" value="2014-06-13"/>	Page 1 of 3
Applicant:	<b>ORI-Abwassertechnik GmbH &amp; Co. KG</b> Bollacken 2, 32479 Hille Germany	
Electrical Apparatus: <i>Optional accessory:</i>	<b>Communication Equipment Device COM</b>	
Type of Protection:	<b>Intrinsic safety</b>	
Marking:	<b>Ex ib [ia IIC Ga] [ib IIC] IIB T3/T4 Gb</b>	
<i>Approved for issue on behalf of the IECEx Certification Body:</i>	Dipl. Ing. Lukáš Martinák	
<i>Position:</i>	Head of the Certification Body	
<ol style="list-style-type: none"><li>1. This certificate and schedule may only be reproduced in full.</li><li>2. This certificate is not transferable and remains the property of the issuing body.</li><li>3. The Status and authenticity of this certificate may be verified by visiting the Official IECEx Website.</li></ol>		
Certificate issued by:		



Physical Technical Testing Institute  
Ostrava – Radvanice



## EC-Type Examination Certificate

- (1)  
(2) **Equipment or Protective Systems Intended for Use  
in Potentially Explosive Atmospheres  
(Directive 94/9/EC)**

(3) EC-Type Examination Certificate Number:

**FTZÚ 14 ATEX 0048X**

- (4) Equipment or protective system: **Communication Equipment Device.COM**  
(5) Manufacturer: **ORI Abwassertechnik GmbH & Co. KG**  
(6) Address: **Bollacken 2, D-32479 Hille, Germany**  
(7) This equipment or protective system and any of acceptable variation thereto is specified in the schedule to this certificate and the documents therein referred to.  
(8) The Physical Technical Testing Institute, notified body number 1026 in accordance with Article 9 of the Council Directive 94/9/EC of 23 March 1994, certifies that this equipment or protective system has been found to comply with the Essential Health and Safety Requirements relating to the design and construction of equipment and protective systems intended for use in potentially explosive atmospheres given in Annex II to the Directive.

The examination and test results are recorded in confidential Report N°:

**14/0048 dated 13.06.2014**

- (9) Compliance with Essential Health and Safety Requirements has been assured by compliance with:  
**EN 60079-0:2012, EN 60079-11:2012, EN 60079-26:2007**  
(10) If the sign "X" is placed after the certificate number, it indicates that the equipment or protective system is subject to special conditions for safe use specified in the schedule to this certificate.  
(11) This EC-Type Examination Certificate relates only to the design, examination and testing of the specified equipment or protective system in accordance to the directive 94/9/EC. Further requirements of the Directive apply to the manufacturing process and supply of this equipment or protective system. These are not covered by this certificate.  
(12) The marking of the equipment or protective system shall include following:

 **II 2G Ex ib [ia IIC Ga] [ib IIC] IIB T3/T4 Gb**

This EC-Type Examination Certificate is valid till: **13.06.2019**

Responsible person:

  
Dipl. Ing. Lukáš Martinák  
Head of Certification Body



Date of issue: 13.06.2014

Page: 1/4

This certificate is granted subject to the general conditions of the FTZÚ, s.p.  
This certificate may only be reproduced in its entirety and without any change, schedule included.

FTZÚ, s.p., Pikartská 1337/7, 716 07 Ostrava-Radvanice, Czech Republic,  
tel +420 595 223 111, fax +420 596 232 672, ftzu@ftzu.cz, www.ftzu.cz





Physical Technical Testing Institute  
Ostrava – Radvanice



## Supplement No. 1 to EC-Type Examination Certificate

- (1)
- (2) **Equipment or Protective Systems Intended for Use  
in Potentially Explosive Atmospheres  
(Directive 94/9/EC)**

(3) EC-Type Examination Certificate Number:

**FTZÚ 14 ATEX 0048X**

(4) Equipment or protective system: **Communication Equipment Device.COM**

(5) Manufacturer: **ORI Abwassertechnik GmbH & Co. KG**

(6) Address: **Bollacken 2, D-32479 Hille, Germany**

- (7) This supplement of certificate is valid for:
- modification of certified apparatus
  - modification of apparatus marking
  - new model (variant) external power supply **02617PS**
- (8) Modification of certified apparatus (protective system) and any of its approved variants are specified in documentation, list of which is mentioned in schedule of this certificate.
- (9) This supplement to type examination certificate is valid only for type examination of design and construction of product sample in accordance with Annex 3 Paragraph 6) of Directive No. 94/9/EC. The Directive contains another requirements, which manufacturer shall fulfil before products are placed on market or introduced in service.
- (10) Safety requirements of modified parts were fulfilled by satisfying the following standards:  
**EN 60079-0:2012, EN 60079-11:2012, EN 60079-26:2007**
- (11) Marking of equipment shall contain symbols:

 **II 2G Ex ib [ia IIC Ga] [ib IIC] IIB T3/T4 Gb**

 **II (2)G [Ex ib Gb] IIB** zdroj 02617PS

(12) This type examination certificate is valid till: **13.06.2019**

Responsible person:

  
Dipl. Ing. Lukáš Martinák  
Head of Certification Body



Date of issue: 20.10.2014

Page: 1/3

This supplement to certificate is granted subject to the general conditions of the FTZÚ, s.p.  
This supplement to certificate may only be reproduced in its entirety and without any change, schedule included.

FTZÚ, s.p., Pikartská 1337/7, 716 07 Ostrava-Radvanice, Czech Republic,  
tel +420 595 223 111, fax +420 596 232 672, ftzu@ftzu.cz, www.ftzu.cz



# X-zone COM

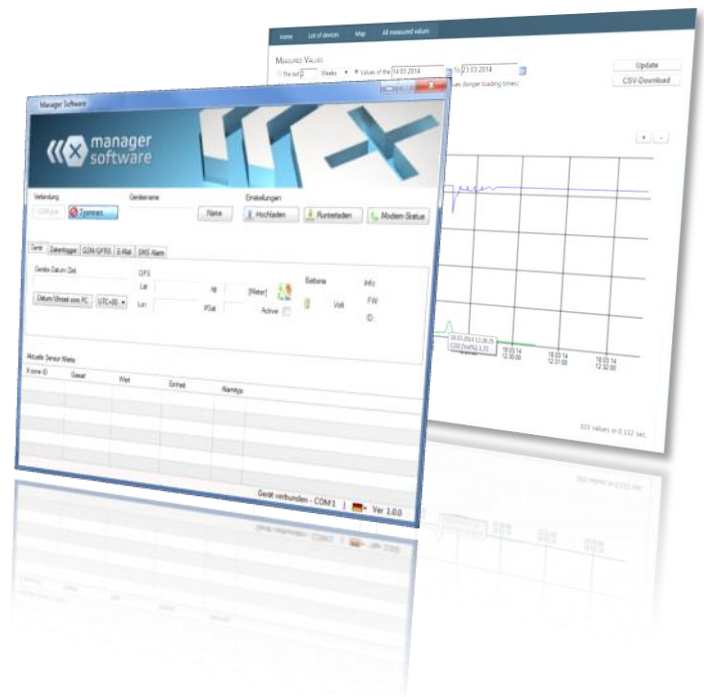

X-zone Com  II 2G Ex ib [ia IIC Ga] [ib IIC] IIB T3/T4 Gb  
Modello: 02617

## Istruzioni per l'uso

Rev20141022-01

N° art. 8094130

---

## Traduzione

Nel caso in cui la traduzione contenesse delle inesattezze, consultare le istruzioni per l'uso originali (in lingua tedesca) o contattare il produttore.

## Copyright

La trasmissione e la riproduzione in copie di questo documento nonché l'utilizzazione e comunicazione del suo contenuto sono vietati se non espressamente permessi. Eventuali trasgressioni comportano il risarcimento danni. Tutti i diritti riservati.

## Nomi d'uso

La riproduzione di nomi d'uso, nomi commerciali, denominazioni merceologiche e simili in questo documento non autorizza a presumere che tali nomi potrebbero essere utilizzati senza problemi da chiunque; spesso si tratta di marchi registrati protetti dalla legge, anche se non contrassegnati come tale.

## Licenza:

Questo documento non sostituisce la Documentazione tecnica dei certificati validi. In caso di bisogno, richiedere questa Documentazione tecnica alla società ORI GmbH & Co.KG.

## Impiego in zone a rischio di esplosione

I dispositivi o componenti usati in zone a rischio di esplosione e collaudati e certificati secondo le direttive di protezione antideflagrante nazionali, europei e internazionali possono essere impiegati soltanto alle condizioni indicate nel certificato e in osservanza delle disposizioni di legge pertinenti.

**È vietato apportare delle modifiche a materiali d'esercizio, dispositivi o componenti. Non è consentito utilizzare parti difettose o incomplete.** In caso di riparazioni di questo dispositivo o di componenti è d'obbligo osservare le relative disposizioni.

Il dispositivo deve essere sottoposto ad intervalli regolari ad ispezioni e manutenzioni a cura di personale esperto.



**Leggere attentamente  
prima della messa in funzione!**

---

(Inserire qui il numero di serie dell'X-zone Com)

# INDICE

<b>1</b>	<b>Generalità.....</b>	<b>5</b>
1.1	Descrizione funzionaleE .....	5
1.2	Utilizzo conforme .....	5
1.3	Magazzinaggio e restituzione .....	6
1.4	Smaltimento .....	6
<b>2</b>	<b>Avvisi di sicurezza.....</b>	<b>7</b>
2.1	Segni di sicurezza e simboli .....	7
2.2	Istruzioni per la sicurezza .....	8
2.3	Sicurezza di funzionamento.....	8
<b>3</b>	<b>Struttura e dati tecnici.....</b>	<b>9</b>
3.1	Dimensioni .....	9
3.1.1	X-zone Com + X-zone 5x00 .....	9
3.1.2	Caricabatterie I.S. Power supply 02617PS .....	10
3.2	Interfacce dell'X-zone Com e del caricabatterie .....	10
3.2.1	X-zone Com: .....	10
3.2.2	Caricabatterie I.S. Power supply 02617PS .....	12
3.3	Marcatura.....	13
3.4	Specifiche del dispositivo.....	14
3.4.1	X-zone Com.....	14
3.4.2	Caricabatterie.....	15
<b>4</b>	<b>Installazione e messa in funzione .....</b>	<b>16</b>
4.1	Installazione del Manager Software .....	16
4.1.1	Requisiti di sistema .....	16
4.1.2	Installazione del Manager Software .....	16
4.2	Prima messa in funzione .....	18
4.2.1	Carica della batteria .....	18
4.2.2	Inserimento della carta SIM .....	19
4.2.3	Montaggio/smontaggio antenna .....	21
4.2.4	Collegamento con l'X-zone 5x00 .....	22
4.3	Scollegamento dall'X-zone 5x00 .....	24
<b>5</b>	<b>Configurazione dell'X-zone com.....</b>	<b>25</b>
5.1	Creazione di un collegamento al PC .....	25
5.1.1	Collegamento Bluetooth .....	25
5.1.2	Collegamento via cavo .....	26
5.2	Visione generale/finestra di avvio.....	27
5.3	Informazioni sui collegamenti .....	28
5.3.1	Creazione di un collegamento all'X-zone Com.....	28
5.3.2	Modifica nome del dispositivo / del luogo di misura .....	29
5.3.3	Memorizzazione e caricamento delle impostazioni dell'X-zone Com.....	30
5.3.4	Visualizzazione dello storico dati .....	30
5.4	Configurazione dell'X-zone Com .....	32

5.4.1	Modulo " <i>Dispositivo</i> " .....	33
5.4.2	Modulo " <i>Logger dati</i> " .....	34
5.4.3	Modulo " <i>GSM/GPRS</i> " .....	35
5.4.4	Modulo " <i>Email</i> " .....	36
5.4.5	Modulo " <i>SMS</i> " .....	38
5.4.6	Modulo " <i>Status</i> " (Stato) .....	39
5.5	Area valori misurati: .....	40
<b>6</b>	<b>L'uso dell'<i>X-zone Com</i> .....</b>	<b>41</b>
6.1	Pannello di comando .....	41
6.2	Attivazione del dispositivo.....	41
6.3	Disattivazione del dispositivo.....	42
6.4	Visualizzazioni sul display .....	42
6.4.1	Quadro d'insieme simboli.....	42
6.4.2	Visualizzazioni di errore .....	43
6.5	Effettuazione del controllo funzionale.....	44
<b>7</b>	<b>Invio <i>SMS</i> all'<i>X-zone Com</i> .....</b>	<b>45</b>
7.1	Comandi <i>SMS</i> di lettura.....	45
7.1.1	Richiesta di stato .....	46
7.1.2	Richiesta di informazioni sullo stato del gruppo .....	47
7.1.3	Valori misurati dell' <i>X-zone 5x00</i> collegato localmente .....	48
7.1.4	Richiesta dei valori massimi in un gruppo .....	49
7.1.5	Visualizzazione delle coordinate <i>GPS</i> .....	50
7.1.6	Richiesta di allarmi attuali .....	51
7.2	Comandi <i>SMS</i> esecutivi.....	53
7.2.1	Accettazione allarme .....	53
7.2.2	Attivazione allarme di evacuazione .....	53
7.2.3	Disattivazione dell'allarme di evacuazione .....	54
<b>8</b>	<b>Breve descrizione del <i>Mcloud</i> .....</b>	<b>55</b>
8.1	Elenco dispositivo <i>Mcloud</i> .....	55
8.2	Stato del dispositivo <i>Mcloud</i> .....	57
8.3	Valori misurati <i>Mcloud</i> .....	58
8.4	Rappresentazione mappa <i>Mcloud</i> .....	59
<b>9</b>	<b>Manutenzione .....</b>	<b>61</b>
9.1	Intervalli.....	61
9.2	Pulizia .....	61
9.3	Sostituzione della batteria in caso di riparazioni.....	61
<b>10</b>	<b>Appendice .....</b>	<b>62</b>
10.1	Codici errore .....	62
10.2	Elenco per ordinazione .....	63
10.3	Update del firmware.....	64
10.4	Certificati .....	66

# 1 GENERALITÀ

## 1.1 DESCRIZIONE FUNZIONALE

Il dispositivo di localizzazione e comunicazione X-zone Com è previsto per l'impiego in ambienti industriali. Esso integra il sistema di rilevazione gas Dräger X-zone 5x00 con Dräger X-am 5x00 (in seguito chiamato X-zone 5x00 ).

Collegato ad un X-zone 5x00, l'X-zone Com legge regolarmente dall'X-zone 5x00 le concentrazioni di gas e i valori d'allarme e li memorizza temporaneamente fino al momento in cui può trasmetterli al server di ORI Mcloud o ad un destinatario di e-mail determinato dall'utente. Se l'X-zone 5x00 (cordless o via cavo) è collegato ad altri X-zone 5x00, vengono inoltre trasmessi i valori d'allarme della rete. In caso di una rete di X-zone chiusa (gruppo), invece dei valori di gas misurati dall'X-zone 5x00 collegato vengono lette, memorizzate e trasmesse le concentrazioni massime di gas del gruppo.

L'X-zone Com aggiunge a tutti i valori misurati dall'X-zone 5x00 i dati di posizione e ha potuto rilevare una posizione GPS.

Inoltre è in grado di ricevere richieste di stato via SMS e di risponderle via SMS, e invia sia delle e-mail che degli SMS in caso di allarme.

Tramite Bluetooth o un collegamento seriale l'utente può configurare l'X-zone Com con l'aiuto di un software per il PC (in seguito chiamato Manager Software).

## 1.2 UTILIZZO CONFORME

L'X-zone Com può essere usato in ambienti a rischio di esplosioni della zona 1 e 2 (secondo  Il **2G Ex ib [ja IIC Ga] [ib IIC] IIB T3/T4 Gb**) insieme all'amplificatore di allarme Dräger X-zone 5x00. L'utilizzo diverso da quello previsto o la modifica del dispositivo senza accordo scritto con il produttore è considerato improprio e ha come conseguenza la perdita della certificazione ATEX e della garanzia.

Il produttore non risponde di danni risultanti da un utilizzo improprio o diverso dallo scopo, il rischio viene assunto soltanto dall'utilizzatore. Il dispositivo può essere fonte di rischi se viene impiegato in modo improprio o diverso dallo scopo. Se si nota che non è più possibile utilizzare il dispositivo senza correre rischi, lo si deve spegnere il dispositivo deve immediatamente.

L'utilizzo conforme include anche la conoscenza e l'osservanza delle istruzioni per l'uso.

### AVVERTIMENTO



*Leggere attentamente il manuale d'uso separato del Dräger X-zone 5x00 e dei misuratori di gas Dräger X-am 5x00 collegati. Osservare in particolare i relativi avvisi di sicurezza.*

---

## 1.3 MAGAZZINAGGIO E RESTITUZIONE

---

**Magazzinaggio:** Sconnettere gli eventuali collegamenti esistenti con l'X-zone 5x00. Si prega di osservare le prescrizioni del produttore per l'X-zone 5x00. Depositare l'X-zone Com spento con il caricabatterie collegato fuori dalla zona a rischio di esplosione e non all'aperto. In caso di stoccaggio senza caricabatterie la batteria ricaricabile interna deve essere completamente caricata per 48 ore, al più tardi dopo 6 mesi.

**Restituzione:** Prima di restituire il dispositivo a ORI Abwassertechnik GmbH & Co. KG, ad es. a fine di riparazioni, sono da prendere le seguenti misure:

- Rimuovere tutte le impurità. Questo è di particolare importanza se le impurità sono pericolose per la salute, ad es. infiammabili, velenose, caustiche, cancerogene, ecc.

Le spese che a causa di una pulizia insufficiente del dispositivo, devono essere sostenute per un eventuale smaltimento di rifiuti speciali o per danni alle persone (corrosioni ecc.) verranno messe in conto all'utilizzatore.

## 1.4 SMALTIMENTO

---

**Imballo:** Conservare l'imballo del dispositivo per un futuro utilizzo nel trasporto. Gli altri materiali da imballo come legno, cartone e PE possono essere sottoposti agli usuali metodi di smaltimento.

**X-zone Com:** Non può essere smaltito come rifiuto urbano (ai sensi della direttiva 2002/96/UE). Fare attenzione all'ecocompatibilità, ai rischi per la salute e ai regolamenti per lo smaltimento locali. Pertanto, pulire e disinfettare il dispositivo e smaltirlo in uno dei centri di raccolta competenti. Per ulteriori informazioni rivolgersi alle autorità competenti. In caso di consegna franco domicilio, provvederemo, a richiesta, allo smaltimento gratuito del vostro vecchio X-zone Com. Considerare a questo proposito la sezione "Restituzione" nel capitolo precedente.



**Blocco batteria ricaricabile:** Il blocco batteria contenuto nell'X-zone Com non può essere smaltito come rifiuto urbano (ai sensi della direttiva 2006/66/UE). Conformemente alle norme vigenti deve essere smaltito nei centri locali di raccolta batterie.

## 2 AVVISI DI SICUREZZA

### 2.1 SEGNI DI SICUREZZA E SIMBOLI

Un uso corretto e sicuro del dispositivo l'apparecchio è garantito solo se si osservano attentamente le indicazioni inerenti alla sicurezza contenute nelle istruzioni per l'uso. Le indicazioni sulla sicurezza riportate nel presente manuale indicano il grado di pericolosità prevedibile e sono contrassegnate con i seguenti simboli e colori:

**AVVISO**



*Gli avvisi indicano potenziali situazioni di pericolo che possono comportare gravi lesioni / morte di persone o un rischio per la sicurezza. Osservare attentamente le istruzioni operative e adottare le necessarie misure precauzionali.*

**ATTENZIONE**





*Con „Attenzione“ si indicano potenziali situazioni di pericolo che, se non trattate con le dovute misure precauzionali, possono comportare lesioni, funzionamento difettoso o danni all'apparecchio o all'ambiente. Osservare attentamente le istruzioni.*

**AWERTIMENTO**



*Indicazioni, informazioni o suggerimenti di carattere generale, tuttavia non indicazioni di pericolo.*

Altri simboli:

Simbolo	Spiegazione
	Indossare indumenti di protezione
	Leggere le istruzioni per l'uso

---

## 2.2 ISTRUZIONI PER LA SICUREZZA

---

Le seguenti istruzioni per la sicurezza per l'X-zone Com devono essere eseguite attentamente.

**ATTENZIONE**



*Il dispositivo deve essere periodicamente sottoposto ad ispezioni e manutenzioni a cura di personale esperto (vedi IEC 60079-1).*

**AVVISO**



**Pericolo di esplosione!**  
*In caso di danni dell'alloggiamento o di parti di esso il dispositivo deve immediatamente essere spento e protetto dalla messa in funzione involontaria.*

**AVVISO**



**Pericolo di esplosione!**  
*Effettuare gli interventi di riparazione, assistenza e manutenzione esclusivamente in un ambiente non a rischio di esplosione.*

**AVVISO**



**Pericolo di morte!**  
*Osservare tassativamente le istruzioni per la sicurezza dei dispositivi Dräger X-zone 5x00 e Dräger X-am 5x00!*

---

## 2.3 SICUREZZA DI FUNZIONAMENTO

---

**Riparazioni:** Le riparazioni e altri interventi sul dispositivo non descritti in questo manuale d'uso, devono essere effettuati soltanto direttamente presso il produttore o da un Servizio di assistenza autorizzato dal produttore stesso.

**Progresso tecnico:** Il produttore si riserva di adattare i dati tecnici allo sviluppo tecnico senza particolare preavviso. La ORI Abwassertechnik GmbH & Co. KG si occupa di informare su attività e eventuali ampliamenti di questo manuale.



## 3 STRUTTURA E DATI TECNICI

Le indicazioni in questo manuale d'uso si riferiscono soltanto al tipo di dispositivo indicato nel frontespizio.

L'X-zone Com è dotato di una batteria ricaricabile incorporata che alimenta il dispositivo nelle zone ATEX (secondo la direttiva 94/9/CE). Per l'uso dei pannelli di comando viene utilizzata la penna magnetica in dotazione. È installato un GSM/GPRS per la trasmissione di allarmi, stato e dati. I dati trasmessi dall'X-zone 5x00 vengono salvati in una memoria dati interna. Possono essere memorizzati ca. 262.000 record dati. La memoria dati è realizzata come memoria ciclica in modo che quando vengono superati i 262.000 record, quelli più vecchi vengono sovrascritti.

### 3.1 DIMENSIONI

#### 3.1.1 X-zone Com + X-zone 5x00

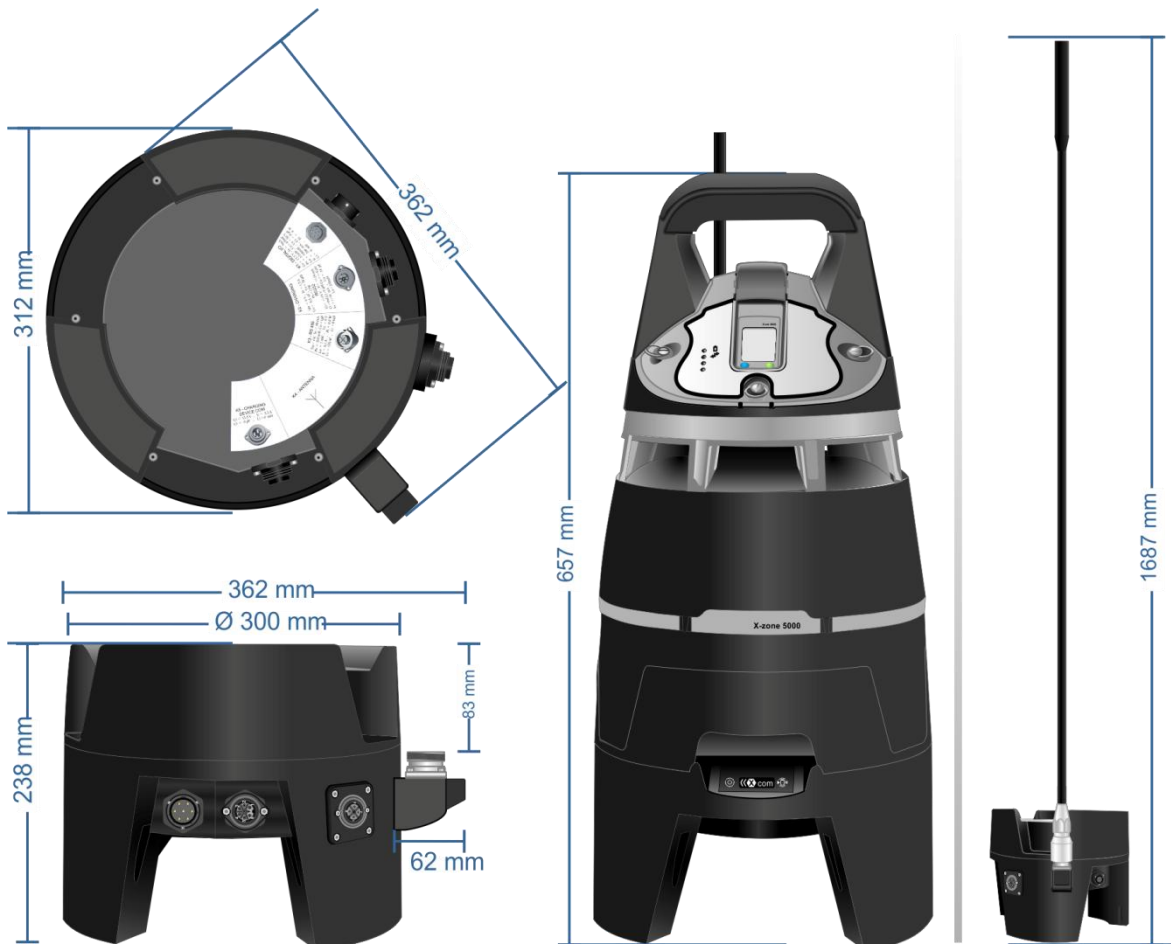

Fig. 3.1: Dimensioni di X-zone Com e di X-zone Com con X-zone 5x00.

### 3.1.2 Caricabatterie I.S. Power supply 02617PS

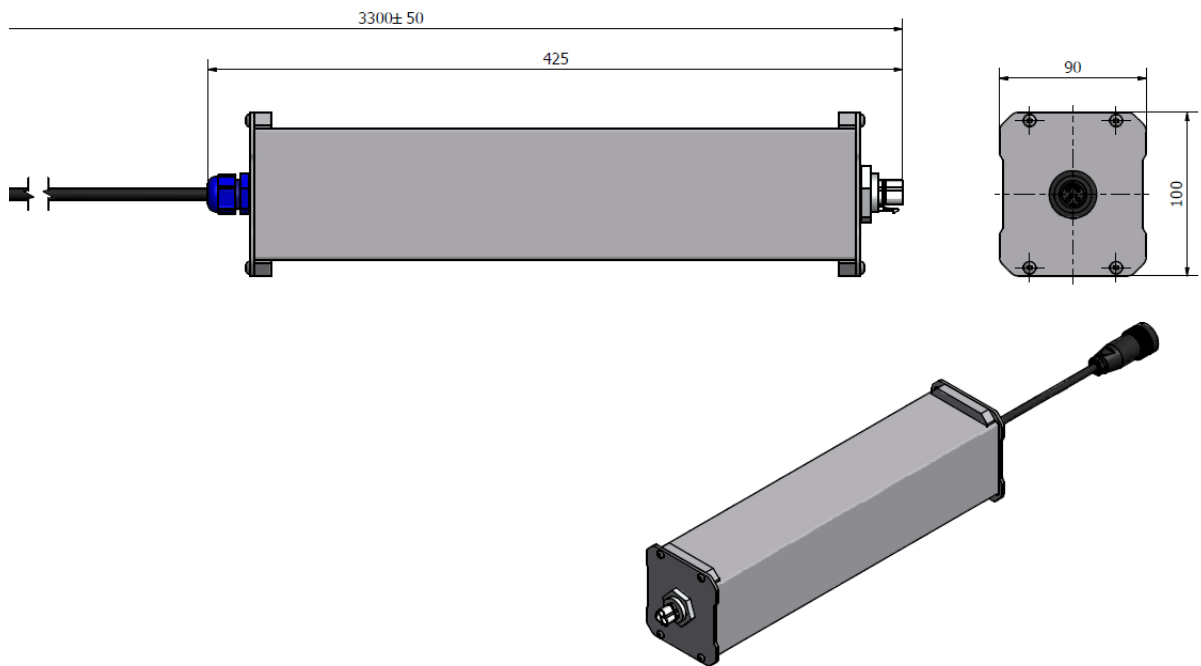

Fig. 3.2: Dimensioni caricabatterie in mm

## 3.2 INTERFACCE DELL'X-ZONE COM E DEL CARICABATTERIE

### 3.2.1 X-zone Com:

L'X-zone Com è dotato di diverse interfacce per la trasmissione dati (K3=RS485, K2=RS232), un ingresso/uscita digitale (K1), un connettore per il caricabatterie (K5) e di una base per l'antenna GSM/GPRS (K4).

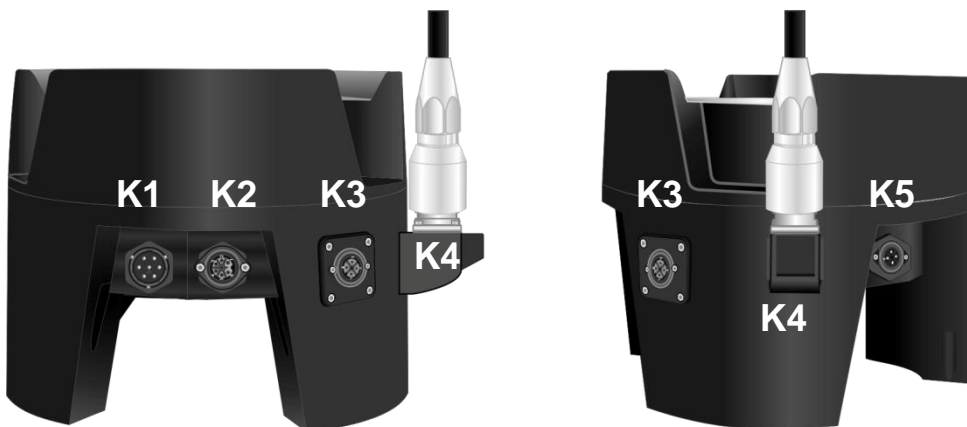







Fig. 3.3: Disposizione interfacce dell' X-zone Com.

	Funzione	Versione	Vista	Assegnazione
<b>K1</b>	I / O digitale	Connettore a 7 poli		3. GND 4. Normally closed (NC) 5. Normally open (NO) 6. Common (COM) 7. Input
<b>K2</b>	RS232 Interfaccia seriale (DTE)	Pres a 7 poli		1. TxD 2. CTS 3. RTS 4. Caricamento + 5. Caricamento GND 6. GND (RS232) 7. RxD
<b>K3</b>	RS485 collegamento X-zone 5x00	Pres a 3 poli +PE		1. POSITIVO (+) 2. NEGATIVO (-) 3. GND
<b>K4</b>	Pres a antenna	Pres a HF 7/16 DIN		
<b>K5</b>	Allacciamento per caricamento X-zone Com:	Connettore a 3 poli + PE		1. Caricamento + 2. Caricamento GND
	Batteria ricaricabile interna	Connettore a 7 poli		1. Comunicazione (SCL) 2. Comunicazione (SDA) 3. RESET 4. Uscita utenza (+) 5. Utenza GND 6. Ingresso sorgente esterna (+) 7. Ingresso sorgente esterna (GND)

## 3.2.2 Caricabatterie I.S. Power supply 02617PS

Il cavo di alimentazione del caricabatterie è disponibile in tre differenti versioni:

Con spina d'alimentazione	Stato / Regione	No. ordinazione ORI	No. ordinazione Dräger
CEE 7/7	Europa	In dotazione	8325 391
AS3112	Australia	8094 140	8325 393
BS 1363	Gran Bretagna	8094 141	8325 392

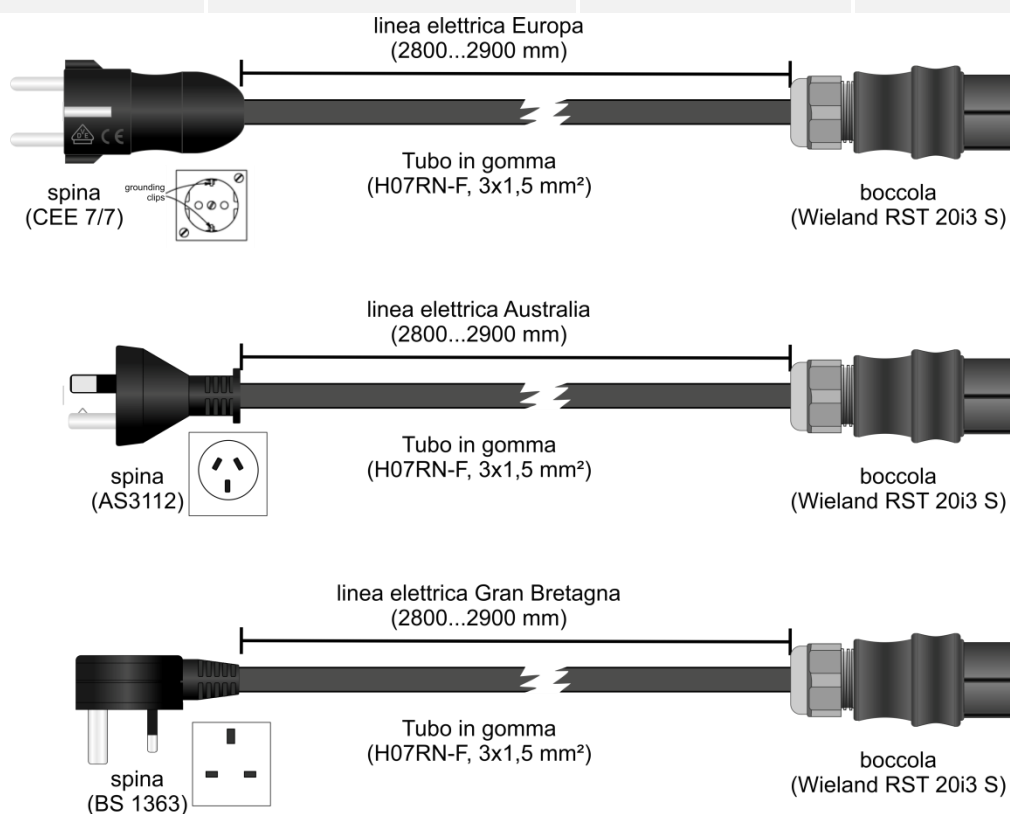
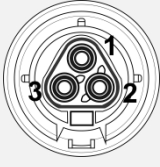



Fig. 3.4: Cavo di alimentazione del caricabatterie (per Europa, Australia, Gran Bretagna).

Funzione	Versione	Vista	Assegnazione
<b>Spina d'alimentazione</b>	CEE 7/7		
<b>Connettore ingresso</b>	Wieland RST20i3S a 3 poli		1. L1 (nero) 2. N (blu) 3. PE (verde/giallo)
<b>Presca uscita</b>	Connettore RD24 serie 693 - a 3 poli +PE		1. POSITIVO (+) 2. GND 3. Normally closed (NC) 4. Normally closed (NC)

### 3.3 MARCATURA

La targhetta è disposta sulla parte superiore dell' X-zone Com e riporta i seguenti dati:

- Nome del dispositivo
- Nome e indirizzo del produttore
- Marcatura CE
- Contrassegno della serie e il numero del modello
- Numeri di serie, l'anno di costruzione è compreso nel numero di serie
- Ente di certificazione, anno di omologazione, numero di omologazione e tipo di protezione dell'alloggiamento.
- Marcatura EX

Per tutte le richieste di chiarimento e ordinazioni di ricambi è importante indicare il nome del dispositivo e il numero di serie.

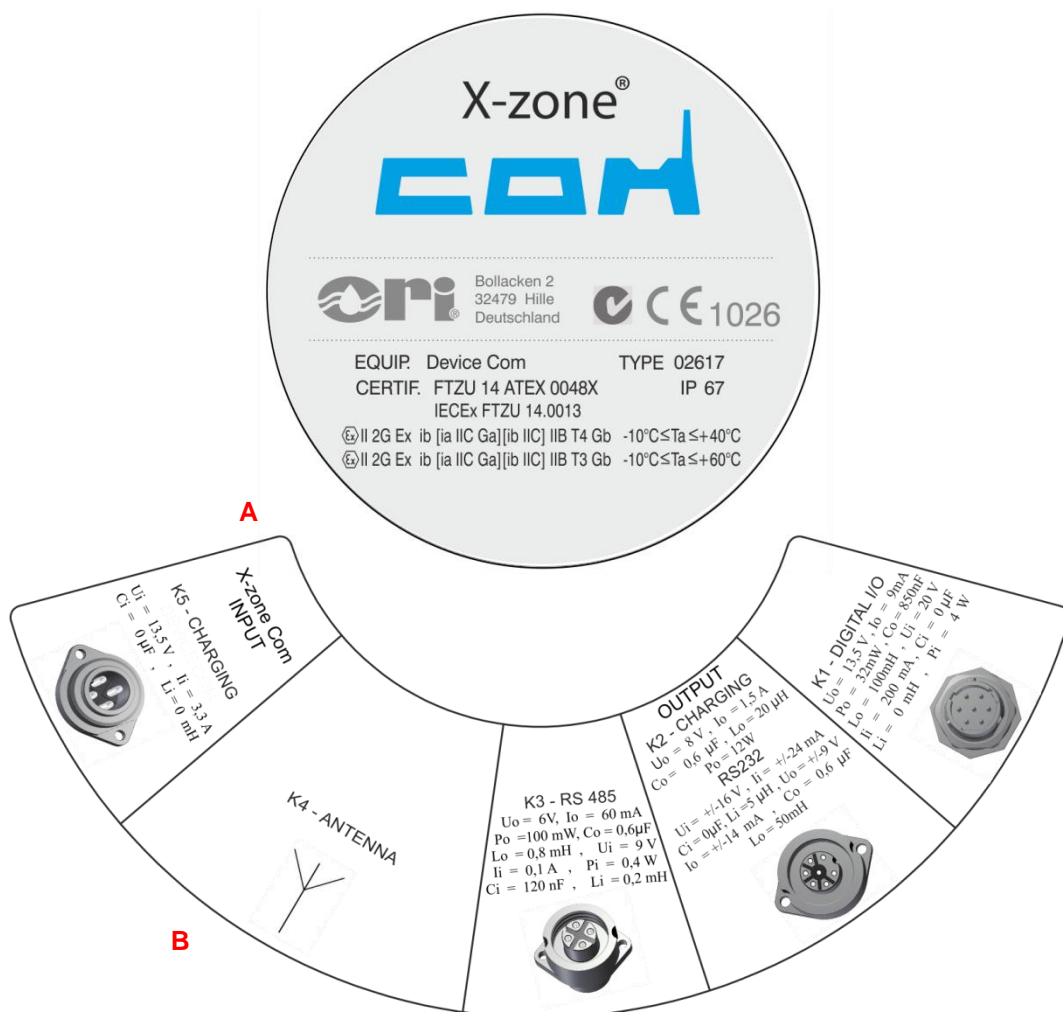

Fig. 3.5: **A)** Targhetta dell'X-zone Com sulla parte superiore dell'alloggiamento  
**B)** Informazioni per l'allacciamento sulla parte inferiore dell'alloggiamento

## 3.4 SPECIFICHE DEL DISPOSITIVO

### 3.4.1 X-zone Com:

Dati tecnici: X-zone Com:	
ATEX / IECEX Marcatura	⊕IECEX FTZU 14.0013X Ex ib [ia IIC Ga] [ib IIC] IIB T3/T4 Gb
Grado di protezione IP	<b>IP 67</b> (con connessioni a spina chiuse)
Dimensioni (ØXH); Peso	362 x 238 mm; 9,8 kg (senza Dräger X-zone 5x00)
Range di temperature	<b>Temperatura ambiente</b> -10°C .. + 60°C, gruppo temperature T3 -10°C .. + 40°C, gruppo temperature T4 <b>Temperatura di stoccaggio</b> -20°C .. + 60 °C (senza batteria) 0°C .. +50°C (batteria) 0°C .. + 50°C (caricabatterie) <b>Funzionamento ricarica e in tampone</b> +30°C (tempo di ricarica 30 ore) (con disattivazione durante la ricarica in caso a 0°C e superiore a +45°C)
Umidità atmosferica relativa	5 - 95%
Memoria dati interna	8 MB – ca. 262000 record dati
Batteria ricaricabile interna (NiMh)	Tensione nominale in uscita 12 V Tensione in uscita max. 15 V Corrente nominale in uscita 0,92 A Capacità 13,5 Ah Interna ricaricabile a 9...15 VDC / 1,5A
Comunicazione wireless	<b>Bluetooth</b> v3.0; classe 1 (antenna interna), 4dBm ERP <b>GSM/GPRS</b> modem MgsM Quad Band 850/900/1800/1900 MHz Dual Band 900 /1800 MHz <b>Antenna</b> (da fabbrica)
Interfacce fisiche a sicurezza intrinseca	<b>1 x RS485 (K3)</b> allacciamento Dräger X-zone 5x00 <b>1 x RS232 (K2)</b> RS232 + opzione caricamento dispositivi di terzi <b>1 x DI/DO (K1)</b> per Switch ON/OFF Box opzionale <b>1 x K5</b> X-zone Com alimentatore/caricabatteria <b>1 x HF 7/16 DIN (K4)</b> antenna
Modulo GPS	con antenna interna
Display	OLED
Standard armonizzati applicati	ETSI EN 300 328 V1.7.1:2006; ETSI EN 301 489-1 V.1.8.1:2008 : ETSI EN 301 489-7/V1.3.1:2005; ETSI EN 301 489-17/ V2.1.1:2009; ETSI EN 301511 V9.02:2003; EN 60079-0: 2012; EN 60079-11:2012; EN 60079-26: 2007 EN 50581:2012; EN 60950-1:2006; EN 61000-6-2:2005; EN 61000-6-3:2007
Direttiva UE applicata	94/9/EC - ATEX 2004/108/EC - EMC 1999/5/EC - R&TTR

### 3.4.2 Caricabatterie

Dati tecnici: caricabatterie I.S. Power Supply Unit 0217PS		
Grado di protezione IP	IP 65	⊕ II (2)G [Ex ib Gb] IIB
Classe di isolamento elettrico	I	
Dimensioni (L x L x H); Peso		425 x 90 x 100 mm senza cavo 3300 ± 50 x 90 x 100 con cavo 1 kg
Temperatura ambiente durante la carica		+5C..+30°C ( <i>tempo di ricarica 30 ore</i> ) ( <i>con disattivazione durante la ricarica in caso di temperature della batteria inferiore a 0°C e superiore a +45°C</i> )
Umidità atmosferica relativa	≤ 90%	
Dati elettrici	<b>Tensione in uscita</b>	90-230 VAC; 47 - 63 Hz 135-370 VDC;
	<b>corrente di ingresso</b>	1 A
	<b>Tensione nominale in uscita</b>	12 VDC (nominale)
	<b>Corrente nominale in uscita</b>	2 A (permanente)
Specifiche a sicurezza intrinseca	<b>U<sub>o</sub></b>	13,5 V
	<b>I<sub>o</sub></b>	2,8 A
	<b>C<sub>o</sub></b>	50 μF
	<b>L<sub>o</sub></b>	30 μH

## 4 INSTALLAZIONE E MESSA IN FUNZIONE

Prima della prima messa in funzione l'X-zone Com deve essere configurato tramite il software del PC (ORI Manager Software). La procedura di installazione del Manager Software sul PC è illustrata nella parte sottostante. A seguire sono descritte le operazioni meccaniche per la messa in funzione dell'X-zone Com.

### 4.1 INSTALLAZIONE DEL MANAGER SOFTWARE

#### 4.1.1 Requisiti di sistema

Per l'installazione del Manager Software devono essere soddisfatti i seguenti requisiti:

- Sistema operativo Microsoft Windows XP / Vista / 7 / 8 - 32bit o 64bit
- Microsoft .NET Framework installato
- 10 MB ca. di memoria su disco (senza .NET Framework)

#### AVVERTIMENTO



*Il Microsoft .NET framework può essere scaricato gratuitamente dal sito web di Microsoft. Fate attenzione a scaricare la versione adatta per il vostro sistema operativo (32 Bit oppure 64 Bit). In caso di problemi contattate il vostro tecnico informatico.*

#### 4.1.2 Installazione del Manager Software

Inserire il CD, la procedura di installazione inizia automaticamente. Se l'installazione non inizia automaticamente, aprire il file "setup.exe" o "manager\_setup.msi" dal media di installazione e seguire le istruzioni.

#### AVVERTIMENTO



*Questo programma informatico è protetto dalla legge sulla protezione dei diritti d'autore e da contratti internazionali. È vietata la riproduzione o commercializzazione di questo programma o parti di esso.*

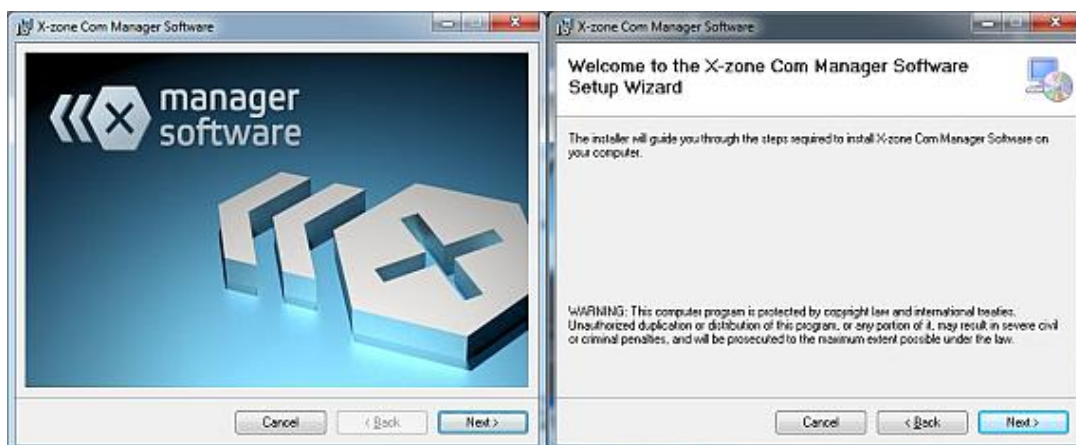



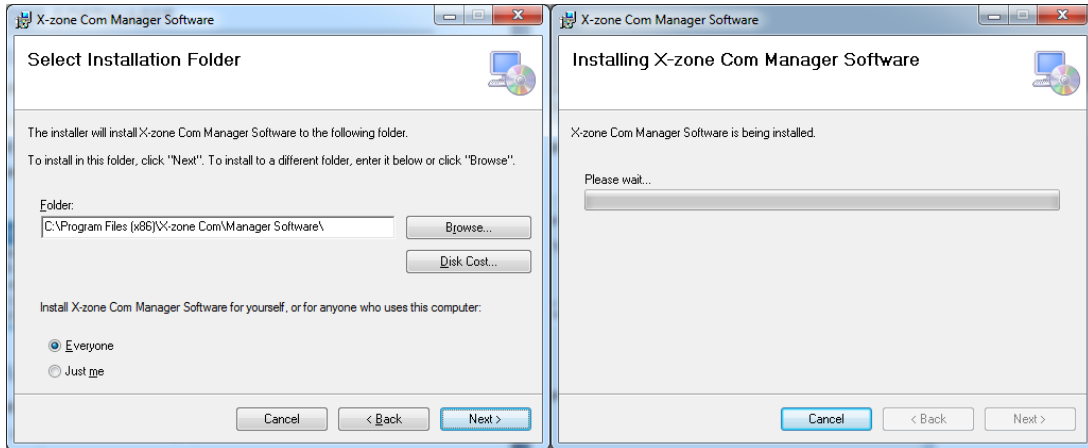

Fig. 4.1: Assistente di installazione del Manager Software

Il Manager Software viene installato di norma nella seguente directory:

```
c:\ Program Files (x86)\X-zone Com\Manager Software\
```

Per scegliere una directory diversa cliccare su [Browse...] o inserire il percorso di memoria direttamente nel campo sotto "Folder:"

Con la selezione di [Everyone] si accede all'installazione del software per tutti gli utenti del PC.

Con la selezione di [Just me] si accede all'installazione del software solo per l'utente attualmente registrato.

Per installare il programma in questa directory cliccare su [Next>]. Sul desktop verrà automaticamente creata una connessione al programma.

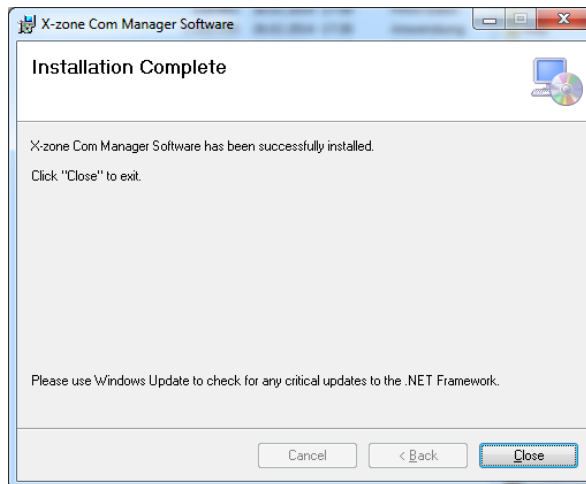

Fig. 4.2: Installazione terminata

Appena l'installazione è terminata con esito positivo, chiudere l'assistente di installazione cliccando su [Close].

## 4.2 PRIMA MESSA IN FUNZIONE



I lavori di montaggio, l'allacciamento elettrico, la messa in funzione, l'uso e la manutenzione dell'X-zone Com devono essere eseguiti esclusivamente da personale qualificato e specializzato. Il personale specializzato deve aver letto e capito le istruzioni per l'uso. Durante l'installazione, il funzionamento, la manutenzione e il trasporto indossare l'abbigliamento protettivo obbligatorio. Prima di azionare il sistema, controllare che gli allacciamenti siano corretti.

### 4.2.1 Carica della batteria

Durante la carica dell'X-zone Com, l'allacciamento dell'alimentatore/caricabatterie (di seguito chiamato alimentatore) alla tensione di alimentazione deve trovarsi fuori da un'atmosfera esplosiva e dalla zona a rischio di esplosione indicata. Inoltre, prima di allacciare l'alimentatore alla tensione di alimentazione assicurarsi che questa corrisponda al valore indicato sulla targhetta. A seguire collegare l'alimentatore con il connettore K5 dell'X-zone Com (vedere cap. 4.2.4).

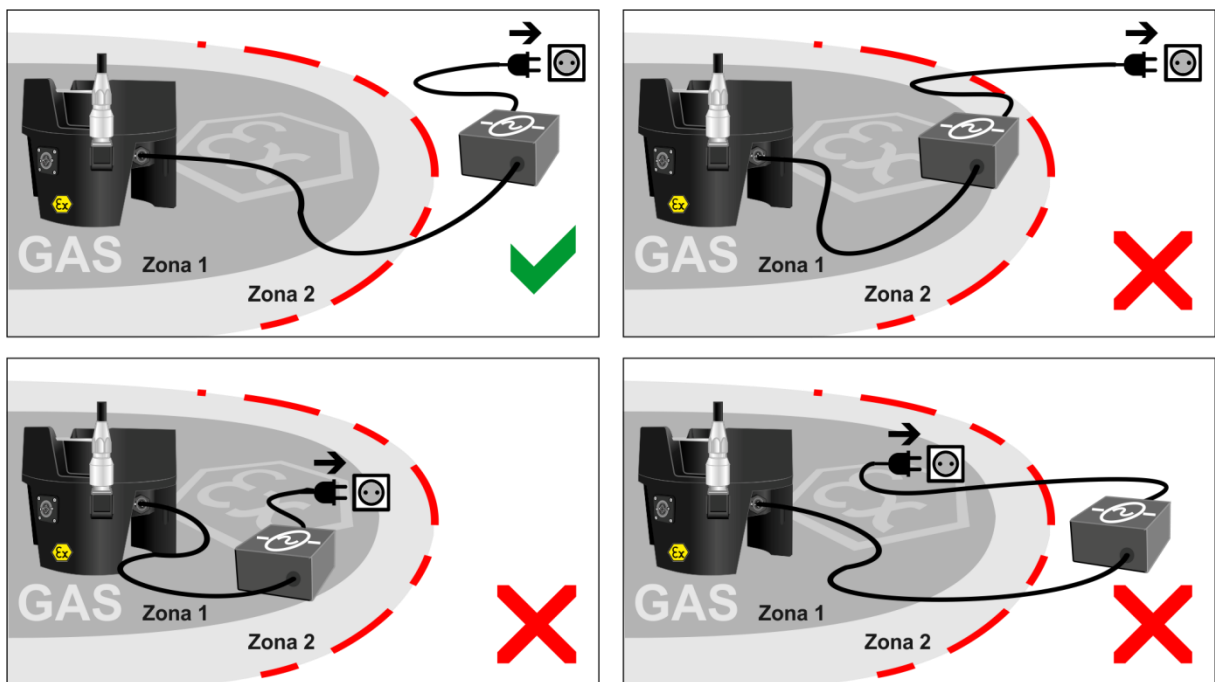

Fig. 4.3: L'allacciamento dell'alimentatore dell'X-zone Com alla tensione d'alimentazione deve sempre essere effettuato fuori dalla zona a rischio di esplosione indicata.

Durante l'operazione di carica è consigliata una temperatura ambiente tra +5°C e +30°C, diversamente può essere necessario prolungare la carica (vedere anche cap. 6.4).

### AVVISO



#### **Pericolo di esplosione!**

*Per caricare l'X-zone Com non allacciare l'alimentatore alla tensione all'interno della zona a rischio di esplosione.*

### AVVERTIMENTO



*Fare attenzione a caricare la batteria completamente a intervalli regolari (al più tardi ogni 6 mesi). Diversamente c'è il rischio di uno scaricamento completo con conseguente danneggiamento della batteria.*

*Immagazzinare l'X-zone Com spento con l'alimentatore allacciato fuori dalla zona a rischio di esplosione.*

Sul display dell'X-zone Com l'operazione di carica è visibile dal riempimento ciclico crescente della batteria (vedere cap. 6.4).



#### **Significati:**

1. Batteria scarica (l'X-zone Com si spegne).
2. Quando la batteria è collegata al caricabatterie, questo simbolo segnala il surriscaldamento della batteria e l'arresto temporaneo della carica. Appena si è abbassata la temperatura della batteria, la carica continua.



Carica batteria 100%

## 4.2.2 Inserimento della carta SIM

Per poter utilizzare l'X-zone Com per l'invio di e-mail e SMS, bisogna inserire una carta SIM nel modem interno.

Per l'utilizzo del modem GSM devono essere inserite, a cura del cliente, delle carte SIM M2M adatte alla comunicazione di dati e di SMS. Riguardo al volume di dati necessario e alla quantità di SMS necessaria, si consiglia di scegliere precedentemente con il provider i contratti più adatti. Le carte SIM che sono anche predisposte per la comunicazione verbale (ciò vale anche per le twin cards) oppure previste principalmente per l'impiego in uno smartphone, un tablet o una chiave USB/GSM, devono precedentemente essere attivate e testate in un apposito smartphone, tablet o chiave USB/GSM. In questo caso i servizi come „Inoltro di servizi di comunicazione verbale“ o simile devono essere disattivati. Soltanto dopo un'attivazione/adattamento la carta SIM può essere impiegata nel modem GSM dell'X-zone Com.

## AVVISO



### **Pericolo di esplosione!**

*Non aprire l'alloggiamento del prodotto all'interno di una zona a rischio di esplosione!*

*Inserire o rimuovere la carta SIM esclusivamente in un ambiente non a rischio di esplosione.*

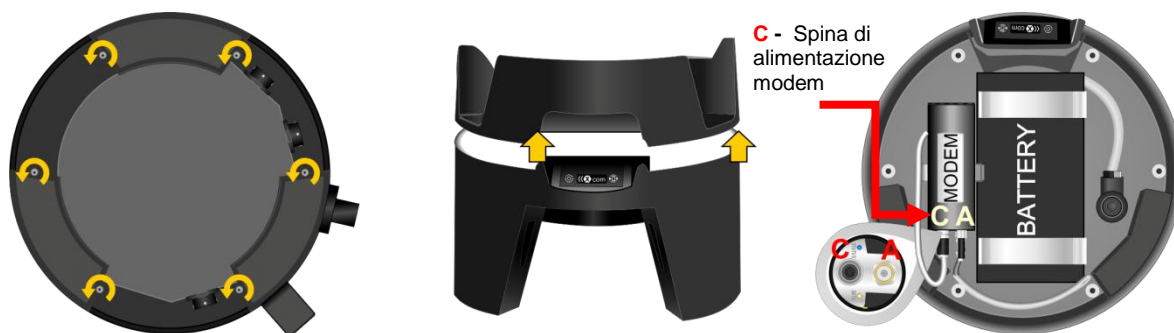

Fig. 4.4: Aprire l'alloggiamento dell'X-zone Com (C = spina di alimentazione modem, A = presa antenna).

## AVVERTIMENTO



*Prima di aprire l'alloggiamento del modem, staccare il modem dalla sua alimentazione elettrica sfilando la spina.*

Per inserire la carta SIM procedere come segue:

1. Svitare le 6 viti disposte sulla parte inferiore dell'X-zone Com.
2. Togliere con cautela la parte superiore dell'X-zone Com.
3. Scollegare il modem dall'alimentazione elettrica.
4. Staccare il modem dal gancio di sostegno.
5. Svitare il coperchio del modem (vedere Fig. 4.5).
6. Allentare il blocco del supporto carta spingendolo in direzione della freccia e poi aprendolo (vedere Fig. 4.5).
7. Inserire la carta SIM nel supporto previsto.
8. Richiudere il supporto carta e bloccarlo spingendolo nella direzione opposta.
9. Avvitare il coperchio del modem.
10. Riallacciare l'alimentazione elettrica al modem.
11. Rimettere la parte superiore (fare attenzione alla posizione corretta della guarnizione).
12. Serrare le 6 viti a mano.

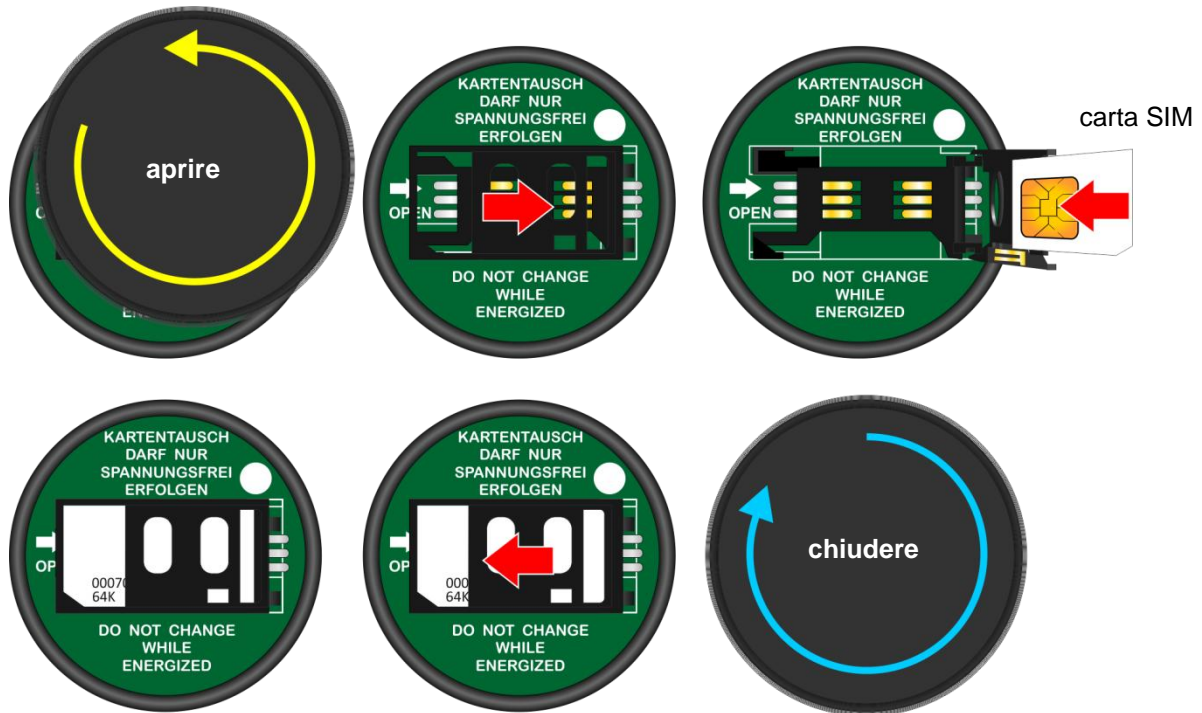

Fig. 4.5: Inserire la carta SIM. A questo scopo svitare il coperchio e spingere il supporto carta in direzione della freccia, poi aprirlo.

### 4.2.3 Montaggio/smontaggio antenna

**AVVISO**

**Pericolo di esplosione!**  
Soltanto l'antenna originale (no. ordinazione ORI: 8094108, no. ordinazione Dräger: 8324372) può essere allacciata alla presa antenna.

Per montare o smontare l'antenna non girarla con lo stelo. Per fissare l'antenna o allentarla girare soltanto il dado per raccordi, diversamente c'è il rischio che si stacchi il contatto centrale all'interno del piede dell'antenna (Fig. 4.6).



Fig. 4.6: Presa HF dell'X-zone Com

## 4.2.4 Collegamento con l'X-zone 5x00

Utilizzare il cavo RS485 contrassegnato in giallo (no. articolo 8094118) in dotazione per collegare la presa K3 dell'X-zone Com con la presa XEXT2 dell'X-zone 5x00. Fare attenzione che la spina angolare sull'X-zone Com indichi verso il basso.

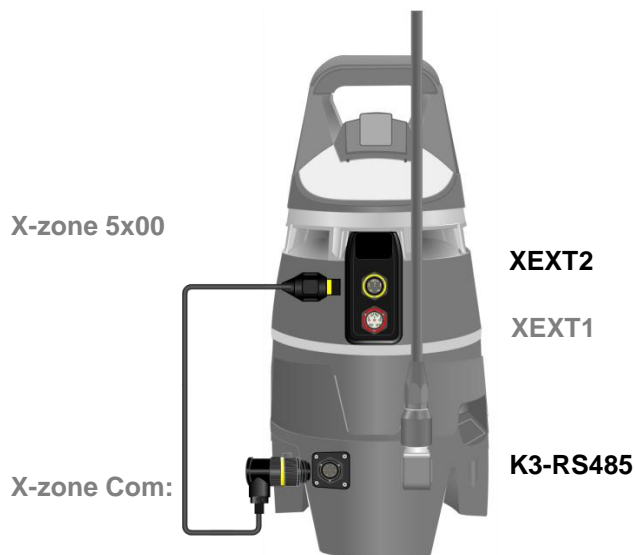

Fig. 4.7: Collegamento dell'X-zone Com all'X-zone 5x00 per mezzo del cavo RS485.

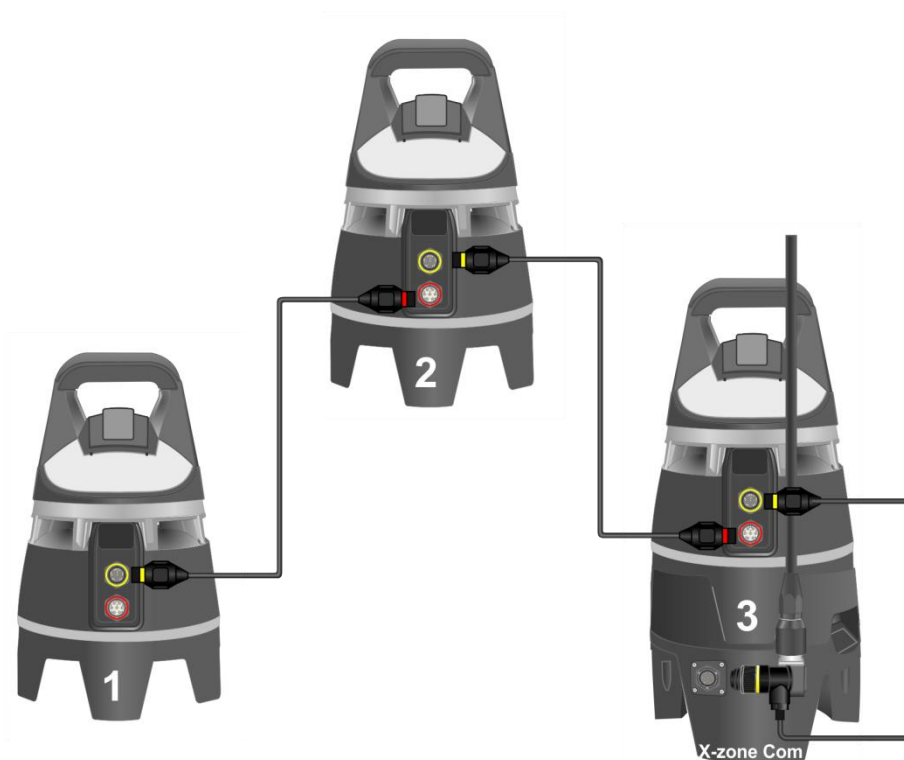

Fig. 4.8: In caso di collegamento di più dispositivi X-zone 5x00 soltanto tramite cavi di comunicazione, l'X-zone Com viene allacciata all'X-zone 5x00 sull'estremità della catena di cavi.

## AVVERTIMENTO



L'utilizzo di un X-zone Com, con l'X-zone 5x00 allacciato, richiede un firmware a partire dalla versione 2.22.

Per un aggiornamento del firmware e la configurazione del X-zone 5x00 mediante il software Dräger CC-Vision mettersi in contatto con l'incaricato dell'assistenza clienti della Dräger.

Fare attenzione che nell'X-zone 5x00 il protocollo Modbus sia attivato con l'aiuto del software Dräger CC-Vision e configurato nel modo seguente:

Impostazione del Modbus X-zone 5x00	
Connettore Modbus	XEXT2
Indirizzo Modbus	2
Baudrate	115200
Parità	Even

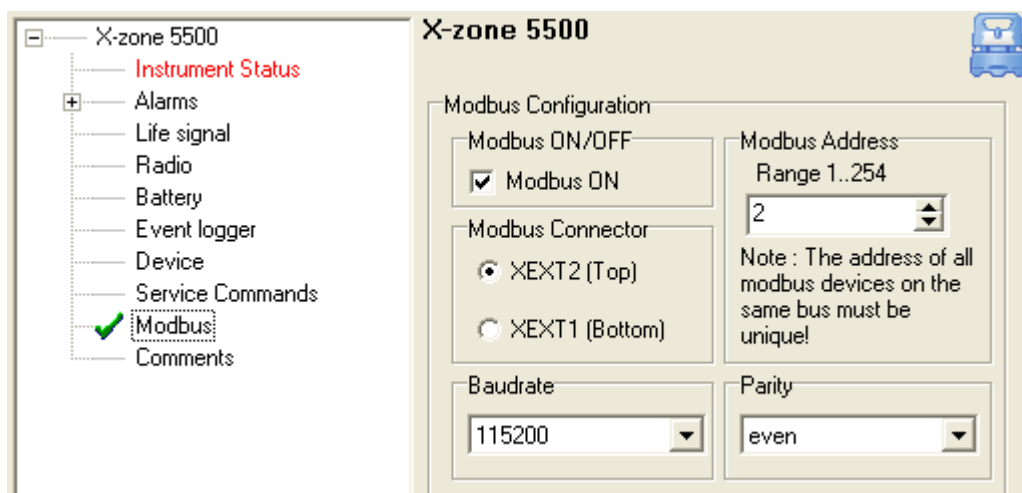

Fig. 4.9: Impostazioni Modbus all'interno del software PC Dräger CC-Vision.

### Differenza tra rete chiusa e rete aperta:

Una descrizione dettagliata delle funzionalità di rete è contenuta nelle istruzioni per l'uso dell'X-zone 5x00 di Dräger.

*“In una rete radio chiusa un dispositivo principale monitora il collegamento radio a tutti i dispositivi del gruppo e tutti questi dispositivi monitorano il collegamento al dispositivo principale. In caso di errore di un dispositivo, ad es. a causa di una batteria scarica o della rimozione di un dispositivo, sul dispositivo principale scatta l' allarme 'dispositivo'. In caso di errore del dispositivo principale su tutti i dispositivi del gruppo scatta l'allarme del dispositivo'.”*

La tabella seguente mostra il diverso trattamento da parte dell'X-zone Com. L'utilizzo del numero di serie o della stazione e dei valori misurati locali o valori massimi è valido sia per le e-mail e gli SMS inviati dall'X-zone Com che per il portale dei dati internet Mcloud e il Manager Software.

	Rete aperta	Rete chiusa (gruppo)
<b>Numero di identificazione</b>	Numero di serie	ID all'interno del gruppo (numero della stazione)
<b>Valore misurato utilizzato per un gas</b>	Valore misurato dall'X-zone 5x00 collegato	Valore massimo attuale dal gruppo
<b>Informazioni sull'allarme</b>	✓	✓
<b>Quantità massima di unità X-zone 5x00 nella rete</b>	25	15

#### AWERTIMENTO



*L'X-zone Com può essere allacciato a qualunque dispositivo X-zone 5x00 presente nella rete radio. Non è necessario allacciarlo al dispositivo principale, per esempio nella rete chiusa .*

#### AWERTIMENTO



*L'X-zone Com trasmette regolarmente un segnale all'X-zone. Se il collegamento è interrotto per più di un minuto, l'X-zone 5x00 segnala un errore del dispositivo.*

## 4.3 SCOLLEGAMENTO DALL'X-ZONE 5X00

Se il collegamento tra L'X-zone Com e l'X-zone 5x00 è interrotto per più di un minuto, l'X-zone 5x100 segnala un errore del dispositivo. Per evitare ciò, mantenere il collegamento RS485 finché l'X-zone Com non viene spento (vedere cap. 6.3). Con questa procedura si evita un errore del dispositivo.



## 5 CONFIGURAZIONE DELL'X-ZONE COM

Per configurare l'X-zone Com occorre il Manager Software la cui installazione verrà descritta in cap. 4.1.

### 5.1 CREAZIONE DI UN COLLEGAMENTO AL PC

L'X-zone Com viene collegato ad un PC o tramite una connessione wireless Bluetooth o un collegamento via cavo.

#### 5.1.1 Collegamento Bluetooth

La creazione di una connessione Bluetooth è descritta qui di seguito in modo esemplare per Windows 7. La procedura può variare leggermente in funzione del sistema operativo.

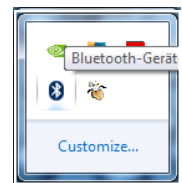

1. Assicurarsi che sul PC sia attivato il modulo Bluetooth. Nella maggioranza dei casi lo si può fare premendo i tasti funzione blu con dicitura [FN]+[simbolo di Bluetooth].
2. Assicurarsi che l'X-zone Com venga azionato con batteria completamente carica.

Se il modulo Bluetooth è attivo, cliccare con il tasto destro del mouse sul simbolo Bluetooth  nella barra degli strumenti Windows e selezionare [Add device] (Aggiungi dispositivo).

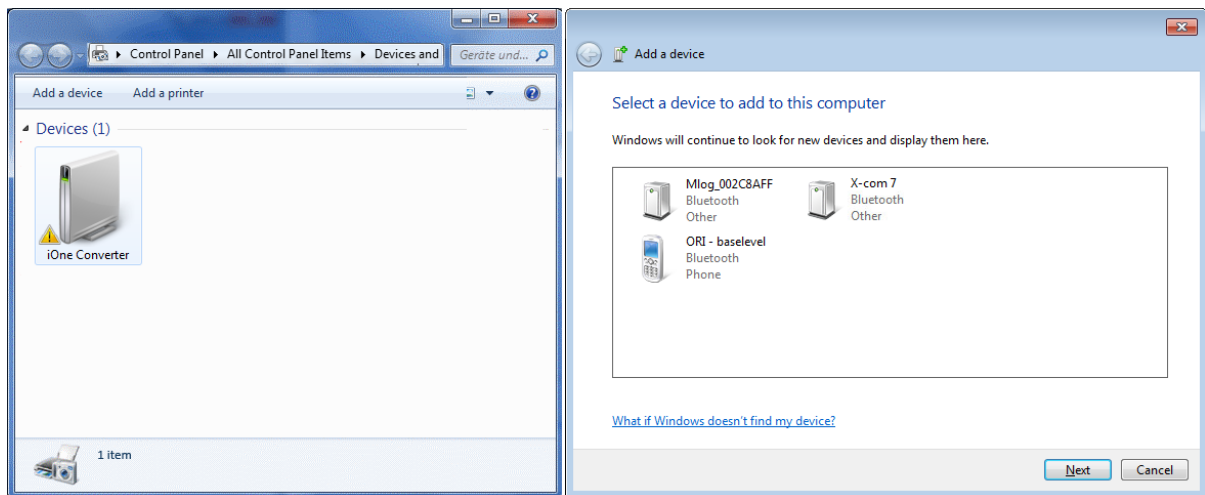

Fig. 5.1: Integrazione Bluetooth dell'X-zone Com.

Quindi selezionare il dispositivo e cliccare su [Continue] (Avanti). Se vi collegate per la prima volta con l'X-zone Com, confermare il codice di abbinamento visualizzato (in MS Windows 7). Cliccando su [Continue] l'X-zone Com viene aggiunto ai dispositivi di rete Bluetooth del PC impiegato.

Ad ogni connessione Bluetooth creata verrà assegnato da MS Windows un numero della porta COM. Per visualizzare il numero, evidenziare il dispositivo e fare clic su [Properties] (Proprietà). Quindi selezionare il modulo [Services] (Servizi) (vedere Fig. 5.2).

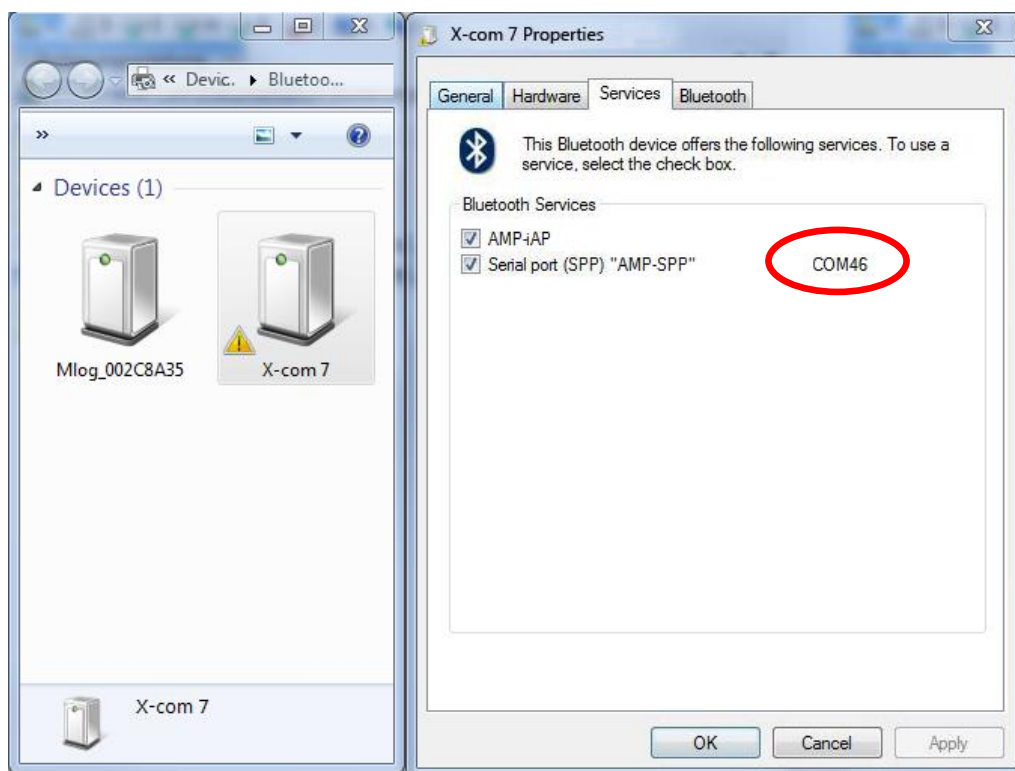

Fig. 5.2: Porta COM assegnata in MS Windows 7.

Il Manager Software è in grado di individuare la porta COM automaticamente; per creare una connessione più veloce, la porta COM può essere impostata manualmente nel Manager Software.

### 5.1.2 Collegamento via cavo

In alternativa alla connessione Bluetooth l'X-zone Com può essere collegato ad un PC tramite l'interfaccia K2 (RS232) con il cavo in dotazione. Per questo tipo di collegamento sul PC normalmente occorre un adattatore USB seriale.

Anche in questo caso il numero della porta COM assegnato da MS Windows deve essere utilizzato dal Manager Software (impostato automaticamente o manualmente).

## 5.2 VISIONE GENERALE/FINESTRA DI AVVIO

La finestra principale del Manager Software presenta cinque aree funzionali descritte qui di seguito.

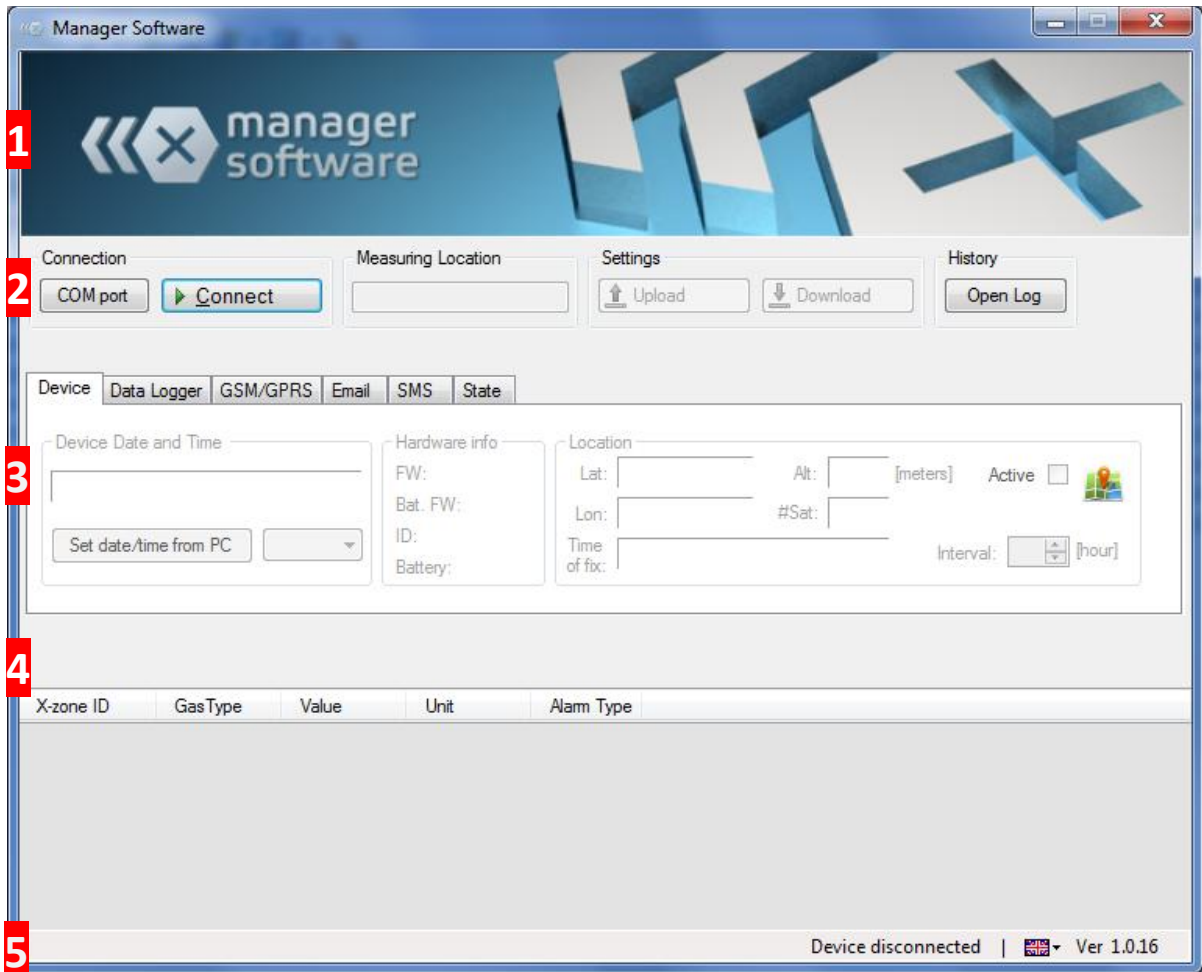

Fig. 5.3: Finestra d'avvio del Manager Software

<b>1</b>	<p><b>Logo</b></p> <p>Il logo è collegato alla Homepage di ORI (<a href="http://www.origmbh.de/">http://www.origmbh.de/</a>) (occorre l'accesso in Internet).</p>
<b>2</b>	<p><b>Informazioni sui collegamenti</b></p> <p><b>Collegamento:</b></p> <p>[COM Port] (Porta COM): Selezione di una porta COM.          [Connect]: (Connetti) crea un collegamento tra il PC e l'X-zone Com.          [Disconnect]: (Sconnetti) termina il collegamento.</p> <p><b>Nome dispositivo:</b></p> <p>Nome dell'X-zone Com definito dall'utente.</p> <p><b>Impostazioni:</b></p> <p>[Upload]: (Salvare) Accetta le impostazioni dell'X-zone Com. Scarico          [Download]: (Scarico) legge e visualizza le impostazioni correnti del dispositivo.</p> <p><b>Storico dati:</b></p> <p>[Open Log ] (Visualizza) carica i file dati BSH per visualizzare i dati. Funzione di esportazione.</p>

3	<p><b>Area configurazione</b></p> <p>Effettuare le impostazioni per i dispositivi, logger dati e comunicazione. Sono inoltre visibili varie informazioni come l'ID e lo stato del dispositivo e lo stato di carica della batteria.</p>
4	<p><b>Area valori misurati:</b></p> <p>In una rete aperta sono visualizzati i valori attuali misurati dall'X-zone 5x00 collegato localmente. In caso di allarme sono inoltre visualizzati i valori d'allarme del dispositivo che fa scattare l'allarme.</p> <p>In una rete chiusa sono visualizzati i valori attuali massimi e d'allarme provenienti da un gruppo.</p>
5	<p><b>Barra stato</b></p> <p>Visualizza lo stato di collegamento all'X-zone Com.</p> <p>Può inoltre essere selezionata la lingua del Manager Software e visualizzata la versione del Manager Software.</p>

## 5.3 INFORMAZIONI SUI COLLEGAMENTI

### 5.3.1 Creazione di un collegamento all'X-zone Com

Un collegamento tra il PC e l'X-zone Com può avvenire o mediante il cavo RS232 o via Bluetooth. Se il collegamento avviene mediante il cavo RS232, normalmente viene assegnata la porta COM.

**AVVERTIMENTO**



*Per una connessione Bluetooth funzionante, il modem Bluetooth del PC deve essere attivo e al dispositivo deve essere stata assegnata una porta Com virtuale dal sistema operativo. Per dettagli consultare il cap. 5.1*

Il Manager Software può cercare automaticamente la porta COM per la connessione seriale Bluetooth oppure è possibile assegnare manualmente la porta COM.

#### 5.3.1.1 Ricerca automatica

Dopo l'installazione del software, la ricerca automatica della porta COM è l'impostazione standard. Deve essere inserito il segno di spunto in [AutoDetect] (Ricerca automatica), come illustrato in Fig. 5.5.

Fare clic su [Connect] (Connetti) per avviare la creazione del collegamento. Sulla barra di stato appare la scritta „Searching device at:“ (Ricerca dispositivo attivata) e l'informazione su quale porta COM viene cercato il dispositivo.

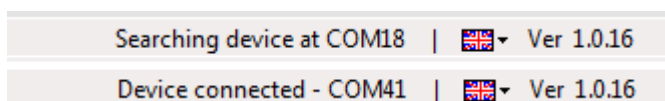



Fig. 5.4: Barra di stato del Manager Software ad avvenuta realizzazione del collegamento.

### 5.3.1.2 Selezione porta COM manuale

**AVVERTIMENTO**

 Una selezione manuale della porta COM è sempre utile quando si possiedono più X-zone Com, perché altrimenti verrà sempre creato il collegamento con l'X-zone Com trovato per primo.

Per la selezione manuale del numero della porta COM assegnato dal sistema operativo fare clic sul pulsante [COM port] (porta COM). Si apre la finestra raffigurata sotto "COM Port". Rimuovere il segno di spunto nella casella [AutoDetect] e selezionare quindi dalla lista il numero della porta COM assegnato dal sistema operativo per l'X-zone Com.



Fig. 5.5: Selezione manuale della porta COM virtuale dell'interfaccia Bluetooth o seriale.

### 5.3.2 Modifica nome del dispositivo / del luogo di misura

All'X-zone Com può essere assegnato sotto "Measuring Location" (nome dispositivo) un nome definito dall'utente (ad es. il luogo di misura) (caratteri non ammessi: „§“, „°“, dieresi e „ß“). Sotto questo nome vengono visualizzati nel ORI Mcloud tutti i valori misurati trasmessi. Alla consegna il nome del dispositivo corrisponde a quello dell'ID dell'X-zone.

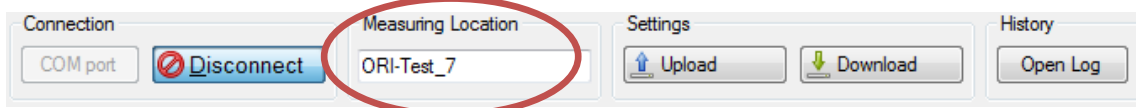



Fig. 5.6: Assegnare un nome all'X-zone Com.

Facendo clic su [Upload] (Salvare), il nome viene inserito nell'X-zone Com. Si possono inserire max. 10 caratteri per il nome. Non sono ammessi segni speciali o diacritici. Se non è stato assegnato un nome o è stato assegnato un nome non valido, non è possibile trasmettere le impostazioni nell'X-zone Com e appare un messaggio d'errore.

**AVVERTIMENTO**

 Il nome assegnato è necessario per la registrazione dell'X-zone Com nel Mcloud.

### 5.3.3 Memorizzazione e caricamento delle impostazioni dell'X-zone Com

Le impostazioni effettuate vengono scritte nell'X-zone Com selezionando [Upload] purché tutte le registrazioni siano valide. Le registrazioni non valide verranno contrassegnate in rosso e non è possibile memorizzarle.

Facendo clic su [Download] (Scarico) le impostazioni attuali vengono lette dall'X-zone Com e visualizzate dal Manager Software.

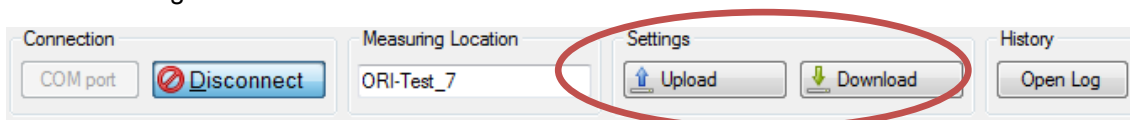

Fig. 5.7: Trasmissione o lettura delle impostazioni nell'X-zone Com.

### 5.3.4 Visualizzazione dello storico dati

**AVVERTIMENTO**

Per poter utilizzare lo storico dati nel Manager Software non è necessario che l'utente sia collegato all'X-zone Com.

Dopo aver premuto [Open Log] (Visualizza) sotto "History" (Storico dati), compare una finestra per aprire i file dati BSH inviati via e-mail. Per selezionare un record dati di misurazione premere il pulsante [...] e selezionare il file corrispondente. Cliccando su [Laden] i dati di misurazione del file selezionato vengono visualizzati in una tabella nel modulo [Data] (Dati).

Type	Date Time	Gas Type	Value	Unit	Alam Type	X-zone ID
L	25.04.2014 07:43	O2	20,9	Vol%	OK	AREH-0008
L	25.04.2014 07:43	ch4	0	%UEG	OK	AREH-0008
L	25.04.2014 07:43	O2	20,9	Vol%	OK	AREH-0008
L	25.04.2014 07:43	ch4	0	%UEG	OK	AREH-0008
L	25.04.2014 07:43	O2	20,9	Vol%	OK	AREH-0008
L	25.04.2014 07:43	ch4	0	%UEG	OK	AREH-0008
L	25.04.2014 07:43	O2	20,9	Vol%	OK	AREH-0008
L	25.04.2014 07:43	ch4	0	%UEG	OK	AREH-0008
L	25.04.2014 07:44	O2	20,9	Vol%	OK	AREH-0008
L	25.04.2014 07:44	ch4	0	%UEG	OK	AREH-0008
L	25.04.2014 07:44	O2	20,9	Vol%	OK	AREH-0008

Fig. 5.8: Tabella dei record dati di misurazione di un file dati BSH caricato nel viewer dati.

Spiegazione di alcune colonne della tabella

Colonna	Valore	Spiegazione
Tipo	L	Valore misurato locale
	M	Valore massimo del gas del gruppo
	E	Errore
Valore		Valore gas misurato loggato

Unità	Vol%, %UEG, %LEL, %LIE, ppm, mg/m3, ppb, mbar, hPa, kPa, mg/L	Unità di misurazione
Tipo di allarme	OK	Valore misurato nel range normale
	A1	Allarme A1
	A1_Q	Allarme A1 confermato
	A2	Allarme A2
	A2_Q	Allarme A2 confermato
	Err	Errore dispositivo
	Err_Q	Errore dispositivo confermato

Per esportare i record in un file CSV premere il pulsante [Save as] (Salva come). Quindi selezionare la cartella dove si vuole memorizzare il file e decidere se i record dati devono essere aperti nel foglio elettronico installato sul PC.

Selezionare il modulo [Gerät] per vedere le informazioni, contenute nel file dati riguardanti il dispositivo, il GPS, gli allarmi e le capacità delle batterie.

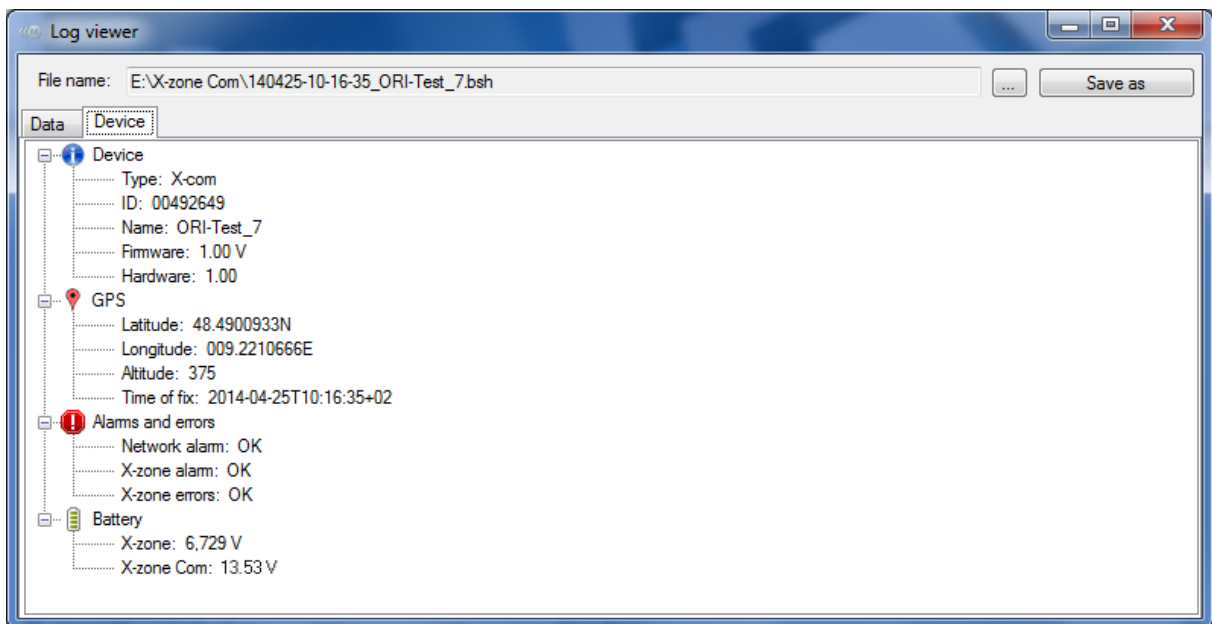

Fig. 5.9: Informazioni sull'X-zone Com nel momento della trasmissione dei file BSH nel modulo [Device] del viewer dati.



## 5.4 CONFIGURAZIONE DELL'X-ZONE COM

Nell'area di configurazione della finestra sono visualizzate le impostazioni attuali dell'X-zone Com. I singoli moduli sono spiegati qui di seguito.

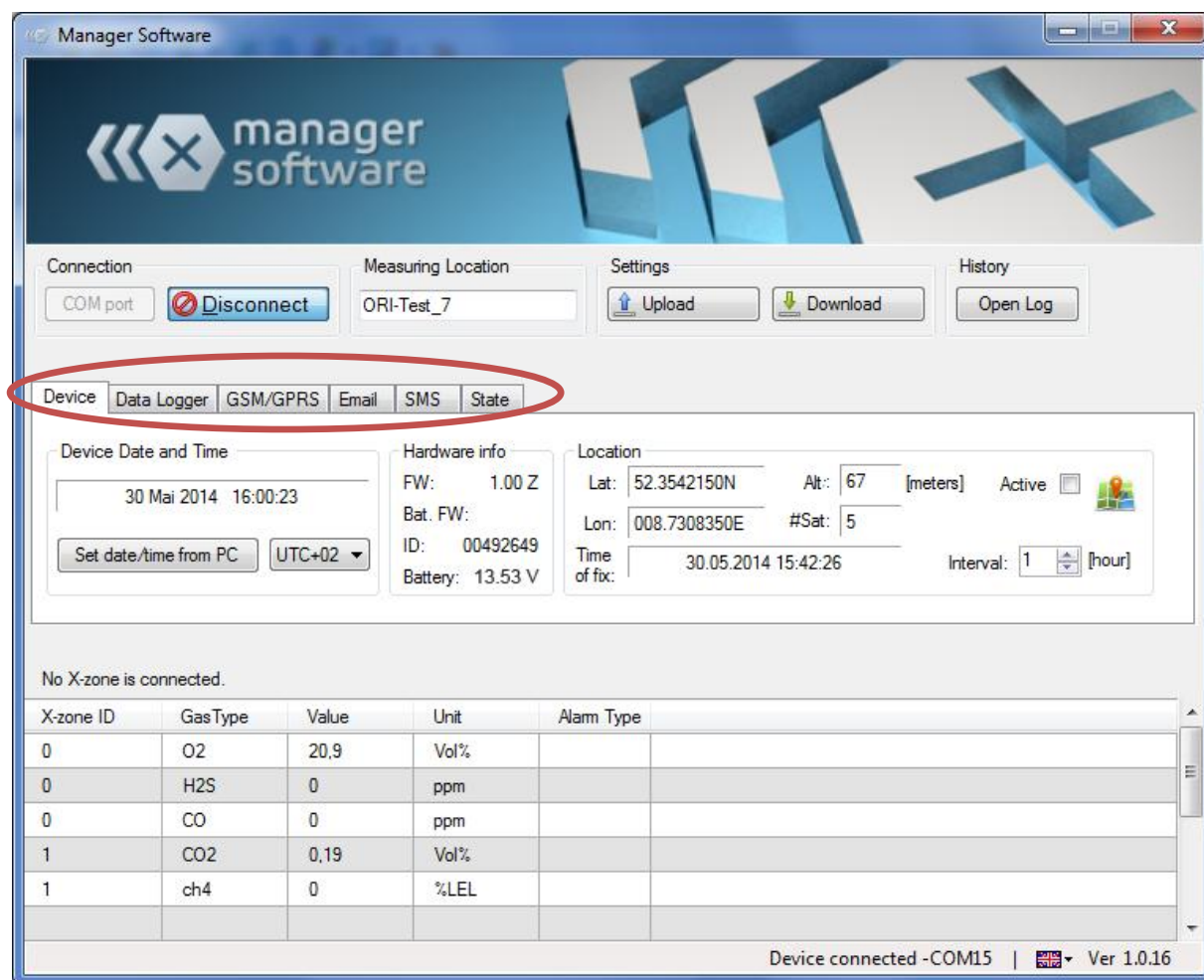

Fig. 5.10: Vari moduli per le impostazioni generali così come quelle dei logger dati, GMD, e-mail e SMS.

Ad eccezione della data e dell'ora, tutte le impostazioni effettuate devono essere trasmesse all'X-zone COM con il pulsante [Upload] (nel campo Impostazioni).



## 5.4.1 Modulo "Dispositivo"

Nel modulo "Dispositivo" possono essere visti e inseriti tutti i valori generali del dispositivo.

The screenshot shows a web interface for the 'Dispositivo' module. It has several tabs: 'Device', 'Data Logger', 'GSM/GPRS', 'Email', 'SMS', and 'State'. The 'Device' tab is active. The interface is divided into three main sections:

- Device Date and Time:** Shows '30 Mai 2014 16:00:23'. Below it are buttons for 'Set date/time from PC' and a dropdown menu set to 'UTC+02'.
- Hardware info:** Displays 'FW: 1.00 Z', 'Bat. FW:', 'ID: 00492649', and 'Battery: 13.53 V'.
- Location:** Shows 'Lat: 52.3542150N', 'Alt: 67 [meters]', 'Lon: 008.7308350E', and '#Sat: 5'. There is an 'Active' checkbox and a map icon. Below this, it shows 'Time of fix: 30.05.2014 15:42:26' and an 'Interval: 1 [hour]' dropdown menu.

Fig. 5.11: Informazioni generali sul dispositivo come per es. l'ora corrente e le coordinate GPS.

**Data/ora:** L'ora indicata è composta dall' "Universal Time Coordinated [UTC]" e dal fuso orario, ad es. nell'Europa centrale:

1. Ora legale: UTC+1
2. Ora solare: UTC+2

Facendo clic sul pulsante [PC date/time] (Data/ora del PC) la data e l'ora correnti del PC vengono scritte nel dispositivo. Ciò avviene prendendo in considerazione il fuso orario scelto (UTC+1 nell'Europa centrale). Prima però accertarsi che l'orologio del PC sia impostato correttamente.

**AVVERTIMENTO**

Appena ricevuto un segnale GPS, viene utilizzato l'orario del GPS. Con l'orologio non impostato, la memorizzazione del tempo nel record decorre dall'attivazione dell'X-zone Com, finché non si riceve l'orario GPS.

**Info:** Nel campo Info sono visualizzati il numero di versione del firmware, il numero di identificazione e lo stato di carica dell'X-zone Com in Volt.

**Location:** Nel campo "Location" (Posizione) si vedono i dati della posizione rilevati, la quantità dei satelliti GPS usati e quando è stata rilevata questa posizione. Nel campo "Interval" (Intervallo) si stabilisce in quali intervalli di tempo deve essere effettuato un nuovo rilevamento della posizione GPS, ad es. ogni ora (Fig. 5.11). Un intervallo GPS breve riduce il tempo di carica della batteria.

Cliccando sul simbolo della carta geografica, verrà visualizzata, con le coordinate presenti, la posizione del dispositivo in Google Maps. Per poterlo fare è necessario che sia installato un browser e sia disponibile una connessione Internet.

This is a close-up of the 'Location' section from the previous figure. It shows the following fields:

- Lat: 52.3542150N
- Alt: 67 [meters]
- Lon: 008.7308350E
- #Sat: 5
- Time of fix: 30.05.2014 15:42:26
- Interval: 1 [hour] (This field is circled in red in the original image)

Fig. 5.12: Intervallo in cui viene rilevata la posizione

## AWERTIMENTO



L'intervallo può essere impostato tra 0 e 24 ore. Impostando "0" il modulo GPS è permanentemente disattivato.

Con l'accensione e con l'intervallo impostato l'X-zone Com cercherà automaticamente di rilevare le coordinate GPS. Mettendo il segno di spunta nel checkbox [Active] (Attivo) inizia direttamente il rilevamento della posizione.

Location	
Lat: 52.3542150N	Alt: 67 [meters]
Lon: 008.7308350E	#Sat: 5
Time of fix: 30.05.2014 15:42:26	Interval: 1 [hour]

Fig. 5.13: Avvio di un immediato rilevamento della posizione attivando il checkbox.

Durante il rilevamento della posizione, il colore della scritta del checkbox [Aktiv] si alterna tra grigio e nero. Una volta rilevati i parametri GPS, l'alternarsi del colore si arresta e verranno visualizzati i dati della posizione. Il checkbox [Active] è attivato e viene definito il momento in cui viene fissata la posizione in "Determined on" (Rilevata il). A questo punto il sistema cerca ancora di precisare il risultato per 1 minuto. Poi il checkbox [Active] e il modulo GPS si disattivano.

Ogni tentativo fallito di rilevare una posizione verrà annullato dopo 10 minuti. In questo caso il modulo GPS si spegne per risparmiare energia. Se non è stato possibile rilevare una posizione, il sistema continua ad usare la posizione rilevata per ultima. Sul display dell'X-zone Com il simbolo GPS è depennato (vedere cap. 6.4.1).

### 5.4.2 Modulo "Logger dati"

L'X-zone Com memorizza tutti i valori misurati e gli eventi trasmessi dall'X-zone 5x00. È possibile configurare l'intervallo in cui devono essere trasmessi i valori.

## AWERTIMENTO



Tutte le impostazioni effettuate devono essere trasmesse una volta all'X-zone Com facendo clic su [Upload].

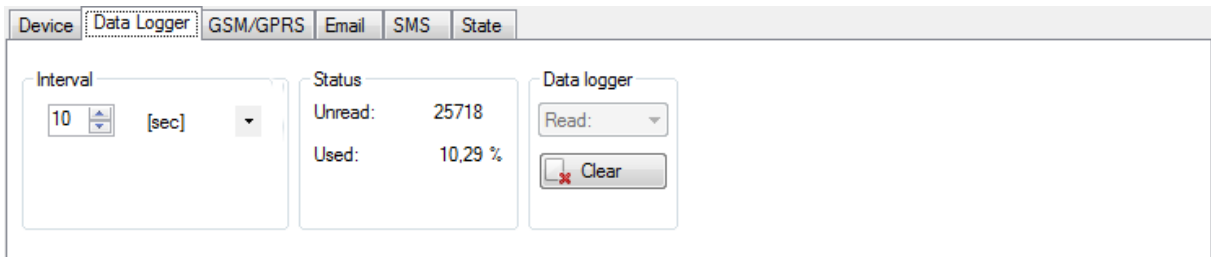

Fig. 5.14: Nel modulo "Logger dati" si stabilisce l'intervallo di logging, si possono visionare le informazioni sullo stato della memoria dati e svuotare la stessa memoria.

**Intervall:** In „Interval“ si stabilisce in quali intervalli di tempo devono essere trasmessi e salvati i valori misurati. Si possono scegliere tra secondi (10-59 sec.) o minuti (1-60 min.).

**Stato:** La quantità di record dati memorizzati è visualizzata in "Total" (Totale) e la quantità dei record non ancora trasmessi in "unread" (non letti). Viene inoltre visualizzato l'utilizzo della memoria.

**AWERTIMENTO**

*Il logger dati è realizzato come memoria ciclica, vale a dire che quando la memoria è piena, i record più vecchi vengono sovrascritti.*

**Logger dati:** [Delete] (Svuota) svuota la memoria dati del dispositivo. Prima della cancellazione definitiva viene chiesto ancora una volta conferma, per sicurezza.

### 5.4.3 Modulo "GSM/GPRS"

Per una perfetta comunicazione dati tramite la rete GSM/GPRS occorrono più impostazioni. Questi dati di connessione dipendono dal provider di telefonia mobile, al quale ci si deve rivolgere se non sono noti.

**AWERTIMENTO**

*Tutte le impostazioni effettuate devono essere trasmesse una volta all'X-zone Com facendo clic su [Upload].*

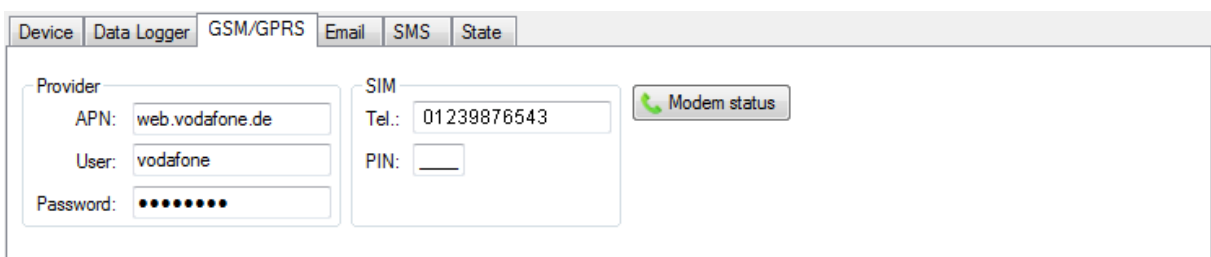

Fig. 5.15: Impostazioni telefonia mobile. Per le impostazioni valide per la carta SIM inserita consultare il relativo provider di telefonia mobile. Cliccando su [Modem status] (Stato modem) si ricevono i parametri di connessione e viene inoltre eseguito un controllo funzionale.

<b>APN</b>	Access Point Name del vostro provider di telefonia mobile da registrare all'inserimento di una nuova carta SIM.																				
	Ecco alcuni esempi per punti di accesso in Germania (senza garanzia)																				
	<table border="1"> <thead> <tr> <th>Provider</th> <th>Punti di accesso</th> <th>User</th> <th>Password</th> </tr> </thead> <tbody> <tr> <td>T-Mobile</td> <td>internet.t-mobile</td> <td>t-mobile</td> <td>tm</td> </tr> <tr> <td>Vodafone</td> <td>web.vodafone.de</td> <td>non necessario</td> <td>non necessario</td> </tr> <tr> <td>O2</td> <td>internet</td> <td>non necessario</td> <td>non necessario</td> </tr> <tr> <td>EPLUS</td> <td>internet.eplus.de</td> <td>eplus</td> <td>internet</td> </tr> </tbody> </table>	Provider	Punti di accesso	User	Password	T-Mobile	internet.t-mobile	t-mobile	tm	Vodafone	web.vodafone.de	non necessario	non necessario	O2	internet	non necessario	non necessario	EPLUS	internet.eplus.de	eplus	internet
	Provider	Punti di accesso	User	Password																	
	T-Mobile	internet.t-mobile	t-mobile	tm																	
Vodafone	web.vodafone.de	non necessario	non necessario																		
O2	internet	non necessario	non necessario																		
EPLUS	internet.eplus.de	eplus	internet																		
<b>Utente</b>	Nome utente per l'accesso in Internet																				
<b>Password</b>	La password per l'accesso in Internet																				
<b>Tel.</b>	Numero di telefono della carta SIM inserita. Input manuale																				
<b>PIN</b>	Codice PIN della carta SIM inserita nel modem, se questa dispone di una protezione via PIN. Altrimenti il campo rimane vuoto. Il PIN è necessario per attivare/avviare il dispositivo.																				

Facendo clic su [Modem Status] si apre una finestra informazioni e il modem cerca di effettuare una connessione alla rete.

Se viene visualizzato l'indirizzo IP, il controllo funzionale del modem ha dato esito positivo.

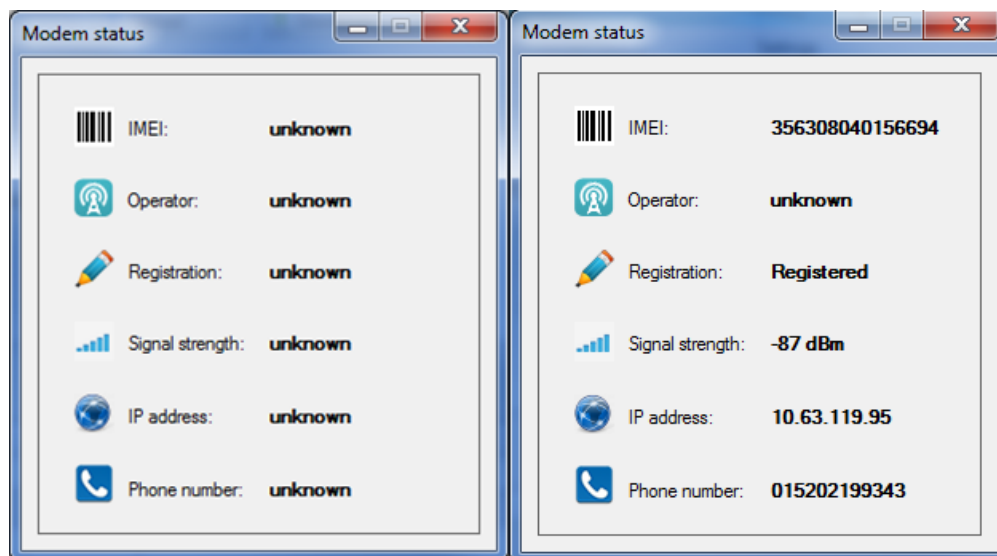



Fig. 5.16: La finestra per lo stato modem informa sui parametri di connessione.

#### 5.4.4 Modulo "Email"

L'X-zone Com invia ciclicamente le e-mail con i valori misurati; la frequenza di invio è configurabile. In caso di allarme l'invio avviene immediatamente. In entrambi i casi vengono inviati tutti i valori misurati e d'allarme non ancora trasmessi.

AWERTIMENTO



Tutte le impostazioni effettuate devono essere trasmesse una volta all'X-zone Com cliccando su [Upload].

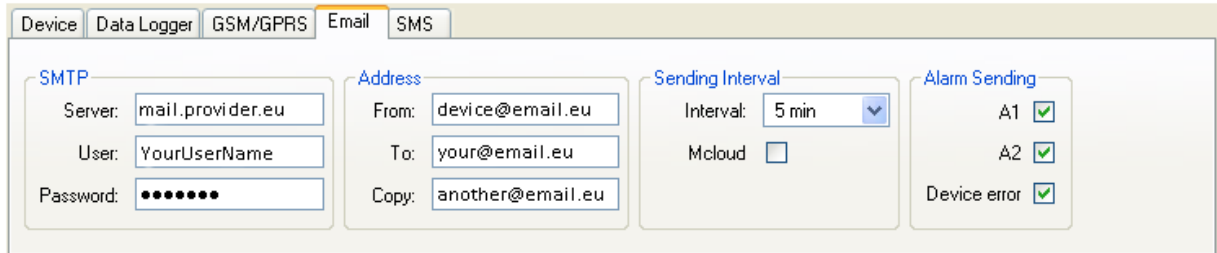

Fig. 5.17: Impostazioni per l'e-mail come il server SMTP, gli indirizzi mittente e destinatario, l'intervallo di invio e con quali allarmi deve inoltre essere inviata un'e-mail.

**SMTP:** Le impostazioni necessarie per l'invio di e-mail e l'impiego del Mcloud devono essere effettuate nel campo "SMTP".

<b>Server</b>	Indirizzo del server di posta in uscita
<b>Utente</b>	Nome utente per l'accesso alle e-mail
<b>Password</b>	Vostra password per l'accesso alle e-mail

**Indirizzo:** Gli indirizzi di mittente/destinatario sono da inserire in "Address" (Indirizzo).

<b>Da</b>	Indirizzo del mittente (definito dall'utente secondo quanto stabilito dal provider)
<b>A</b>	Indirizzo e-mail del destinatario (max. 1 destinatario)
<b>Copia</b>	Indirizzo e-mail del destinatario (max. 1 destinatario della copia)

**Sending interval:** Nel campo "Sending interval" (Intervallo d'invio) si imposta l'intervallo di tempo per gli invii (5/10/15/30 min.; 1/2/3/4/6/8/12 ore; 1 giorno). A memorizzazione avvenuta la prima e-mail viene inviata al termine dell'intervallo impostato.

Evidenziando il checkbox "Mcloud" i dati vengono trasmessi al Mcloud (vedere le istruzioni separate per l'utilizzo del Mcloud).

**Allarme invio:** Nel campo "Alarm sending" (Inviare e-mail in caso di) si può configurare in quali condizioni d'allarme deve essere attivato l'immediato invio delle e-mail e la trasmissione al Mcloud.

Controllare i dati del provider e gli indirizzi dei destinatari effettuando un controllo funzionale (vedere cap. 6.5). Con questo controllo viene subito inviata un'e-mail

## 5.4.5 Modulo "SMS"

L'X-zone Com può essere configurata in modo che in caso di allarmi vengano inviati degli SMS ai numeri di telefono definiti dall'utente. L'utente ha inoltre la possibilità di richiedere via SMS lo stato corrente e inviare istruzioni all'X-zone Com (vedere cap. 7).

**AWERTIMENTO**

Tutte le impostazioni effettuate devono essere trasmesse una volta all'X-zone Com cliccando su [Upload].

Fig. 5.18: Impostazioni per l'invio di SMS. Con queste impostazioni si stabilisce il contenuto dell'SMS in caso di un allarme. Nell'ultimo campo a destra si assegna il PIN per "Read" (Lettura) e il PIN per "Execute" (Eeguire).

Nel modulo „SMS“ si possono inserire fino a quattro destinatari di SMS da informare in caso di allarme. Per aggiungerli fare clic su [Add] (Aggiungi) e inserire il numero. Con [Remove] (Rimuovi) si rimuove il numero di telefono evidenziato. Se non è inserito nessun numero, la funzionalità SMS è disattivata. Vi è inoltre la possibilità di stabilire il numero massimo di SMS da inviare al giorno (1..99 SMS al giorno). A tale scopo si deve evidenziare il checkbox [Max. Alarm/Day] (Max. allarmi/giorno). Se il checkbox è disattivato, la quantità degli SMS da inviare è illimitata.

**Content:** Nel campo "Content" (Contenuto SMS) si può stabilire, come prefisso, una stringa (caratteri non ammessi sono: „\$“, „°“, diresi e „ß“) che appare dopo il nome del dispositivo in ogni SMS d'allarme. Oltre a ciò si può scegliere se l'SMS d'allarme deve anche contenere il valore misurato corrente e l'ID dell'X-zone 5x00 allarmante oppure soltanto il tipo d'allarme e del gas.

**Alarm sending:** Nel campo "Alarm sending" (Inviare SMS in caso di) si stabilisce in quale caso d'allarme deve essere inviato un SMS.

Tipo d'allarme	Significato
<b>A1</b>	Preallarme per concentrazione <b>Specificità:</b> in caso di tipo di gas O2 = mancanza di ossigeno
<b>A2</b>	Allarme principale per concentrazione <b>Specificità:</b> in caso di tipo di gas O2 = eccesso di ossigeno
<b>Errore dispositivo</b>	Errore sull'X-am 5x00 o X-zone 5x00. Il dispositivo o più canali dei sensori non sono pronti per l'uso. Errori segnalati dell'X-zone Com in cap. 10.1.

**AWERTIMENTO**

Per il significato esatto dei tipi d'allarme consultare le istruzioni per l'uso dell'X-am 5x00.

**PIN:** Per le richieste via SMS che l'X-zone Com deve accettare come valide, si possono assegnare due PIN. Questi PIN devono essere contenuti nell'SMS da inviare all'X-zone Com. Per azioni di pura lettura sarà contenuto il "Read" (PIN per lettura), per azioni di lettura e le azioni che vanno oltre, ad es. influire sulla situazione corrente, deve esserci il "Execute" (PIN per eseguire). L'X-zone Com reagisce soltanto agli SMS con PIN corretto e ignora tutti gli altri. Una descrizione più dettagliata dei possibili SMS si trova nel cap. 7.

Controllare i numeri di telefono inseriti effettuando un controllo funzionale (vedere cap. 6.5). Se, in almeno una delle tre condizioni d'allarme deve essere inviato un SMS, nel controllo funzionale viene subito attivato l'invio di un SMS d'allarme.

Esempio di un SMS d'allarme:

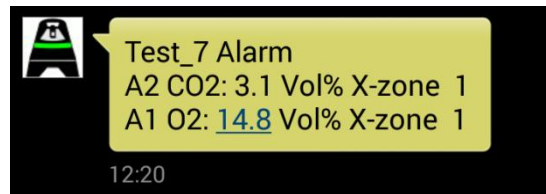



Fig. 5.19: Esempio di un SMS d'allarme inviato: L'X-zone Com "Test\_7" invia un allarme A2 per CO2 e un allarme A1 per ossigeno misurato dal dispositivo di gruppo X-zone ID 1.

**AWERTIMENTO**



Soltanto l'utente SMS che ha inviato l'interrogazione otterrà un SMS di risposta.

### 5.4.6 Modulo "Status"

Il modulo „Status“ visualizza lo stato corrente dell'hardware e le aree funzionali dell'X-zone Com collegato. Il segno di spunto verde segnala che i dispositivi e/o i sistemi sono pronti per l'uso.

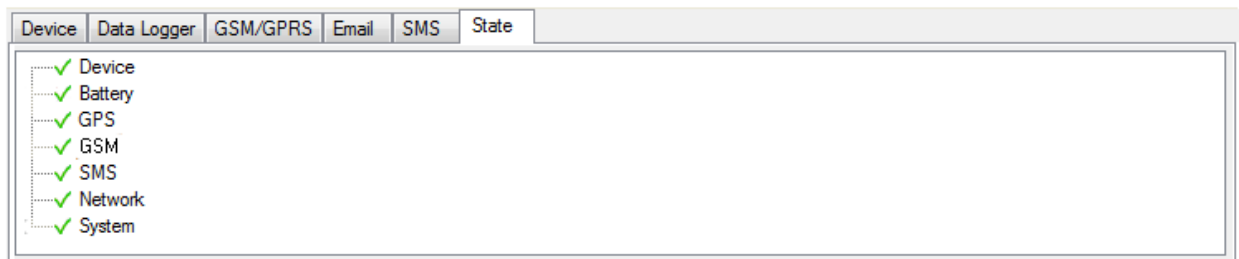

Fig. 5.20: X-zone Com è completamente pronto per l'uso

L'eventuale errore del dispositivo o disfunzione viene evidenziato da una crocetta rossa. Facendo un clic sul segno 'più' nell'albero delle directory si aprirà un messaggio più dettagliato.

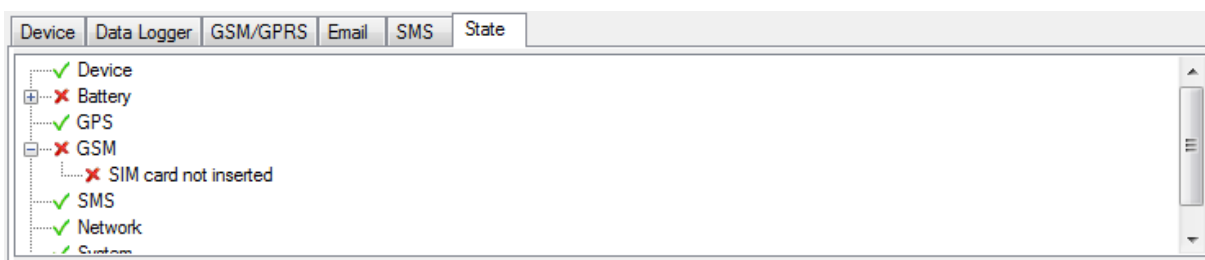

Fig. 5.21: Qui si sono presentati due errori

## 5.5 AREA VALORI MISURATI:

L'area di valori misurati visualizza i valori misurati e allarmi correnti.

Current MAXIMUM sensor values.				
X-zone ID	Gas Type	Value	Unit	Alam Type
0	O2	19,8	Vol%	A1
0	H2S	0	ppm	
0	CO	0	ppm	
0	CO2	0.25	Vol%	A2
1	ch4	0	%LEL	

Fig. 5.22: Valori misurati e allarmi nell'area valori misurati del Manager Software. Entrambi gli allarmi attivi sono stati scattati dal dispositivo 0 del gruppo.

Nella tabella sono indicati, per ogni valore misurato, il numero di identificazione dell'X-zone5x00 nel gruppo, il tipo di gas, l'attuale concentrazione di gas e l'unità nonché il tipo di allarme, se presente.

La frase sopra la tabella indica se l'X-zone 5x00 collegato fa parte di una rete aperta o chiusa (gruppo) e quindi se il valore misurato è un valore locale o un valore massimo dal gruppo (vedere cap. 4.2.4).

Titolo	Spiegazione
Valori di sensore attuali LOCALI (non configurato un gruppo chiuso)	<b>Rete aperta:</b> Vengono visualizzati i valori di sensore dell'X-zone 5x00 collegato localmente all'X-zone Com.
Valori di sensore attuali MASSIMI (il dispositivo collegato non è un master)	<b>Gruppo:</b> valori massimi dei tipi di gas attualmente misurati nella rete.
Valori di sensore attuali MASSIMI	<b>Gruppo:</b> valori massimi dei tipi di gas attualmente misurati nella rete
Non collegato con l'X-zone 5x00	Nessun collegamento all'X-zone



## 6 L'USO DELL'X-ZONE COM

In seguito viene illustrato l'uso dell'X-zone Com.

### 6.1 PANNELLO DI COMANDO

L'X-zone Com è dotato di un display OLED su cui vengono visualizzate le informazioni più importanti e di due tasti da azionare con una penna magnetica (mi sembra molto più usato).

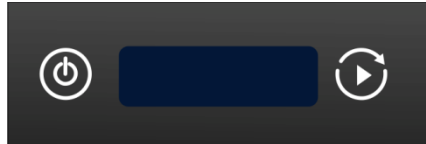

Fig. 6.1: Pannello di comando X-zone Com

I tasti hanno le seguenti funzioni:

	Tasto <b>ON/OFF</b> per attivare e disattivare il dispositivo	<b>Pressione prolungata</b> ON (ca. 3 sec.) OFF (ca. 3 sec.) <b>Breve tocco:</b> ritorno al quadro d'insieme
	Tasto <b>funzione</b>	<b>Pressione prolungata:</b> effettua il controllo funzionale <b>Breve tocco:</b> passa alla seguente videata se vi sono errori. Con un breve tocco del tasto durante un controllo funzionale, si termina il controllo.

### 6.2 ATTIVAZIONE DEL DISPOSITIVO

Per attivare l'X-zone Com premere il tasto sinistro (ON/OFF) con la penna magnetica per ca. 3 secondi. Sul display si vede il countdown a partire da 3.

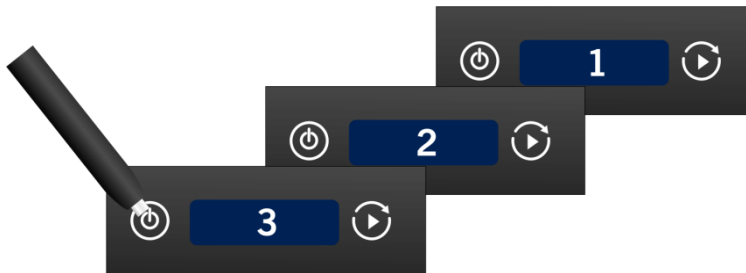

Fig. 6.2: Countdown durante l'attivazione

#### ATTENZIONE



L'X-zone Com deve esclusivamente essere usato nel range di temperature indicate.

Al momento dell'attivazione l'X-zone Com cercherà automaticamente di registrarsi e di rilevare la coordinate GPS. L'X-zone Com non si attiva se la batteria è scarica.

Se manca la carta SIM nel modem, viene generato l'errore x21 „no SIM card“.

## 6.3 DISATTIVAZIONE DEL DISPOSITIVO

Per disattivare l'X-zone Com premere il tasto sinistro (ON/OFF) con la penna magnetica per ca. 3 secondi. Sul display si vede il countdown a partire da 3.

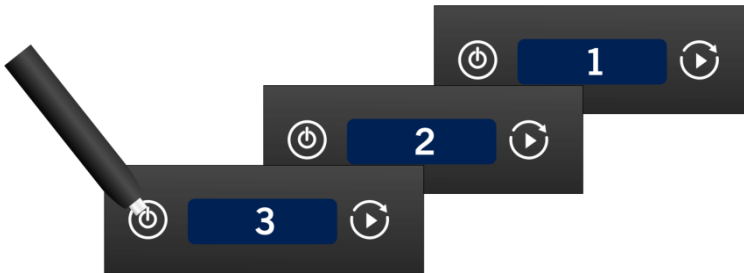

Fig. 6.3: Countdown durante la disattivazione

Se la batteria è scarica, l'X-zone Com si disattiva automaticamente.

## 6.4 VISUALIZZAZIONI SUL DISPLAY

Il display è suddiviso in due zone.

- Area a sinistra: visualizzazione dello stato per singole funzioni o azioni
- Area a destra: visualizzazione stato complessivo



Fig. 6.4: Display dell'X-zone Com



### 6.4.1 Quadro d'insieme simboli

Lo stato complessivo è descritto dai simboli seguenti:

Simbolo	Significato	Simbolo	Significato
	Attualmente non vi sono errori Tutte le azioni del controllo funzionale sono terminate con esito positivo		Stato dell'ultima azione: si è verificato un errore dell'X-zone Com
	Almeno un'azione è in corso (ad es. creazione di un collegamento, invio SMS, rilevamento posizione)		

La seguente tabella riporta il significato dei simboli per le singole funzioni.

Simbolo	Significato	Simbolo	Significato
	Trasmissione dati al ORI Mcloud attivata! <b>Lampeggiante:</b> trasmissione dati in corso.		

	Invio e-mail ad almeno un destinatario attivato <b>Lampeggiante:</b> invio e-mail in corso		L'invio e-mail e la trasmissione al Mcloud non è possibile / è stato annullato.
	SMS inviato / attivato. <b>Lampeggiante:</b> invio SMS in corso		Non è stato possibile inviare l'SMS
	Batteria completamente carica. <b>Riempimento ciclico crescente della batteria sul display:</b> carica batteria in corso.		Batteria scarica - il dispositivo si disattiverà da un momento all'altro.
	Posizione GPS rilevata <b>Lampeggiante:</b> rilevamento delle coordinate		Nessun GPS (disattivato o ricezione non possibile)
	Intensità del segnale ca. 100%		
	Intensità del segnale ca. 20% <b>Lampeggiante:</b> registrazione nella rete GSM attualmente in corso		Nessuna connessione alla rete GSM

**Esempio:**

1.		La batteria è carica al 75% ca., l'intensità del segnale è pari al 100% ca., il collegamento al Mcloud e le funzioni e-mail sono attivati, le coordinate GPS sono state rilevate. Lo stato complessivo è OK
----	---	---



## 6.4.2 Visualizzazioni di errore

Sul display possono essere visualizzati diversi errori. Al cap. 10.1. è consultabile una tabella errori. Per ogni errore la tabella riporta una descrizione e un suggerimento di intervento. Premendo il tasto destro si scorrono le visualizzazioni.



Fig. 6.5: Esempio di un errore, con numero dell'errore e breve descrizione

**Esempi:**

	Durante il controllo funzionale non sono stati inviati e-mail né SMS. In questo esempio l'invio di dati nel Mcloud non è attivato. <b>Possibili cause:</b> <ul style="list-style-type: none"> <li>• Numero di telefono non valido</li> <li>• Indirizzo e-mail errato in "a" e "copia a"</li> </ul>
	
	

## 6.5 EFFETTUAZIONE DEL CONTROLLO FUNZIONALE

Il controllo funzionale serve per verificare le impostazioni per l'invio e il ricevimento e la funzionalità dell'X-zone Com nonché la ricezione GSM e GPS. Viene inoltre subito iniziato un rilevamento posizione.

Il controllo funzionale viene attivato premendo (per 3 sec.) il tasto destro  dell'X-zone Com. A questo punto vengono eseguite le seguenti azioni:

- Attivazione GPS, rilevamento coordinate e l'ora.
- Registrazione del modem nella rete radio, impostazione accesso APN, rilevamento indirizzo IP .
- Invio dell'e-mail con tutti i dati trasmessi fino a quel momento ai destinatari registrati.
- Trasmissione nel Mcloud, se attivata la funzione Mcloud, di tutti i dati non inviati fino a quel momento.
- Invio di un SMS a tutti i numeri di telefono registrati se ne è previsto l'invio in caso di almeno una condizione d'allarme.

Le informazioni sullo stato sono visualizzate nel display (invio SMS, e-mail e Cloud, rilevamento posizione). Il simbolo continua a lampeggiare finché l'azione non è ancora conclusa.

Se si verificano degli errori, nella parte destra del display appare il relativo simbolo. Per maggiori informazioni riguardo agli errori si può consultare il Manager Software al modulo "Stato" (cap.5.4.6) .



Se l'SMS e l'e-mail sono inviati e la posizione è stata rilevata, compare la raffigurazione riportata a sinistra.

Premendo il pulsante sinistro, il display passa alla schermata di stato.

### AVVERTIMENTO



*Durante il controllo funzionale, la funzione del tasto sinistro di comando dell'X-zone Com è limitata. È soltanto possibile disattivare il dispositivo.*

## 7 INVIO SMS ALL'X-ZONE COM

L'X-zone Com offre all'utente la possibilità di richiedere, via SMS, lo stato corrente e di inviare istruzioni all'X-zone Com. Per l'interrogazione via SMS deve essere utilizzata la seguente struttura:

[PIN] Comando

Per quanto attiene al [PIN] (personal identification number) da inserire, si tratta del "PIN per lettura" assegnato da voi nel Manager Software per azioni di sola lettura oppure del "PIN per eseguire" per azioni di lettura e altre azioni quali, ad. es., influire sulla situazione attuale (vedere cap.5.4.5). Il PIN esclude che gli SMS inviati da persone non autorizzate possano essere accettati dall'X-zone Com.

Se viene inserito un PIN errato, il dispositivo genera un messaggio d'errore. In questo caso non verrà inviato un SMS di risposta.



Fig. 7.1: Messaggio d'errore sul dispositivo in caso di un PIN di SMS errato.

Il comando può essere scritto con lettere maiuscole o minuscole. È ammesso un 'punto interrogativo' seguente il comando.

Le risposte SMS sono spiegate dettagliatamente nelle sezioni seguenti.

PIN	Comando	Risposta
<b>[PIN per lettura]</b>	Stat	informazioni sul dispositivo
	Gruppo	informazioni sul gruppo
	Local	valori misurati locali dell'X-zone 5x00 direttamente collegato all'X-zone Com
	Max	valori massimi dei gas misurati nella rete chiusa
	Alarm	valori d'allarme correnti
<b>[PIN per eseguire]</b>	Ack	accettazione allarme
	Evac	allarme di evacuazione ON
	Evac off	allarme di evacuazione OFF
	GPS	le ultime coordinate GPS note

### 7.1 COMANDI SMS DI LETTURA

I comandi SMS di lettura possono essere trasmessi con il "PIN per lettura" o anche con il "PIN per eseguire".

## 7.1.1 interrogazione di stato

### [PIN] stat

Contenuto dell'SMS di risposta	Area valori
Nome dell'X-zone Com	stringa ASCII definita dall'utente
Stato di connessione all'X-zone 5x00	"X-zone connected" (X-zone connesso) "X-zone not connected" (X-zone non connesso)
GSM RSSI level [-dBm]	-100 a 0
Tensione batteria [V] dell'X-zone Com	12 - 13,5 V (max. 15V)
Tensione batteria [V] dell'X-zone 5x00	5 - 7 V
Utilizzo dell'allarme via e-mail	ON/OFF
Intervallo d'invio impostato per le e-mail e per la trasmissione dei dati nel Mcloud	5/10/15/30 min.; 1/2/3/4/6/8/12 ore; 1 giorno

### Esempio:

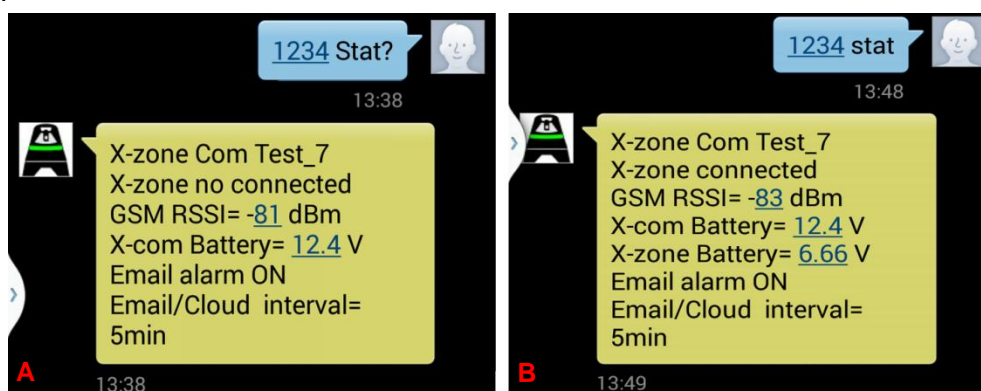

Fig. 7.2: Schermata di uno smartphone all'interrogazione avvenuta dello stato via SMS

**A)** Risposta in caso di connessione mancante verso l'X-zone 5x00

**B)** Risposta in caso di connessione esistente verso l'X-zone 5x00

Sono ammesse diciture differenti del comando.

## 7.1.2 Richiesta di informazioni sullo stato del gruppo

Con il comando "Gruppe" si possono richiedere delle informazioni sul gruppo dei dispositivi o su un dispositivo non in gruppo in una rete aperta.

### [PIN] gruppo

Contenuto dell'SMS di risposta	Area valori
Nome dell'X-zone Com	stringa ASCII definita dall'utente
Stato di gruppo del dispositivo	„dispositivo principale“ „dispositivo del gruppo“ „senza gruppo“
Entità del gruppo se connesso al dispositivo principale	da 2 a 15
Stato allarme	nessun allarme, A1, A2, errore dispositivo
Numero di gas monitorati (dal gruppo o dall'X-zone 5x00 localmente connesso)	da 0 a 8

### Esempio: Risposta in caso di gruppo

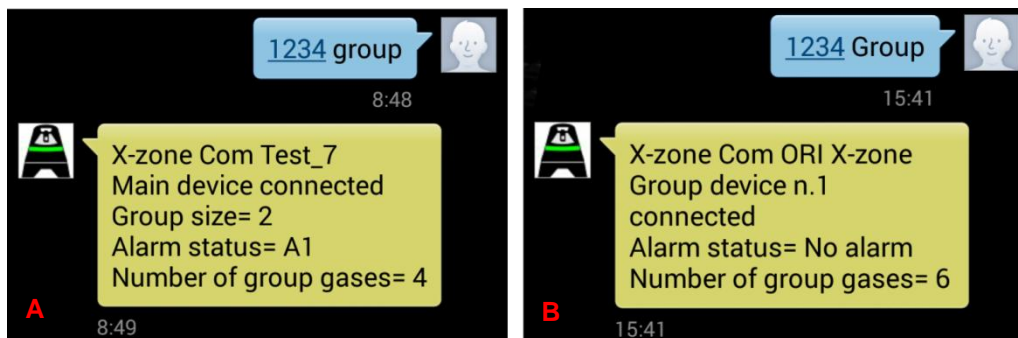

Fig. 7.3: Schermata di uno smartphone alla richiesta dello stato di gruppo via SMS

**A)** Il dispositivo che risponde è quello principale (ID=0). Il gruppo è composto da 2 dispositivi e monitora 4 tipi di gas. È presente un allarme A1.

**B)** L'X-zone Com è collegato al dispositivo di gruppo con l'ID 1. Dal gruppo vengono monitorati in tutto 6 gas. Nessun allarme presente..

### Esempio: Risposta da un dispositivo locale.

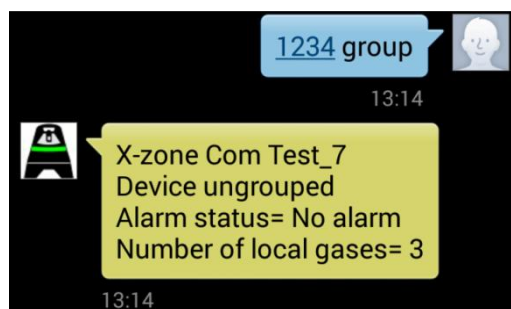

Fig. 7.4: Il dispositivo che risponde è locale, senza gruppo previsto per monitorare in tutto 3 tipi di gas.

### 7.1.3 Valori misurati dell'X-zone 5x00 collegato localmente.

Nell'interrogazione "Local" via SMS vengono trasmessi i valori attuali misurati nell'X-zone 5x00 direttamente collegato all'X-zone Com, indipendentemente da fatto che il primo faccia parte del gruppo o no.

#### [PIN] local

Contenuto dell'SMS di risposta	Area valori
Nome dell'X-zone Com	stringa ASCII definita dall'utente
Tipo di gas	nomi bevi del gas sull'X-am 5x00
Valore di concentrazione	da 0 a 10.000
Unità	Vol%, %UEG, %LEL, %LIE, ppm, mg/m3, ppb, mbar, hPa, kPa, mg/L
Tipo d'allarme	A1, A2
Numero di identificazione	Numero di serie dell'X-zone 5x00

Esempio:

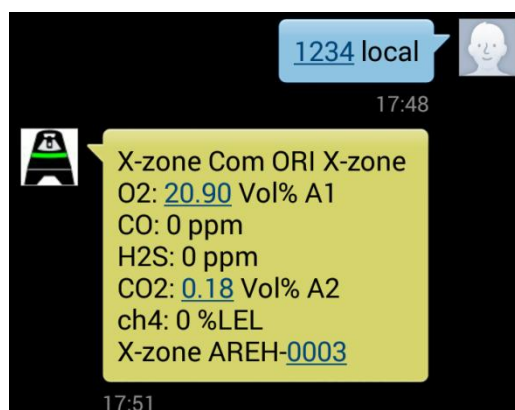

Fig. 7.5: Schermata di uno smartphone dopo l'invio di "1234 local". Nell'esempio l'X-zone "AREH-0003" collegato all'X-zone Com "ORI X-zone" misura 5 tipi di gas. Per CO<sub>2</sub> c'è un allarme A2, per O<sub>2</sub> un allarme A1.



## 7.1.4 Richiesta dei valori massimi in un gruppo

L'X-zone Com trasmette un elenco che riporta, per ogni gas misurato dal gruppo, il valore massimo attuale, nonché un tipo di allarme eventualmente presente e l'ID del dispositivo. Per l'ossigeno il valore indicato è quello minimo.

### [PIN] max

Contenuto dell'SMS di risposta	Area valori
Nome dell'X-zone Com	stringa ASCII definita dall'utente
Tipo di gas	nomi bevi del gas sull'X-am 5x00
Valore di concentrazione	da 0 a 10.000
Unità	Vol%, %UEG, %LEL, %LIE, ppm, mg/m3, ppb, mbar, hPa, kPa, mg/L
Tipo d'allarme	A1, A2
Numero d'identificazione dell'X-zone 5x00 nel gruppo, che ha misurato il valore max.	da 0 a 15

**Esempio:** Valori massimi

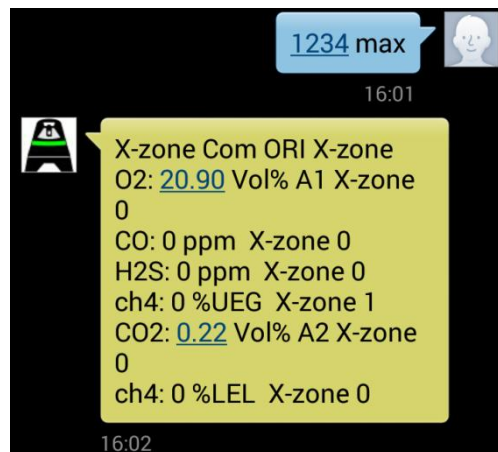

Fig. 7.6: Schermata di uno Smartphone dopo la richiesta dei valori massimi di tutti i gas monitorati dal gruppo. Nell'esempio è misurato il valore ch4 del dispositivo di gruppo con l'ID=1. Gli altri gas sono misurati dal dispositivo principale con l'ID=0. Per O<sub>2</sub> c'è un allarme A1 e per CO<sub>2</sub> un allarme A2.

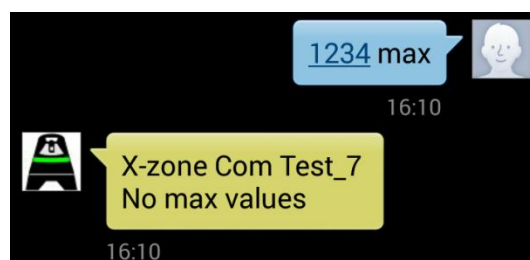

Fig. 7.7: Schermata di uno Smartphone se l'X-zone 5x00 non è un dispositivo del gruppo. In questo caso utilizzare il comando "local".

## 7.1.5 Visualizzazione delle coordinate GPS

L'SMS di risposta contiene l'ultima posizione nota dell'X-zone Com.

### [PIN] GPS

Contenuto dell'SMS di risposta	Area valori
Nome dell'X-zone Com	stringa ASCII definita dall'utente
Coordinate	grado di latitudine, grado di longitudine
Altitudine	approssimativa altitudine sul livello del mare (Mean Sea Level)
Data e ora del rilevamento di posizione con esito positivo	data e ora

L'ora indicata è composta dall'Universal Time Coordinated [UTC] e dalla differenza di fuso orario, ad es. nell'Europa centrale:

- Ora legale: UTC+1
- Ora solare: UTC+2

Esempio:

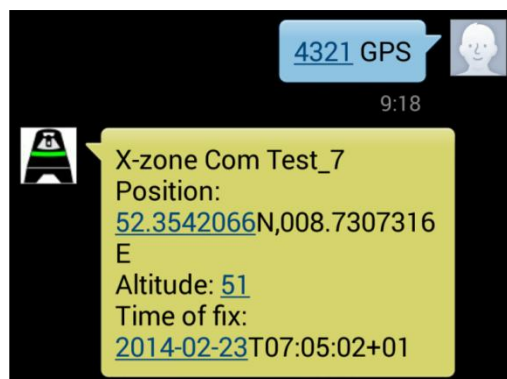

Fig. 7.8: Schermata di uno Smartphone all'interrogazione avvenuta della posizione. Nell'esempio le coordinate sono state rilevate l'ultima volta alle 08:05 ora locale (UTC+1). L'interrogazione via SMS è avvenuta alle 09:18 ora locale.

## 7.1.6 Interrogazione di allarmi attuali

Verrà inviato un elenco con gli allarmi attuali. L'elenco può contenere gli allarmi gas e gli errori del dispositivo. In caso di un allarme gas sono contenuti i seguenti dati: tipo di gas che scatta l'allarme, l'attuale valori misurato e l'unità di misura nonché su quale X-zone 5x00 è presente l'allarme. In caso di errori del dispositivo verrà trasmesso quale X-zone 5x00 ha un errore, ma non il codice errore.

La struttura della risposta SMS dipende dalle impostazioni effettuate nel Manager Software.

Fig. 7.9: Determinazione della struttura SMS di risposta all'interno del Manager Software.

### [PIN] Allarme

#### In caso di allarme di gas (A1, A2)

Contenuto dell'SMS di risposta	Area valori
Nome dell'X-zone Com	stringa ASCII definita dall'utente
Prefisso	stringa ASCII definita dall'utente
Tipo d'allarme	A1, A2
Tipo di gas	nomi bevi del gas sull'X-am 5x00
Valore di concentrazione (opzione)	da 0 a 10.000
Unità di misura (opzione)	Vol%, %UEG, %LEL, %LIE, ppm, mg/m <sup>3</sup> , ppb, mbar, hPa, kPa, mg/L
ID dell'X-zone 5x00 (opzione)	0 - 15 oppure numero di serie dell'X-zone 5x00

#### In caso di un errore dell'X-zone 5x00

Contenuto dell'SMS di risposta	Area valori
Nome dell'X-zone Com	stringa ASCII definita dall'utente
Prefisso	stringa ASCII definita dall'utente
Tipo d'allarme	"allarme dispositivo"
ID dell'X-zone 5x00 (opzione)	0 - 15 oppure numero di serie dell'X-zone 5x00

## Esempi: Allarmi

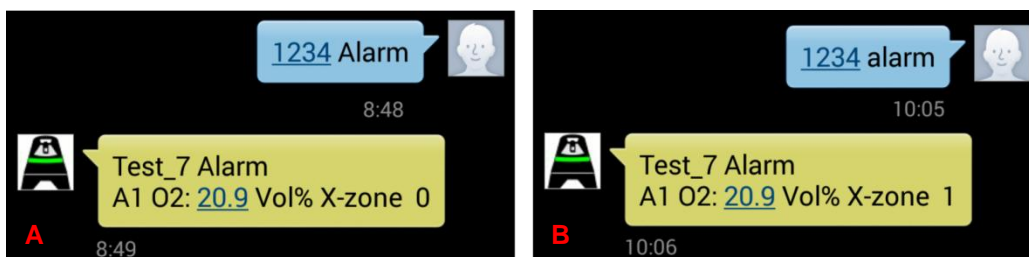

Fig. 7.10: Schermata di uno Smartphone dopo la richiesta di allarme. È stato interrogato l'X-zone Com "Test\_7". È presente un allarme A1 nell'ossigeno. Il valore dell'ossigeno indicato è il valore O2 misurato in quel momento ma non il valore che ha fatto scattare l'allarme. L'allarme è scattato in caso di:

- A. dall'X-zone 0 (0=dispositivo principale), e di
- B. dall'X-zone 1 (1=dispositivo del gruppo).

### AWERTIMENTO



In caso di allarme precedentemente confermato, con l'invio del comando 'allarme PIN' arriva il messaggio "All alarms stopped".

## 7.2 COMANDI SMS ESECUTIVI

### AWERTIMENTO



Per i comandi SMS da eseguire è necessario il "Execute PIN" impostato nel Manager Software.

### 7.2.1 Accettazione allarme

Il comportamento dell'X-am 5x00 in caso di un'accettazione allarme dipende dalla configurazione. Gli allarmi possono essere del tipo 'accettabile' o 'non accettabile' e 'ad autoconservazione' o 'non ad autoconservazione'. Pertanto, si consiglia di leggere attentamente le istruzioni per l'uso del proprio misuratore di gas Dräger X-am 5x00.

### AWERTIMENTO



L'accettazione di tutti gli allarmi non significa imperativamente che non venga più segnalato nessun allarme. Il comportamento del sistema dipende dalla situazione di allarmi e dalla configurazione dell'X-am 5x00.

La risposta SMS comprende, oltre al nome dell'X-zone Com, una conferma che gli allarmi sono stati accettati.

#### [Admin-PIN] ack

Contenuto dell'SMS di risposta	Area valori
Nome dell'X-zone Com	stringa ASCII definita dall'utente
Conferma	"allarmi accettati"

Esempio:

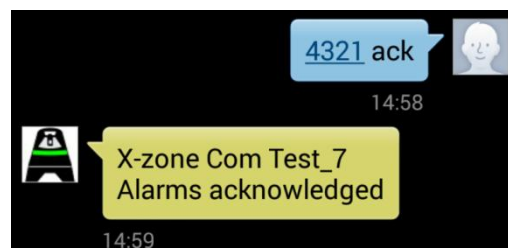

Fig. 7.11: Schermata di uno Smartphone all'invio avvenuto dell'accettazione dell'allarme.

### 7.2.2 Attivazione allarme di evacuazione

L'utente può far scattare, via SMS, un allarme che, dalla rete X-zone 5x00, viene segnalato come allarme A2. Questo è chiamato allarme di evacuazione perché normalmente serve per evacuare una zona.

#### [Execute-PIN] evac

Contenuto dell'SMS di risposta	Area valori
Nome dell'X-zone Com	stringa ASCII definita dall'utente
Conferma	"Evacuation alarm" (allarme di evacuazione)

**Esempio:**

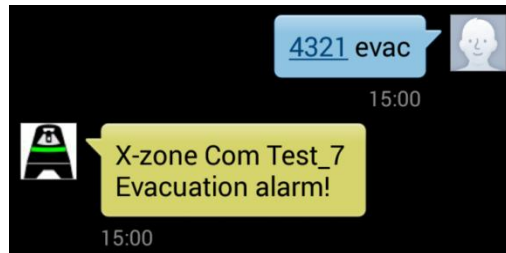



Fig. 7.12: Schermata di uno Smartphone dopo che è scattato un allarme di evacuazione.

**AVVERTIMENTO**



*In caso di un allarme di evacuazione sul display di tutti gli X-zone 5x00 del gruppo appare il simbolo di evacuazione.*

### 7.2.3 Disattivazione dell'allarme di evacuazione

L'allarme di evacuazione può essere disattivato via SMS o spegnendo l'X-zone Com.

**[Execute-PIN] evac off**

Contenuto dell'SMS di risposta	Area valori
Nome dell'X-zone Com	stringa ASCII definita dall'utente
Conferma	"Evacuation alarm stopped"

**Esempio:**

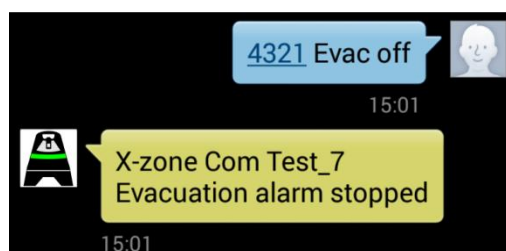

Fig. 7.13: Schermata di uno Smartphone dopo che è stato resettato l'allarme di evacuazione.

## 8 BREVE DESCRIZIONE DEL MCLLOUD

In questo capitolo sono spiegati in breve la funzionalità dell'ORI Mcloud e il suo uso. Per informazioni più dettagliate riguardo all'ORI Mcloud consultare il relativo manuale.

Il Mcloud è un portale internet dal quale si possono richiedere e visualizzare i dati del proprio X-zone Com con l'aiuto di un browser web. Oltre allo stato generale dei dispositivi, alla carica della batteria e all'ultimo momento d'invio, si vedono tutti gli andamenti dei valori di misura e i valori d'allarme. l'intervallo di tempo per le serie di misurazioni è selezionabile a scelta. I dati rappresentati graficamente possono essere esportati un file CSV e scaricati sul proprio PC dove possono essere aperti ed elaborati successivamente, ad es. in Microsoft Excel. Anche la posizione dei propri dispositivi X-zone Com può essere visualizzata in una mappa.

Per accedere al Mcloud è necessario un accesso in Internet, un browser web e - dopo 4 settimane - una licenza per ogni dispositivo. Le quattro settimane gratuite iniziano appena il dispositivo è stato registrato. Decorso questo periodo, si possono acquistare le licenze limitate nel tempo. Se la licenza di un X-zone Com è valida, non ci sono limitazioni nel numero di valori misurati che possono essere memorizzati. Prima della scadenza della licenza un simbolo d'allarme contenuto nell'elenco del dispositivo segnala tempestivamente questa circostanza.

I dati del proprio X-zone Com vengono memorizzati, in Germania, su un server collaudato dal TÜV secondo il "Trusted Site TSI V3.0 Level 1". L'accesso via browser è protetto da un password e avviene in sicurezza attraverso il protocollo di trasferimento di ipertesti HTTPS.



### 8.1 ELENCO DISPOSITIVO MCLLOUD

Nell'elenco sono riportati tutti i dispositivi registrati. Se il proprio dispositivo non è riportato, deve ancora essere registrato nel Mcloud (vedere Fig. 8.2). E' possibile effettuare la registrazione solo se il dispositivo precedentemente ha trasmesso almeno una volta. Per trasmettere dati misurati al Mcloud accertarsi di aver attivato la funzionalità di Cloud con l'aiuto del Manager Software (vedere cap.5.4.4).

The screenshot shows the 'REGISTER DEVICE' page on the Mcloud website. At the top, there is a navigation bar with the Mcloud logo, flags for USA, China, and Germany, and links for 'My account' and 'Logout'. Below the navigation bar, there is a menu with 'Home', 'List of devices', 'Map', and 'All measured values'. The main content area is titled 'REGISTER DEVICE' and contains a form with the following fields: 'Device-ID (Hex-Format)', 'Device-name (the same with location)', and a dropdown menu for 'Xcom'. A 'Register' button is located at the bottom right of the form.







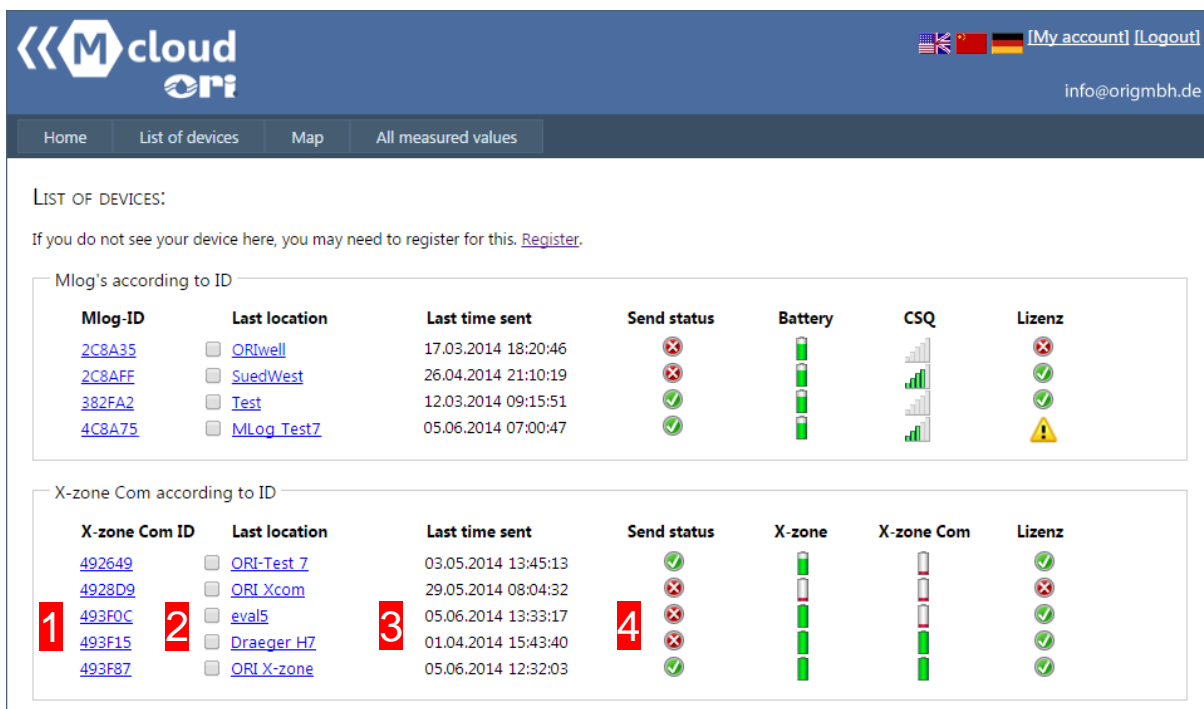



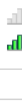





Fig. 8.1: Invito di registrazione del Mcloud di ORI.

Per ogni X-zone Com registrato si vede:

- **1** l'ID del dispositivo
- **2** l'ultimo luogo di misurazione (nome del dispositivo assegnato con l'aiuto del Manager Software)
- **3** quando il dispositivo ha trasmesso l'ultima volta
- **4** stato di trasmissione  = attualmente attivo;  = inattivo per un periodo prolungato (a partire da 24 ore)



The screenshot shows the Mcloud OPI web interface. At the top, there is a navigation bar with 'Home', 'List of devices', 'Map', and 'All measured values'. Below this, there is a section titled 'LIST OF DEVICES:' with a link to 'Register' if a device is not visible. The main content is divided into two tables:

Mlog-ID	Last location	Last time sent	Send status	Battery	CSQ	Lizenz
<a href="#">2C8A35</a>	<input type="checkbox"/> <a href="#">ORiwell</a>	17.03.2014 18:20:46				
<a href="#">2C8AFF</a>	<input type="checkbox"/> <a href="#">SuedWest</a>	26.04.2014 21:10:19				
<a href="#">382FA2</a>	<input type="checkbox"/> <a href="#">Test</a>	12.03.2014 09:15:51				
<a href="#">4C8A75</a>	<input type="checkbox"/> <a href="#">MLog_Test7</a>	05.06.2014 07:00:47				



































X-zone Com ID	Last location	Last time sent	Send status	X-zone	X-zone Com	Lizenz
<a href="#">492649</a>	<input type="checkbox"/> <a href="#">ORI-Test 7</a>	03.05.2014 13:45:13				
<a href="#">4928D9</a>	<input type="checkbox"/> <a href="#">ORI Xcom</a>	29.05.2014 08:04:32				
<b>1</b> <a href="#">493F0C</a>	<input type="checkbox"/> <b>2</b> <a href="#">eval5</a>	<b>3</b> 05.06.2014 13:33:17	<b>4</b> 			
<a href="#">493F15</a>	<input type="checkbox"/> <a href="#">Draeger H7</a>	01.04.2014 15:43:40				
<a href="#">493F87</a>	<input type="checkbox"/> <a href="#">ORI X-zone</a>	05.06.2014 12:32:03				

Fig. 8.2: Elenco di tutti i dispositivi registrati e il link alla registrazione del dispositivo.

Nelle altre colonne sono visualizzate, tramite i simboli, le informazioni supplementari inerenti ai dispositivi. In caso di un X-zone Com per es. la capacità della sua batteria o la capacità della batteria dell'X-zone 5x00 direttamente collegato.

Capacità batteria (%)	CSQ (%) intensità segnale	Stato licenza
 75 -100%	 ca. 100%	 licenza valida
 50 -75%	 ca. 80%	 licenza prossima alla scadenza
 30 -50%	 ca. 60%	 licenza scaduta
 15 -30%	 ca. 40%	
 < 15%	 ca. 20%	
	 nessun segnale	



## 8.2 STATO DEL DISPOSITIVO MCLLOUD

Facendo clic sull'ID (1) del dispositivo, vengono visualizzate informazioni più dettagliate. Qui è possibile attivare, per sicurezza, il monitoraggio dell'intervallo di trasmissione. A questo scopo inserire in "Monitoring time transmission interval" (tempo di monitoraggio dell'intervallo di trasmissione) il ciclo di trasmissione assegnato nel Manager Software (in minuti). A questo punto viene controllato se in questi intervalli il dispositivo trasmette nel Cloud. Se non succede, scatta il relativo allarme.

X-ZONE COM

Here you can see the current status and parameter values of the last episode of your X-zone Com. In addition, you can also renew the license of your X-zone here.

ORI X-zone

X-zone Com location: ORI X-zone	Created on: 07.04.2014 18:20:14	Last measured value: 05.06.2014 12:31:58	Alarm X-zone: Ok	Battery X-zone: 6,609
X-zone Com ID: 493F87 (4800391)	Last time sent: 05.06.2014 12:32:03	Local timezone: 02:00:00	Alarm Net: Ok	Battery X-zone Com: 14,136

GPS

Time: 20/05/2014 17:31:34	Time zone: 02:00:00	Longitude: 8.730717	Latitude: 52.35361	Altitude: 0
------------------------------	------------------------	------------------------	-----------------------	----------------

Parameter

Monitoring time transmission interval [min]:  Enter 0 to switch off the monitoring.

Licence

X-zone Com license expiration date:  New Licence number:

Fig. 8.3: Visualizza lo stato del dispositivo dopo che è stato cliccato sull'ID del dispositivo. Nel momento della trasmissione in Germania era in vigore l'ora solare, perciò viene indicato come fuso orario locale 02:00:00 (UTC+2 - vedere cap. 7.1.5).

In caso di allarme di intervallo trasmissione, un'e-mail informa sull'allarme e il colore del simbolo del dispositivo passa sul rosso. Se l'allarme viene confermato, il simbolo del dispositivo sulla mappa cambia da rosso a verde. Cliccando sulla voce di menu [Karte] (mappa) nella barra del menu principale, si passa nella visualizzazione della mappa.

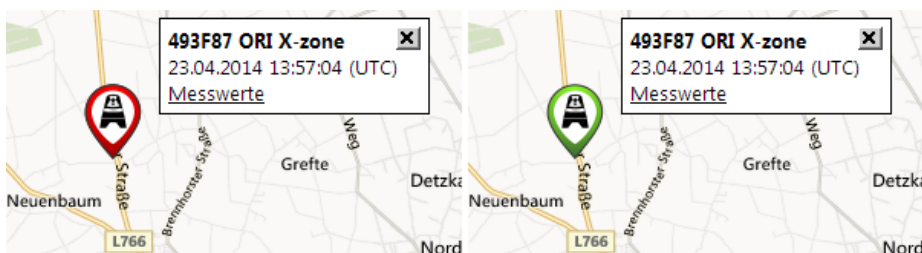

Fig. 8.4: Cambio del colore del simbolo dispositivo sulla mappa da rosso a verde dopo il ripristino di un allarme di intervallo trasmissione.

## 8.3 VALORI MISURATI M-CLOUD

Facendo clic sull'ultimo luogo di misura (2), si accede ai dati attuali misurati del dispositivo. Qui è possibile evidenziare i singoli sensori di misurazione e quindi rappresentare graficamente o esportare come file CSV i loro valori misurati per un periodo scelto.

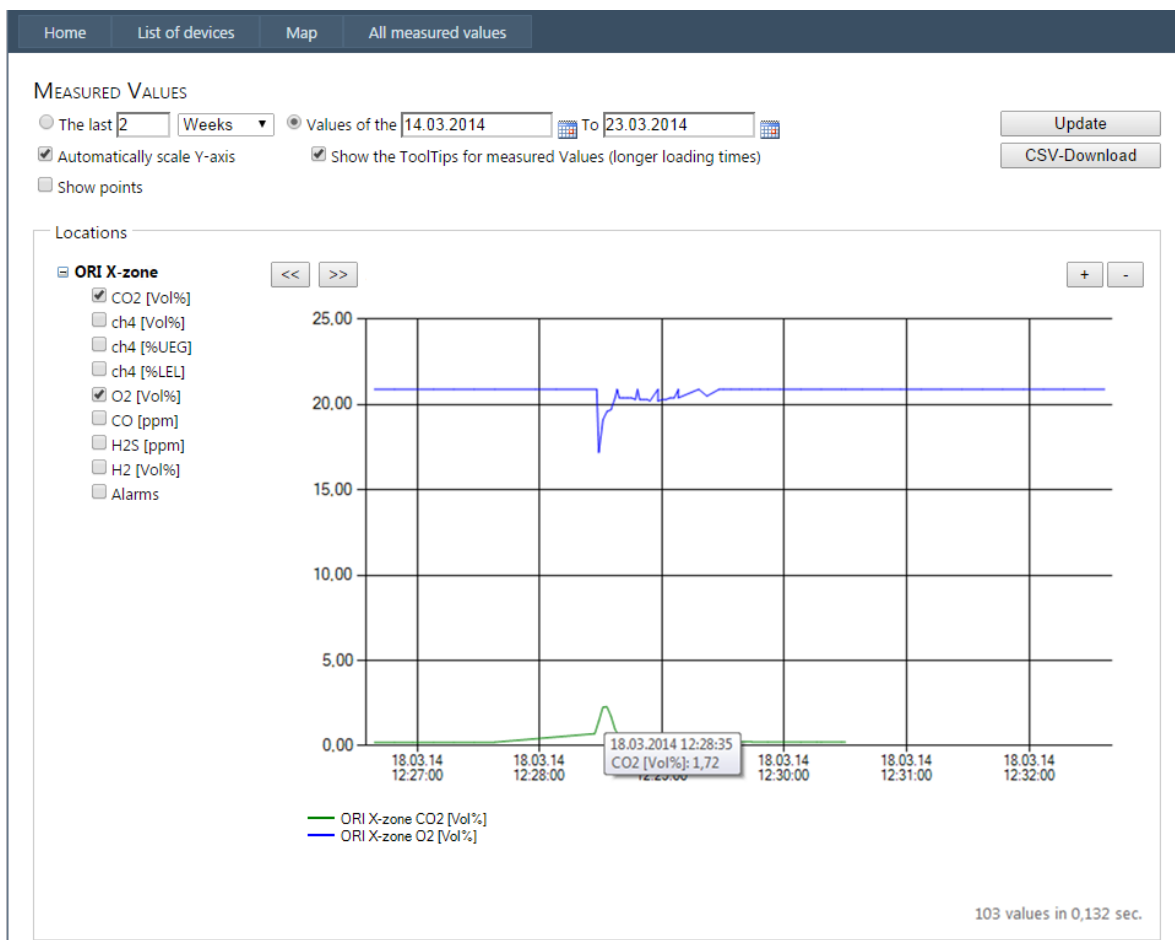

Fig. 8.5: Rappresentazione grafica zoomata dei valori misurati di due tipi di gas dall'X-zone Com Test\_7.

È possibile far visualizzare le serie di dati di più dispositivi evidenziando e cliccando sui relativi checkbox dei luoghi di misura. In alternativa è possibile fare clic su [All Measurements] (tutti i valori misurati) nella barra di menu per visualizzare tutti i dispositivi selezionabili con i relativi sensori.

### AVVERTIMENTO



È possibile la rappresentazione grafica o l'esportazione contemporanea di più serie di dati di dispositivi con ID differenti. E' anche possibile far visualizzare luoghi di misurazione differenti di un dispositivo con sensori differenti.

## 8.4 RAPPRESENTAZIONE MAPPA MCLLOUD

Cliccando su [Map] nella barra di menu principale, viene visualizzata sulla mappa la posizione di tutti i dispositivi registrati (visualizzazione selezionabile tra visualizzazione mappa, prospettiva aerea o automatica).

Visualizzazione simboli dispositivi	
 X-zone Com:	 tele camera
 Mlog	 campionatore acque reflue



Fig. 8.6: Tutti i dispositivi registrati sono indicati sulla mappa.

Muovendo il puntatore del mouse sul simbolo di un dispositivo, appare a destra del simbolo una piccola finestra con l'ID e il nome del dispositivo, l'ora dell'ultima trasmissione dati e un link ai valori misurati.

Con la rotellina del mouse o tramite la lente di ingrandimento a sinistra in alto, si può zoomare dentro o fuori nella mappa.

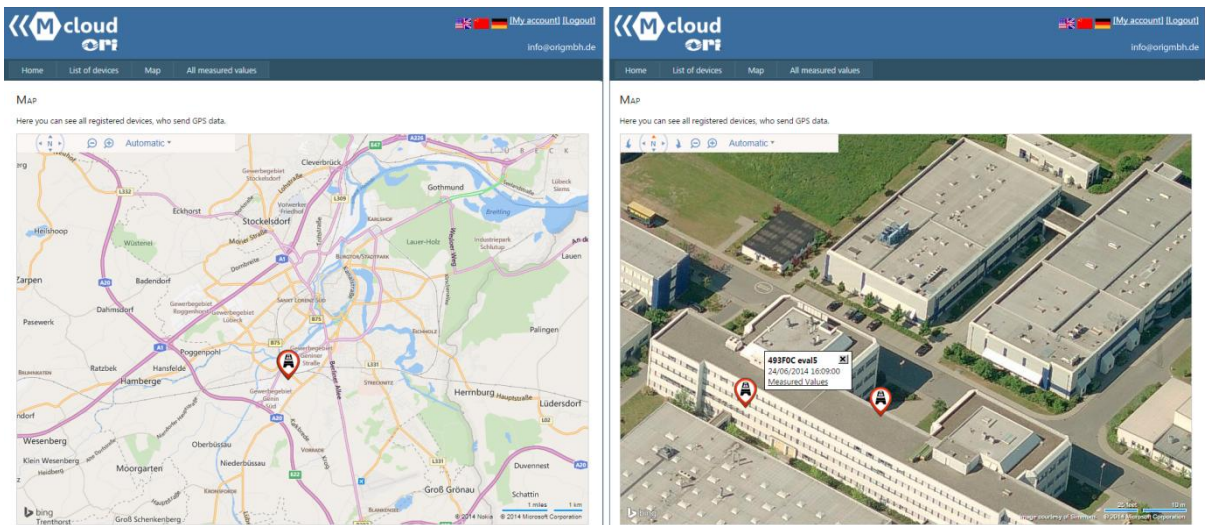

Fig. 8.7: Posizione dei dispositivi registrati nella rappresentazione mappa. Continuando a zoomare dentro, la rappresentazione cambia automaticamente nella prospettiva aerea. Dei 2 dispositivi riconoscibili in questa prospettiva uno di essi da tempo non ha più trasmesso dati nel Mcloud (simbolo rosso).

## 9 MANUTENZIONE

### 9.1 INTERVALLI

**X-zone Com:** Il dispositivo deve essere sottoposto, ad intervalli regolari, ad ispezioni e manutenzione a cura di personale esperto.

**Caricabatterie:** Il caricabatterie richiede una manutenzione speciale. L'assistenza eventualmente necessaria viene eseguita dal produttore o da una persona autorizzata dallo stesso.

### 9.2 PULIZIA

Pulire il dispositivo unicamente con un panno umido.

#### AVVERTIMENTO



**Per la pulizia non utilizzare detersivi contenenti alcool.**

### 9.3 SOSTITUZIONE DELLA BATTERIA IN CASO DI RIPARAZIONI

#### AVVISO



**Pericolo di esplosione!** Non aprire il vano batterie all'interno di una zona a rischio di esplosione. La batteria ricaricabile fa parte dell'omologazione ATEX e lo scollegamento e il collegamento della tensione di alimentazione devono essere effettuati soltanto in un ambiente non a rischio di esplosione.

#### ATTENZIONE



**Possibile danneggiamento del dispositivo!** Aprendo l'alloggiamento tenere ferma la parte superiore dell'X-zone Com per evitare che la parte superiore e la batteria cadano per terra e vengano danneggiate.



Fig. 9.1: Apertura del vano batterie

Svitare le 6 viti presenti sulla parte inferiore.

Rimuovere la parte superiore.

Staccare il connettore, allentare il gancio di sostegno, rimuovere la batteria.

Per rimontare l'X-zone Com procedere in ordine opposto. Serrare le viti a mano.



# 10 APPENDICE

## 10.1 CODICI ERRORE

Code errore	Visualizzazione sul display (X-zone Com)	Spiegazione	Rimedio
<b>Errore dispositivo</b>			
1	Check sum error	Errore del test memoria - errore di configurazione	Contattare l'assistenza di ORI.
2	Check sum error	Errore del test memoria - memoria dati	Contattare l'assistenza di ORI.
3	Internal HW error	<i>Real time clock</i> non funziona	Contattare l'assistenza di ORI.
6	Internal HW error	<i>RS485 bridge</i> non funziona	Contattare l'assistenza di ORI.
<b>Errore batteria</b>			
9	Battery HW error	Errore di comunicazione con controller batteria	Contattare l'assistenza di ORI (la batteria collegata internamente?)
10	Battery main alarm	Allarme principale batteria	Contattare l'assistenza di ORI.
11	Battery pre-alarm	Preallarme batteria	Caricare l'X-zone Com.
12	Battery empty	Batteria completamente scarica	Caricare l'X-zone Com.
14	Battery too cold	Temperatura della batteria troppo bassa	Sospendere la carica della batteria e collocare l'X-zone Com in un ambiente più caldo.
15	Charging error	Errore carica batteria	Errore carica batteria - Contattare l'assistenza di ORI.
<b>Errore GPS</b>			
16	GPS HW error	I moduli GPS non funzionano	Contattare l'assistenza di ORI.
17	GPS error	Errore GPS non specificato	Contattare l'assistenza di ORI.
<b>Errore GSM</b>			
20	GSM modem error	Il modem GSM non funziona	Il modem è collegato internamente?
21	No SIM card	Carta SIM non inserita	Inserire la carta SIM
22	SIM not working	La carta SIM non funziona	Inserire una nuova carta SIM
23	SIM: Wrong PIN	carta SIM: PIN errato	Configurare il PIN corretto con il Manager Software.
24	SIM blocked	carta SIM bloccata: è necessario inserire il PUK	Inserire la carta SIM in un telefono cellulare e sbloccare la carta digitando il PUK ( <i>Personal Unblocking Key</i> ).
25	Roaming error	<i>Roaming</i> non ammesso	Usare una carta SIM adeguata.
26	GSM error	GSM - errore sconosciuto	Configurare e controllare le impostazioni GSM/GPRS con il Manager Software (vedere cap. 5.4.3).
27	No GSM network	Rete GSM non trovata	Cambiare la posizione del dispositivo e controllare: <ul style="list-style-type: none"> <li>• l'intensità del segnale (vedere cap. 5.4.3)</li> <li>• l'antenna</li> <li>• la validità della carta SIM e il suo credito</li> </ul>
28	Wrong APN login	Errore di identificazione GPRS: indicazioni APN errati	Controllare mediante il Manager Software se sono stati correttamente inseriti: <ul style="list-style-type: none"> <li>• l'APN del provider di telefonia mobile</li> <li>• il nome utente</li> <li>• la password</li> </ul>
29	GPRS error	GPRS - errore sconosciuto	Configurare e controllare le impostazioni GSM/GPRS con l'aiuto del Manager Software (vedere cap. 5.4.3).
30	IP error	L'indirizzo IP non ricevuto	Configurare e controllare le impostazioni GSM/GPRS con l'aiuto del Manager Software (vedere cap. 5.4.3).
31	Unknown mail server	Non è possibile assegnare il <i>Mail host name</i> .	Indicare un nome del server e-mail valido.
<b>Errore SMS</b>			
40	Unknown phone no.	Numero di telefono sconosciuto	Configurare e controllare le impostazioni GSM/GPRS

			con l'aiuto del Manager Software (vedere cap. ).
41	Errore SMS	Errore SMS sconosciuto	Configurazione con l'aiuto del Manager Software.
42	SMS not sent	Non è stato possibile inviare l'SMS.	Controllare: <ul style="list-style-type: none"> <li>le impostazioni SMS con l'aiuto del Manager Software.</li> <li>in caso di carte prepagate, il credito presente</li> </ul>
43	Wrong PIN in SMS	Ricevuto un SMS con PIN errato	Impostare i "PIN lettura" e "il PIN Admin" con l'aiuto del Manager Software e utilizzarli per inviare un SMS all'X-zone Com (vedere cap. 5.4.5).
47	Unknown email user	Utente di e-mail sconosciuto	Controllare con l'aiuto del Manager Software: <ul style="list-style-type: none"> <li>il nome dell'utente</li> <li>la password</li> </ul>
48	Mailbox full	Casella e-mail piena	Controllare la casella dell'e-mail
49	Email rejected	L'e-mail è stata respinta	Controllare le impostazioni e-mail con l'aiuto del Manager Software.
50	Email not sent	Non è stato possibile inviare l'e-mail.	Controllare con l'aiuto del Manager Software: <ul style="list-style-type: none"> <li>l'intensità del segnale (vedere cap. 5.4.3)</li> <li>le impostazioni e-mail</li> </ul>
<b>Errore di sistema</b>			
85	No time set	Impostazioni dell'ora e della data non esistenti	Impostare l'ora e la data con l'aiuto del Manager Software (vedere cap. 5.4.1).
86	Incompatible SW	Modbus - errore di comunicazione con l'X-zone 5x00	Aggiornare il software dell'X-zone 5x00 e dell'X-zone Com.
89	X-zone missing	L'X-zone 5x00 è stato scollegato dall'X-zone Com.	Controllare: <ul style="list-style-type: none"> <li>il collegamento all'X-zone 5x00.</li> <li>le impostazioni del Modbus nell'X-zone 5x00</li> </ul>

## 10.2 ELENCO PER ORDINAZIONE

Spiegazione	Nr. ordinazione ORI	Nr. ordinazione Dräger
<b>Set di X-zone Com</b>  II 2G Ex ib [Ia IIC Ga] [Ib IIC] IIB T3/T4 Gb		
unità di comunicazione Dräger X-zone 5x00	8094 100	8324383
<b>Caricabatterie/alimentatore:</b>		
Caricabatterie	8094 114	8324374
cavo di rete Europa	8094 142	8325391
cavo di rete Gran Bretagna	8094 141	8325392
cavo di rete Australia	8094 140	8325393
<b>Blocco batteria</b>	8094 106	8324376
<b>Cavo di collegamento:</b>		
RS232 per il collegamento all'X-zone Com / PC	8094 120	8324379
RS 485 per il collegamento all'X-zone Com / X-zone	8094 118	8324373
<b>Software</b>		
Manager Software per la parametrizzazione dell'X-zone Com	5415 045-2	
Licenza Mcloud per 12 mesi	5415 061	8325346
Licenza Mcloud per 36 mesi	5415 063	8325347
<b>Ricambi:</b>		
Set di fissaggio (per un collegamento meccanico sicuro tra l'X-zone e l'X-zone Com attraverso una cinghia )	8094 117	
Set cinghie per il fissaggio	8094 136	8324377
Base per l'X-zone Com con supporto di fissaggio	8094 135	8324384
<b>Ricambi:</b>		
Modem GSM-GPRS	5415 029	8324375
Batteria/batteria ricaricabile	8094 106	8324376
Antenna GSM X-zone Com	8094 108	8324372

## 10.3 UPDATE DEL FIRMWARE

Per un update del firmware dell'X-zone Com è necessario che il PC e l'X-zone Com siano collegati via Bluetooth o cavo RS232, così come il software "FirmLoader.exe" e un file attuale del firmware "XCOM\_VX\_XXX.fmw". Il file è disponibile presso l'assistenza clienti competente di ORI o Dräger. Prima di procedere, rilevare il numero della porta COM del collegamento, se non è già noto (vedere cap. 5.1). Quindi procedere come segue:

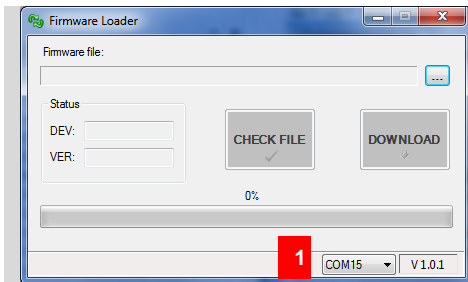

1 Avviare il file "FirmLoader.exe" e selezionare la porta COM.

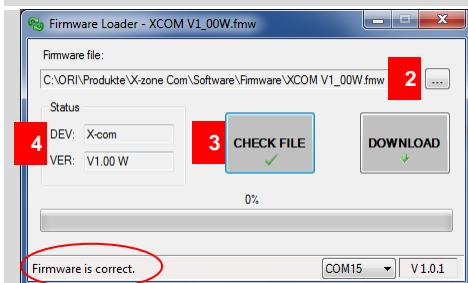

2 Selezionare l'attuale file di firmware.

3 Fare clic sul tasto [CHECK FILE] per controllare il firmware selezionato.

4 Nei campi "DEV" e "VER" sono visualizzati il modello del dispositivo e il numero della versione del firmware selezionato. Nella barra di stato in basso a sinistra appare un testo informativo.

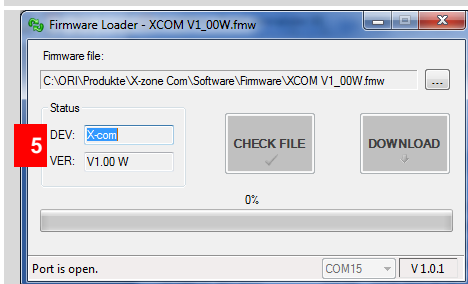

5 Controllare che si tratti di un firmware per un X-zone Com.

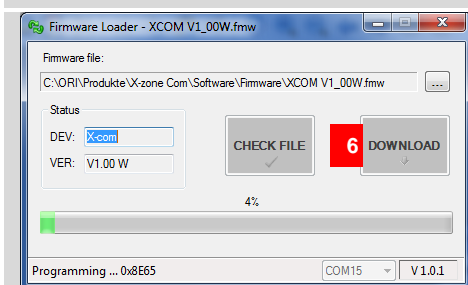

6 A questo punto fare clic su [DOWNLOAD] per installare il firmware sull'X-zone Com.

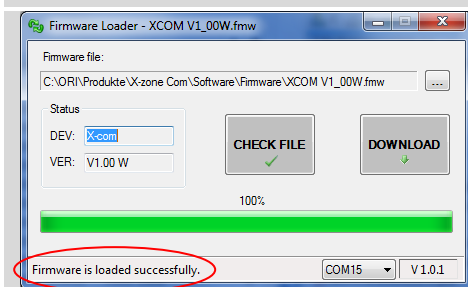

Se l'installazione del firmware ha dato esito positivo, compare una relativa indicazione sulla barra di stato in basso a sinistra.

Terminare il "Firmware Loader" facendo clic su  del menu finestra.



### AVVERTIMENTO



*In caso di un collegamento in corso con un X-zone 5X00 scatterà un allarme durante il DOWNLOAD.*

In caso di un update con esito negativo controllare tutti i collegamenti. Accertarsi che in caso di una connessione via Bluetooth il computer riconosca l'X-zone Com e che la distanza tra i due dispositivi non sia troppo grande o venga disturbata da ostacoli interposti tra i due dispositivi. Controllare il numero della porta COM.

Riavviare l'update.

## 10.4 CERTIFICATI

	<h1>IECEX Certificate of Conformity</h1>	
<b>INTERNATIONAL ELECTROTECHNICAL COMMISSION</b> <b>IEC Certification Scheme for Explosive Atmospheres</b> for rules and details of the IECEx Scheme visit <a href="http://www.iecex.com">www.iecex.com</a>		
Certificate No.:	<input type="text" value="IECEX FTZU 14.0013X"/>	issue No.: <input type="text" value="0"/>
Status:	<input type="text" value="Current"/>	
Date of Issue:	<input type="text" value="2014-06-13"/>	Page 1 of 3
Applicant:	<b>ORI-Abwassertechnik GmbH &amp; Co. KG</b> Bollacken 2, 32479 Hille Germany	
Electrical Apparatus: <i>Optional accessory:</i>	<b>Communication Equipment Device COM</b>	
Type of Protection:	<b>Intrinsic safety</b>	
Marking:	<b>Ex ib [ia IIC Ga] [ib IIC] IIB T3/T4 Gb</b>	
<i>Approved for issue on behalf of the IECEx Certification Body:</i>	Dipl. Ing. Lukáš Martinák	
<i>Position:</i>	Head of the Certification Body	
<ol style="list-style-type: none"><li>1. This certificate and schedule may only be reproduced in full.</li><li>2. This certificate is not transferable and remains the property of the issuing body.</li><li>3. The Status and authenticity of this certificate may be verified by visiting the Official IECEx Website.</li></ol>		
Certificate issued by:		



Physical Technical Testing Institute  
Ostrava – Radvanice



## EC-Type Examination Certificate

- (1)  
(2) **Equipment or Protective Systems Intended for Use  
in Potentially Explosive Atmospheres  
(Directive 94/9/EC)**

(3) EC-Type Examination Certificate Number:

**FTZÚ 14 ATEX 0048X**

- (4) Equipment or protective system: **Communication Equipment Device.COM**  
(5) Manufacturer: **ORI Abwassertechnik GmbH & Co. KG**  
(6) Address: **Bollacken 2, D-32479 Hille, Germany**  
(7) This equipment or protective system and any of acceptable variation thereto is specified in the schedule to this certificate and the documents therein referred to.  
(8) The Physical Technical Testing Institute, notified body number 1026 in accordance with Article 9 of the Council Directive 94/9/EC of 23 March 1994, certifies that this equipment or protective system has been found to comply with the Essential Health and Safety Requirements relating to the design and construction of equipment and protective systems intended for use in potentially explosive atmospheres given in Annex II to the Directive.

The examination and test results are recorded in confidential Report N°:

**14/0048 dated 13.06.2014**

- (9) Compliance with Essential Health and Safety Requirements has been assured by compliance with:  
**EN 60079-0:2012, EN 60079-11:2012, EN 60079-26:2007**  
(10) If the sign "X" is placed after the certificate number, it indicates that the equipment or protective system is subject to special conditions for safe use specified in the schedule to this certificate.  
(11) This EC-Type Examination Certificate relates only to the design, examination and testing of the specified equipment or protective system in accordance to the directive 94/9/EC. Further requirements of the Directive apply to the manufacturing process and supply of this equipment or protective system. These are not covered by this certificate.  
(12) The marking of the equipment or protective system shall include following:

 **II 2G Ex ib [ia IIC Ga] [ib IIC] IIB T3/T4 Gb**

This EC-Type Examination Certificate is valid till: **13.06.2019**

Responsible person:

  
Dipl. Ing. Lukáš Martinák  
Head of Certification Body



Date of issue: 13.06.2014

Page: 1/4

This certificate is granted subject to the general conditions of the FTZÚ, s.p.  
This certificate may only be reproduced in its entirety and without any change, schedule included.

FTZÚ, s.p., Pikartská 1337/7, 716 07 Ostrava-Radvanice, Czech Republic,  
tel +420 595 223 111, fax +420 596 232 672, ftzu@ftzu.cz, www.ftzu.cz



Physical Technical Testing Institute  
Ostrava – Radvanice



## Supplement No. 1 to EC-Type Examination Certificate

- (1)
- (2) **Equipment or Protective Systems Intended for Use  
in Potentially Explosive Atmospheres  
(Directive 94/9/EC)**

(3) EC-Type Examination Certificate Number:

**FTZÚ 14 ATEX 0048X**

(4) Equipment or protective system: **Communication Equipment Device.COM**

(5) Manufacturer: **ORI Abwassertechnik GmbH & Co. KG**

(6) Address: **Bollacken 2, D-32479 Hille, Germany**

- (7) This supplement of certificate is valid for:
- modification of certified apparatus
  - modification of apparatus marking
  - new model (variant) external power supply **02617PS**
- (8) Modification of certified apparatus (protective system) and any of its approved variants are specified in documentation, list of which is mentioned in schedule of this certificate.
- (9) This supplement to type examination certificate is valid only for type examination of design and construction of product sample in accordance with Annex 3 Paragraph 6) of Directive No. 94/9/EC. The Directive contains another requirements, which manufacturer shall fulfil before products are placed on market or introduced in service.
- (10) Safety requirements of modified parts were fulfilled by satisfying the following standards:  
**EN 60079-0:2012, EN 60079-11:2012, EN 60079-26:2007**
- (11) Marking of equipment shall contain symbols:

 **II 2G Ex ib [ia IIC Ga] [ib IIC] IIB T3/T4 Gb**

 **II (2)G [Ex ib Gb] IIB** zdroj 02617PS

(12) This type examination certificate is valid till: **13.06.2019**

Responsible person:

  
Dipl. Ing. Lukáš Martinák  
Head of Certification Body



Date of issue: 20.10.2014

Page: 1/3

This supplement to certificate is granted subject to the general conditions of the FTZÚ, s.p.  
This supplement to certificate may only be reproduced in its entirety and without any change, schedule included.

FTZÚ, s.p., Pikartská 1337/7, 716 07 Ostrava-Radvanice, Czech Republic,  
tel +420 595 223 111, fax +420 596 232 672, ftzu@ftzu.cz, www.ftzu.cz

# X-zone COM

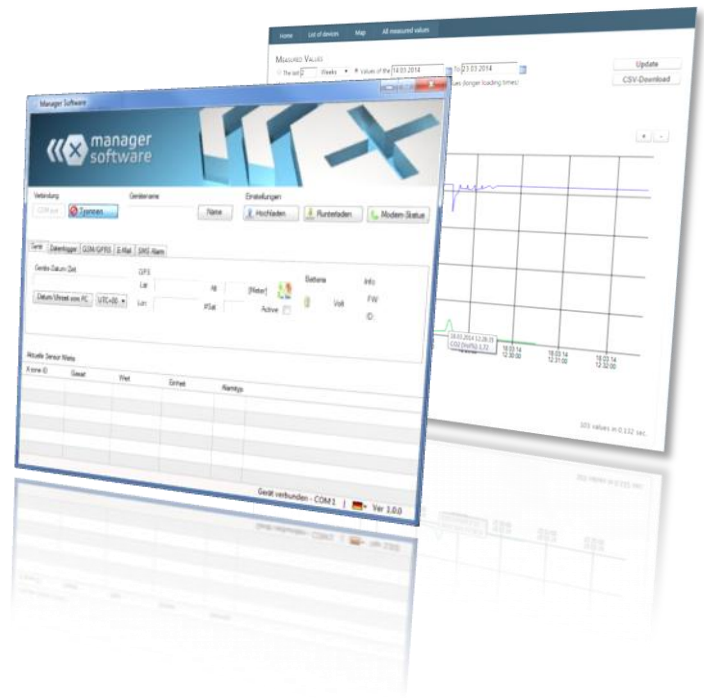

X-zone Com  II 2G Ex ib [ia IIC Ga] [ib IIC] IIB T3/T4 Gb  
Tipo: 02617

## instrucciones de servicio

Rev20141022-01

Art. núm. 8094130



---

## Traducción

Caso que en el texto traducido se den divergencias, debe consultarse el original de las instrucciones de servicio (en alemán) a fin de aclarar la cuestión o bien debe consultarse al fabricante.

## Copyright

La entrega así como la reproducción de este documento, su empleo y comunicación de su contenido están prohibidos a no ser que se autoricen expresamente. Las contravenciones obligan a indemnizar por perjuicios. Reservados todos los derechos.

## Nombres de uso

La reproducción de los nombres de uso, nombres comerciales, denominaciones de mercancía y semejantes en estas instrucciones de servicio no autoriza a emplear estos nombres sin más; frecuentemente, aunque no se haga constar esto, son señalizaciones de mercancía registradas y legalmente protegidas.

## Autorización

Este documento no substituye la documentación técnica de los certificados válidos. En caso necesario, solicite por separado esta documentación técnica a ORI GmbH & Co.KG.

## Empleo en entornos con peligrosidad de explosión

El aparato o las piezas constructivas que se empleen en entornos con peligro de explosión y se comprueben y autoricen según directrices de protección contra las explosiones de alcance nacional, europeo o internacional, solamente pueden emplearse con las condiciones indicadas en la autorización y observando las disposiciones legales relevantes. **No deben realizarse modificaciones en medios de servicio, dispositivos o piezas constructivas. El empleo de piezas defectuosas o incompletas no está autorizado.** Con motivo de las reparaciones a llevar a cabo en este dispositivo o en las piezas constructivas han de observarse las prescripciones correspondientes.

El dispositivo ha de someterse regularmente a las inspecciones y trabajos de mantenimiento, que han de correr a cargo de los técnicos especializados.



**¡Leer atentamente antes de la puesta en servicio!**

---

(introduzca aquí el número de serie de X-zone Com)

# INDICE

<b>1</b>	<b>Generalidades.....</b>	<b>5</b>
1.1	Descripción del funcionamiento.....	5
1.2	USO PRESCRITO.....	5
1.3	Almacenamiento y reenvío.....	6
1.4	Eliminación.....	6
<b>2</b>	<b>Indicaciones relativas a la seguridad.....</b>	<b>7</b>
2.1	Señalizaciones de seguridad y símbolos.....	7
2.2	Indicaciones Relativas a la seguridad.....	8
2.3	Seguridad del servicio.....	8
<b>3</b>	<b>Estructura y datos técnicos.....</b>	<b>9</b>
3.1	Dimensiones.....	9
3.1.1	X-zone Com + X-zone 5x00.....	9
3.1.2	Cargador de batería I.S. Power supply 02617PS.....	10
3.2	Interfaces del X-zone Com y del Cargador de batería.....	10
3.2.1	X-zone Com.....	10
3.2.2	Cargador de batería I.S. Power supply 02617PS.....	12
3.3	Señalización.....	13
3.4	Especificaciones del dispositivo.....	14
3.4.1	X-zone Com.....	14
3.4.2	Cargador de batería.....	15
<b>4</b>	<b>Montaje y puesta en servicio.....</b>	<b>16</b>
4.1	Instalación del Manager Software.....	16
4.1.1	Requisitos del sistema.....	16
4.1.2	Instalación de Manager Software.....	16
4.2	Primera puesta en servicio.....	18
4.2.1	Cargar el acumulador (batería).....	18
4.2.2	Colocar la tarjeta SIM.....	19
4.2.3	Montaje / desmontaje de la antena.....	21
4.2.4	Conectar con el X-zone 5x00.....	22
4.3	Separar del X-zone 5x00.....	24
<b>5</b>	<b>Configurar el X-zone com.....</b>	<b>25</b>
5.1	Crear un enlace al ordenador.....	25
5.1.1	Conexión Bluetooth.....	25
5.1.2	Conexión por cable.....	26
5.2	VISTA Sinóptica / vista inicial.....	27
5.3	Informaciones relativas a la conexión.....	28
5.3.1	Crear la conexión al X-zone Com.....	28
5.3.2	Denominación de aparato / modificar el nombre del lugar de medición.....	29
5.3.3	Memorizar y cargar los ajustes de X-zone Com.....	30
5.3.4	Mostrar la historia de los datos.....	30

5.4	Configuración de X-zone Com .....	32
5.4.1	Formulario "aparato" .....	33
5.4.2	Formulario de "registrador de datos" .....	34
5.4.3	Formulario "GSM/GPRS" .....	35
5.4.4	Formulario "Email" .....	36
5.4.5	Formulario "SMS" .....	38
5.4.6	Formulario "Status" .....	39
5.5	GAMA DE valores de medición .....	40
<b>6</b>	<b>Manejo del X-zone Com .....</b>	<b>41</b>
6.1	GAMPO DE USUARIO .....	41
6.2	Conectar el aparato .....	41
6.3	Desconectar el aparato.....	42
6.4	Visualizaciones de pantalla .....	42
6.4.1	Vista sinóptica de símbolos .....	42
6.4.2	Señalización de errores .....	43
6.5	Ejecución de la comprobación del funcionamiento .....	44
<b>7</b>	<b>SMS al X-zone Com .....</b>	<b>45</b>
7.1	Órdenes SMS a leer .....	46
7.1.1	Pregunta de estado .....	46
7.1.2	Consulta de informaciones sobre el estado del grupo .....	47
7.1.3	Valores de medición X-zone 5x00 conectado localmente.....	48
7.1.4	Pregunta de los valores de medición máximos en un grupo.....	49
7.1.5	VISUALIZAR LAS CORDENADAS GPS .....	50
7.1.6	Consulta de las alarmas actual.....	51
7.2	Órdenes SMS a ejecutar .....	53
7.2.1	Confirmación de alarma.....	53
7.2.2	Activar la alarma de evacuación.....	53
7.2.3	Concluir la alarma de evacuación .....	54
<b>8</b>	<b>Vista sinóptica Mcloud.....</b>	<b>55</b>
8.1	Lista de aparatos Mcloud.....	55
8.2	Estado de aparato Mcloud.....	57
8.3	Valores de medición Mcloud.....	58
8.4	Representación de mapa MLOUD.....	59
<b>9</b>	<b>Mantenimiento y conservación .....</b>	<b>61</b>
9.1	Intervalos .....	61
9.2	Limpieza.....	61
9.3	Cambio de la batería en caso de reparación.....	61
<b>10</b>	<b>ANEXO .....</b>	<b>62</b>
10.1	Códigos de error .....	62
10.2	Lista de pedidos.....	63
10.3	ACTualización de Firmware.....	64
10.4	CERTIFICADOS .....	66



# 1 GENERALIDADES

## 1.1 DESCRIPCIÓN DEL FUNCIONAMIENTO

Die Unidad de localización y comunicación X-zone Com se ha concebido para el empleo en entornos industriales. Amplía el sistema de alarma de gas Dräger X-zone 5x00 con Dräger X-am 5x00 (en adelante se menciona como X-zone 5x00).

Conectado a una X-zone 5x00, el X-zone Com registra regularmente las concentraciones de gas y valores de alarma de X-zone 5x00 así como los memoriza hasta que pueda enviarlos al servidor ORI Mcloud o a un receptor de mensajes electrónicos (e-mails) definido por el usuario. Si el X-zone 5x00 (inalámbrico o por cable) se encuentra conectado con otros X-zone 5x00, se transmiten adicionalmente los valores de alarma de la red. En el caso de una red de X-zone cerrada (grupo), en lugar de los valores de medición de gas del X-zone 5x00 conectado, se leen, memorizan y transmiten las concentraciones de gas máximas del grupo.

X-zone Com añade a todos los valores de medición de X-zone 5x00 datos relativos a la posición en la medida en que se determine una posición por GPS.

Por lo demás, está en disposición de recibir las consultas sobre el estado vía SMS y transmitir vía SMS y e-mail en caso de alarma.

A través de Bluetooth o conexión serial, el usuario puede configurar X-zone Com sirviéndose de software de ordenador (que en adelante se denominará Manager Software).

## 1.2 USO PRESCRITO

X-zone Com puede emplearse en entornos con peligrosidad de explosión de las zonas 1 y 2 (según  II 2G Ex ib [Ia IIC Ga] [Ib IIC] IIB T3/T4 Gb) junto con el intensificador de alarma Dräger X-zone 5x00. ¡Un uso diferente a éste o una remodelación del dispositivo sin consulta por escrito al fabricante se consideran como no conforme a lo prescrito y tiene como consecuencia la pérdida de la autorización ATEX (entornos potencialmente explosivos) y de la garantía!

De los daños causados por un uso impropio o no conforme a lo prescrito no se responsabiliza el fabricante; el riesgo corre exclusivamente a cargo del explotador. Si el dispositivo se emplea impropriamente o no según lo prescrito, pueden derivarse peligros de él. Si puede percibirse que no es posible el empleo sin peligros, sírvase poner el dispositivo inmediatamente fuera de servicio.

Como parte del uso prescrito forma parte también el conocimiento preciso y la observación de estas instrucciones de servicio.

### INDICACIÓN



Lea a fondo las instrucciones de servicio extra de Dräger X-zone 5x00 y los dispositivos de medición de gas Dräger X-am 5x00 conectados. Observe especialmente las correspondientes indicaciones de seguridad.

## 1.3 ALMACENAMIENTO Y REENVÍO

**Almacenamiento:** suprima las conexiones que acaso existan con el X-zone 5x00. Por favor, observe las prescripciones del fabricante relativas a X-zone 5x00. Almacene el X-zone Com desconectado con el cargador conectado fuera de la zona de peligrosidad de explosión pero no a la intemperie. En el caso de un almacenamiento sin cargador de batería debe realizarse a lo más tardar tras 6 meses una recarga completa del acumulador interno, lo cual requiere 48 horas.

**Reenvío:** las siguientes medidas han de tomarse antes de que el dispositivo se reenvíe a ORI Abwassertechnik GmbH & Co. KG, por ejemplo con motivo de una reparación:

- Elimine todas las suciedades. Esto es especialmente importante cuando las suciedades sean nocivas para la salud, por ejemplo cuando sean combustibles, tóxicas, corrosivas, cancerígenas, etc.

Los costes que surjan por causa de la limpieza insuficiente del dispositivo, posible eliminación de desechos especiales o daños personales (quemaduras químicas, etc.), se pondrán en cuenta al explotador.

## 1.4 ELIMINACIÓN

**Embalaje:** guarde el embalaje del dispositivo por si necesitara transportarse con posterioridad. De lo contrario los materiales empleados en el embalaje (madera, cartón y PE) pueden desecharse por las vías habituales.

**X-zone Com:** no está permitido que se deseche como basura comunitaria (según la directiva 2002/96/CE). Observe la compatibilidad medioambiental, los riesgos para la salud y las prescripciones locales relativas a las basuras. Limpie y desinfecte, pues, el dispositivo y haga la eliminación en un puesto de colecta autorizado para ello. Puede contar con demás informaciones solicitándolas a las autoridades. En el caso de envío franco casa, si lo solicita, nos haremos cargo de la eliminación gratuita de su dispositivo viejo X-zone Com. Observe a este respecto el apartado relativo al reenvío que se encuentra más arriba.



**Bloque acumuladores:** los bloques acumuladores que se contienen en X-zone Com no deben desecharse con obasura comunal (según directiva 2006/66/CE). Deben eliminarse según las prescripciones vigentes en los puestos locales de colecta de pilas.

## 2 INDICACIONES RELATIVAS A LA SEGURIDAD

### 2.1 SEÑALIZACIONES DE SEGURIDAD Y SÍMBOLOS

El servicio correcto y seguro del dispositivo sólo se puede garantizar si observa Usted pulcramente las indicaciones relativas a la seguridad de estas instrucciones de servicio. Las indicaciones relativas a la seguridad contenidas en estas instrucciones de servicio hacen referencia al grado de peligrosidad que cabe esperar y se señalizan con los siguientes símbolos y colores:

**ADVERTENCIA**



Las advertencias avisan de situaciones de peligro potencial, que pueden tener como consecuencia heridas graves / la muerte de personas o riesgos para la seguridad. Observe exactamente las instrucciones de trabajo y tome las medidas de precaución pertinentes.

**CUIDADO**





Con „cuidado“ se indica situaciones de peligro potencial que, de no observarse correctamente, podrían tener como consecuencia el sufrir heridas, un funcionamiento defectuoso, daños del dispositivo o del medio ambiente. Observe las instrucciones con exactitud.

**INDICACIÓN**



Indicaciones generales, informaciones o sugerencias que, en todo caso, no previenen de peligros.

Demás símbolos:

Símbolo	Descripción
	Llevar indumentaria de protección
	Leer las instrucciones de servicio

---

## 2.2 INDICACIONES RELATIVAS A LA SEGURIDAD

---

Las siguientes indicaciones de seguridad deben observarse respecto de X-zone Com.

### **CUIDADO**



*El dispositivo ha de someterse regularmente a inspecciones y trabajos de mantenimiento a cargo de especialistas técnicos (véase IEC 60079-1).*

### **ADVERTENCIA**



#### **¡Peligro de explosión!**

*En el caso de daños de la carcasa o partes de ella ha de ponerse el dispositivo inmediatamente fuera de servicio y asegurarse contra una nueva puesta inintencionada en servicio.*

### **ADVERTENCIA**



#### **¡Peligro de explosión!**

*Los trabajos de reparación, servicio y mantenimiento solamente deben llevarse a cabo en un entorno sin peligro de explosión.*

### **ADVERTENCIA**



#### **¡Peligro mortal!**

*¡Observar terminantemente las instrucciones relativas a la seguridad de los Dräger X-zone 5x00 y Dräger X-am 5x00 conectados!*

---

## 2.3 SEGURIDAD DEL SERVICIO

---

**Reparaciones:** las reparaciones y demás medidas a tomar en el aparato que no se describan en estas instrucciones de servicio solamente deben llevarse a cabo en la empresa del fabricante o por un servicio autorizado por el fabricante.

**Progreso técnico:** el fabricante se reserva la posibilidad de adaptar los datos técnicos según la técnica evolucione sin aviso previo especial. Puede solicitar a ORI Abwassertechnik GmbH & Co. KG informaciones sobre las actividades y posibles ampliaciones de estas instrucciones.

## 3 ESTRUCTURA Y DATOS TÉCNICOS

Las indicaciones de estas instrucciones de servicio son válidas exclusivamente respecto del tipo de dispositivo que se indica en la primera página.

X-zone Com cuenta con una batería integrada, con la cual funciona en los entornos potencialmente explosivos (según directiva 94/9/CE). Los paneles de operador se manejan por medio de barritas o bastoncillos magnéticos adjuntos. Se ha integrado un módem GSM/GPRS para transmitir alarmas, estados y datos. Los valores de datos transmitidos por X-zone 5x00 se deponen en una memoria de datos interna. Pueden memorizarse unos 262.000 juegos de datos. La memoria de datos se ha concebido como memoria circular, de modo que al transferirse los 262.000 juegos de datos se sobrescribe la memoria más vieja en cada caso.

### 3.1 DIMENSIONES

#### 3.1.1 X-zone Com + X-zone 5x00



Figura 3.1: Dimensiones de X-zone Com y X-zone Com mit X-zone 5x00.

### 3.1.2 Cargador de batería I.S. Power supply 02617PS



Figura 3.2: Dimensiones del cargador de batería en milímetros

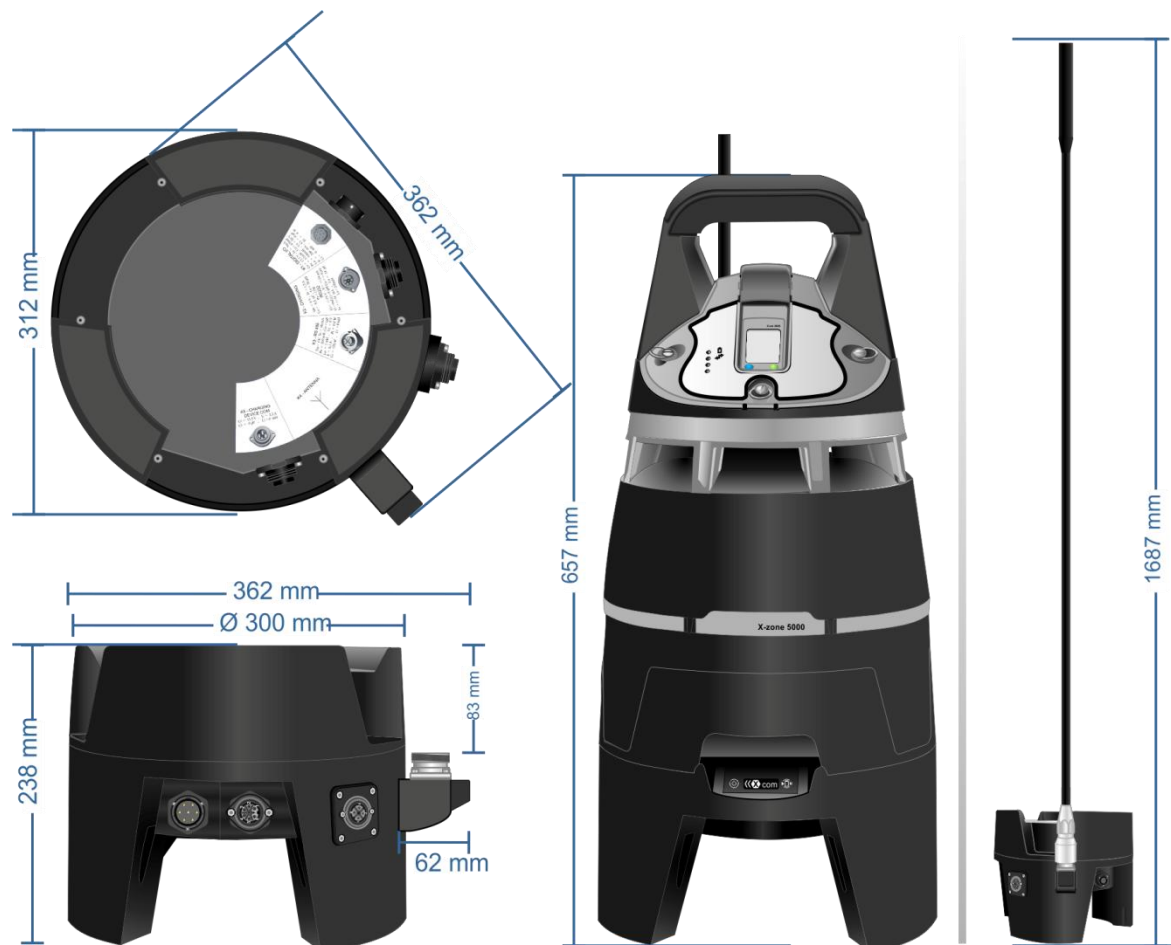

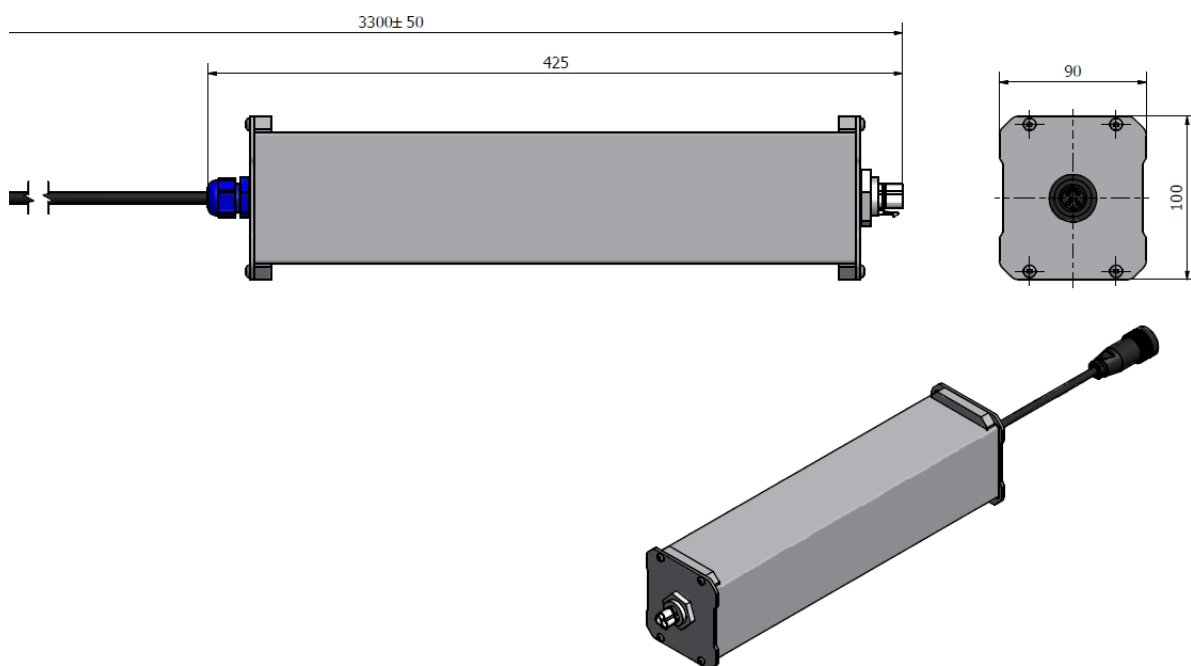

## 3.2 INTERFACES DEL X-ZONE COM Y DEL CARGADOR DE BATERÍA

### 3.2.1 X-zone Com

El X-zone Com contiene diversas interfaces para la transmisión de datos (K3=RS485, K2=RS232), una entrada/salida digital (K1), la conexión a un cargador de baterías (K5) así como un zócalo para la antena de GSM/GPRS (K4).



Figura 3.3: Disposición de interfaces del X-zone Com.

	Función	Modelo	Vista	Asignación
<b>K1</b>	I / O digital	clavija 7 polos		3. GND 4. Normally closed (NC) 5. Normally open (NO) 6. Common (COM) 7. Input
<b>K2</b>	RS232 interfaz serial (DTE)	casquillo 7 polos		1. TxD 2. CTS 3. RTS 4. Charging + 5. Charging GND 6. GND (RS232) 7. RxD
<b>K3</b>	RS485 conexión X-zone 5x00	casquillo 3 polos+PE		1. PLUS (+) 2. MINUS (-) 3. GND
<b>K4</b>	casquillo para antena	casquillo HF 7/16 DIN		
<b>K5</b>	conexión para la carga X-zone Com	clavija 3 polos + PE		1. Charging + 2. Charging GND
	batería interna	clavija 7 polos		1. Communication (SCL) 2. Communication (SDA) 3. RESET 4. appliance output (+) 5. appliance GND 6. Input external source (+) 7. Input external source (GND)

## 3.2.2 Cargador de batería I.S. Power supply 02617PS

Del cable de suministro del cargador de baterías se dispone en tres modelos diferentes:

Con clavija de suministro	País / región	Núm. de pedido ORI	Núm. de pedido Dräger
CEE 7/7	Europa	Contenido en el volumen de suministro	8325 391
AS3112	Australia	8094 140	8325 393
BS 1363	Gran Bretaña	8094 141	8325 392



Figura 3.4: Cable de suministro del cargador de baterías (para Europa, Australia, Gran Bretaña).

Función	Modelo	Vista	Asignación
<b>clavija de suministro</b>	CEE 7/7		
<b>conector de entrada</b>	Wieland RST20i3S 3 polos		1. L1 (negro) 2. N (azul) 3. PE (verde/amarillo)
<b>casquillo de salida</b>	Binder RD24 Serie 693 - 3 polos+PE		1. PLUS (+) 2. GND 3. Normally closed (NC) 4. Normally closed (NC)

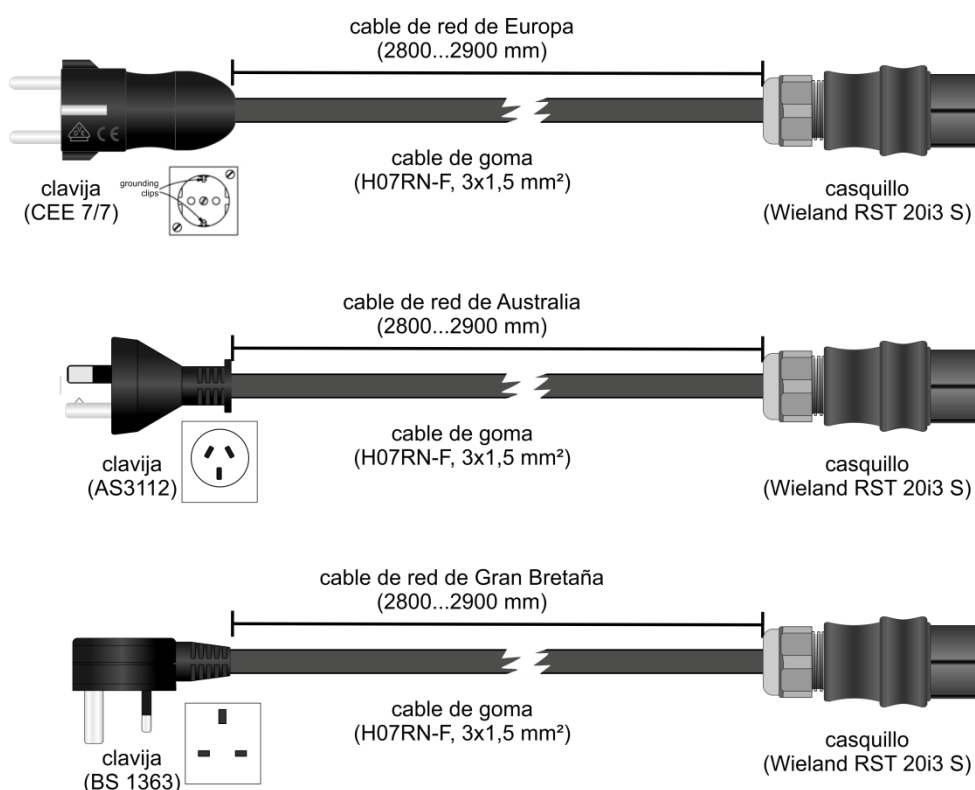

### 3.3 SEÑALIZACIÓN

La placa de tipo colocada en la cara superior del X-zone Com contiene las siguientes indicaciones:

- denominación del aparato
- nombre y dirección del fabricante
- señalización de la CE
- señalización de la serie y número de tipo
- número de serie, el año de construcción se encuentra el número de serie
- departamento de certificación, año de la autorización, número de autorización y tipo de protección de aparato
- señalización Ex (explosividad)

Al hacer una consulta y solicitar piezas de repuesto es importante indicar la denominación del aparato y el número de serie.



Figura 3.5: A) Placa de tipo del X-zone en la cara superior de la carcasa.

B) Informaciones relativas a las conexiones en la cara inferior de la carcasa.

## 3.4 ESPECIFICACIONES DEL DISPOSITIVO

### 3.4.1 X-zone Com

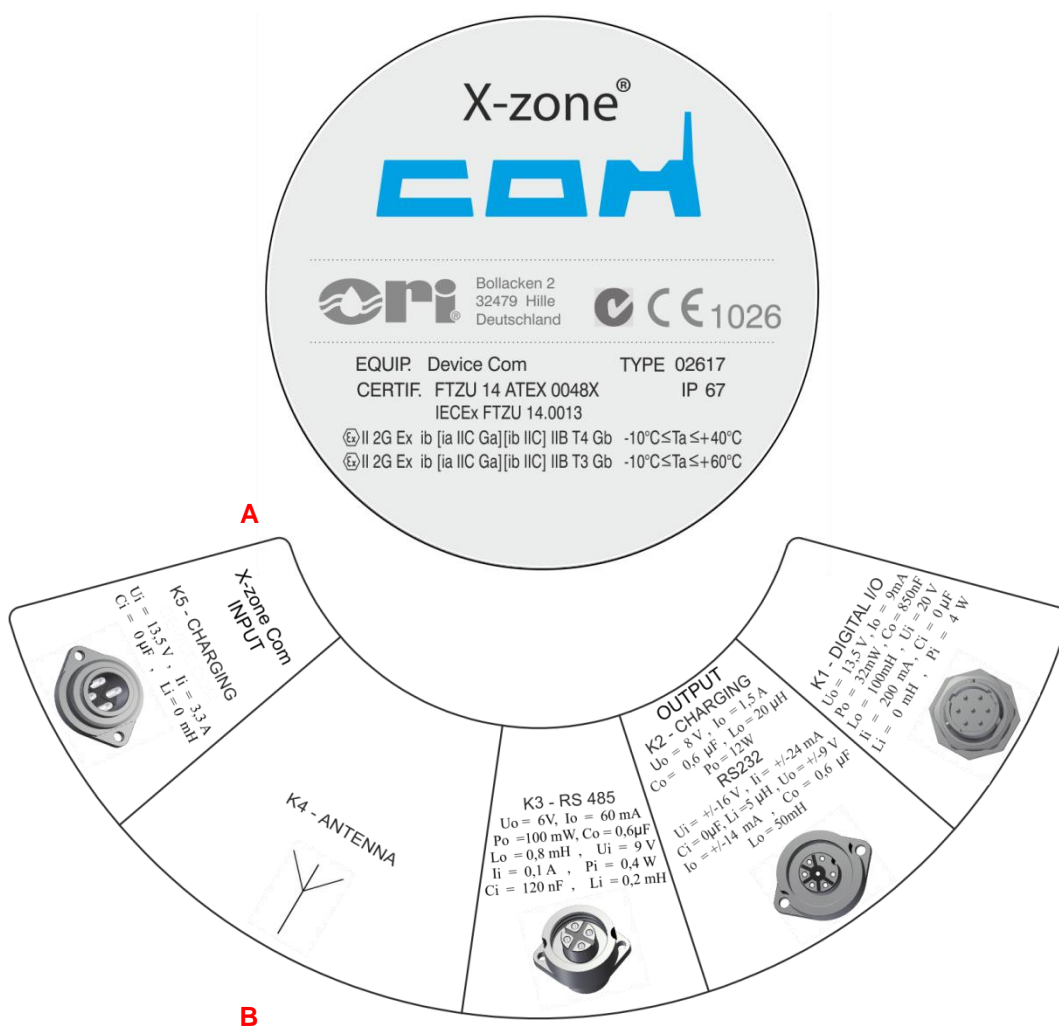
Datos técnicos: X-zone Com		
ATEX / IECEx	IECEx FTZU 14.0013X	Ex ib [ia IIC Ga] [ib IIC] IIB T3/T4 Gb
Señalización	FTZU 14 ATEX 0048X	⊕ II 2G Ex ib [ia IIC Ga] [ib IIC] IIB T3/T4 Gb
Clase de protección IP	<b>IP 67</b>	(con conexión cerrada de clavija)
dimensiones (ØXH); peso	362 x 238 mm; 9,8 kg	(sin Dräger X-zone 5x00)
Gammas de temperatura	<b>temperatura ambiente</b>	-10°C .. + 60°C, grupo de temperatura T3 -10°C .. + 40°C, grupo de temperatura T4
	<b>temperatura de almacenamiento</b>	-20°C .. + 60 °C (sin batería) 0°C .. +50°C (batería) 0°C .. + 50°C (cargador de batería)
	<b>Cada, servicio búfer</b>	+5°C .. +30°C (duración de carga de 30 h) (con desconexión de carga automática con temp. batería inferior a 0°C y superior a +45°C)
Humedad relativa del aire	5 - 95%	
Memoria de datos interna	8 MB, aprox. 262000 juegos de datos	
Batería interna (tipo NiMh)	Tensión nominal de salida	12 V
	Tensión de salida máxima	15 V
	Corriente nominal de salida	0,92 A
	Capacidad	13,5 Ah
	Recargable internamente	9...15 VDC / 1,5A
Comunicación inalámbrica	<b>Bluetooth</b>	v3.0; class 1 (antena interna), módem 4dBm
	<b>GSM/GPRS</b>	ERP tipo Mgsn
	<b>Antena</b> (de fábrica)	Quadband 850/900/1800/1900 MHz Dualband 900 /1800 MHz
Interfaz física autosegura	<b>1 x RS485 (K3)</b>	conexión de Dräger X-zone 5x00
	<b>1 x RS232 (K2)</b>	RS232 + carga opt. de disp. de otro fabricante
	<b>1 x DI/DO (K1)</b>	para Switch optativo ON/OFF Box
	<b>1 x K5</b>	X-zone Com alimentador/cargador de batería
	<b>1 x HF 7/16 DIN (K4)</b>	antena
Módulo GPS	con antena interior	
Pantalla	OLED	
Estándares empleados armonizados	ETSI EN 300 328 V1.7.1:2006; ETSI EN 301 489-1 V.1.8.1:2008 : ETSI EN 301 489-7/V1.3.1:2005; ETSI EN 301 489-17/ V2.1.1:2009; ETSI EN 301511 V9.02:2003; EN 60079-0: 2012; EN 60079-11:2012; EN 60079-26: 2007 EN 50581:2012; EN 60950-1:2006; EN 61000-6-2:2005; EN 61000-6-3:2007	
Directiva de la EU aplicada	94/9/EC - ATEX 2004/108/EC - EMC 1999/5/EC - R&TTR	

### 3.4.2 Cargador de batería

Datos técnicos: Cargador de batería I.S. Power Supply Unit 0217PS		
Clase de protección IP	IP 65	⊕ II (2)G [Ex ib Gb] IIB
Clase de protección eléctrica	I	
Dimensiones (L x B x H); peso		425 x 90 x 100 mm sin cable 3300 ± 50 x 90 x 100 con cable 1 kg
Temperatura ambiente durante la carga		+5°C..+30°C ( <i>duración de carga de 30 h</i> ) ( <i>con desconexión de carga automática con temp. batería inferior a 0°C y superior a +45°C</i> )
Humedad relativa del aire	≤ 90%	
Datos eléctricos	<b>Tensión de entrada</b>	90-230 VAC; 47 - 63 Hz 135-370 VDC;
	<b>Corriente de entrada</b>	1 A
	<b>Tensión nominal de salida</b>	12 VDC (nominal)
	<b>Corriente nominal de salida</b>	2 A (constante)
Especificaciones autoseguras	<b>Uo</b>	13,5 V
	<b>Io</b>	2,8 A
	<b>Co</b>	50 μF
	<b>Lo</b>	30 μH

## 4 MONTAJE Y PUESTA EN SERVICIO

X-zone Com ha de configurarse con motivo de la primera puesta en servicio por medio del software de ordenador (ORI Manager Software). El modo en que ha de instalar el Manager Software en su ordenador se ilustra a continuación. Seguidamente se describen las fases mecánicas para la puesta en servicio de X-zone Com.

### 4.1 INSTALACIÓN DEL MANAGER SOFTWARE

#### 4.1.1 Requisitos del sistema

Para la instalación del Manager Software han de darse las siguientes condiciones:

- Sistema operativo Microsoft Windows XP / Vista / 7 / 8 - 32bit o 64bit
- Microsoft .NET Framework instalado
- Aprox. 10 MB de memoria de disco duro (sin NET Framework)

#### INDICACIÓN



*Microsoft .NET Framework puede descargarse gratuitamente en el sitio web de Microsoft. Observe a este respecto que ha de descargar la versión adecuada para su sistema operativo (32 bit o 64 bit). Si se dan problemas sírvase ponerse en contacto con su especialista en informática.*

#### 4.1.2 Instalación de Manager Software

Coloque el CD, el proceso de la instalación se inicia automáticamente. En el caso de que la instalación no se inicie por sí misma, ejecute el fichero "setup.exe" o el fichero "manager\_setup.msi" desde su medio de instalación y siga las instrucciones.

#### INDICACIÓN



*Este programa de ordenador se encuentra protegido por la ley de protección de autoría y contratos internacionales. La reproducción o el empleo no autorizados de este programa o de sus partes están prohibidos.*

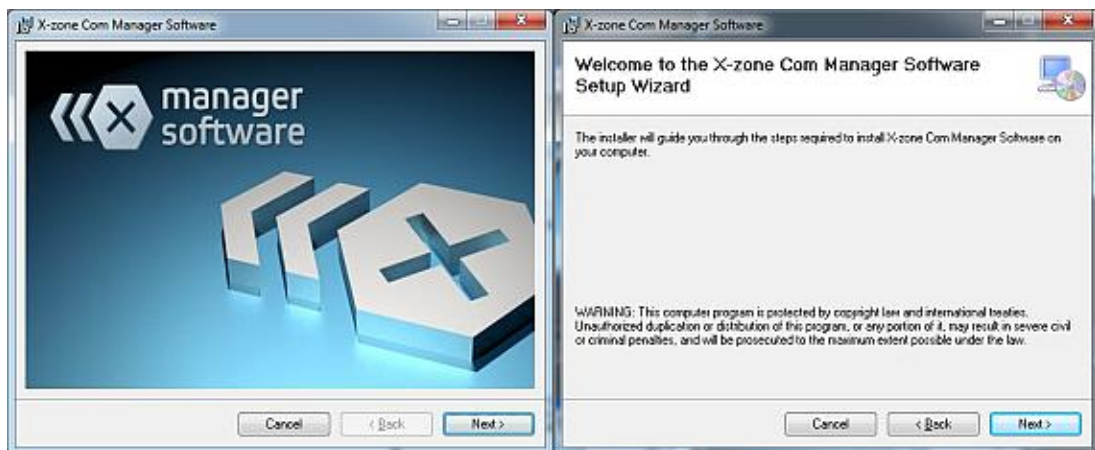



Figura 4.1: Asistente de instalación del Manager Software.

El Manager Software se instala se serie en el siguiente directorio:

```
c:\Program Files (x86)\X-zone Com\Manager Software\
```

Para la selección de otro directorio ha de hacer clic en **[Browse...]** o irse directamente a la ruta de la memoria en el campo textual bajo "Folder:".

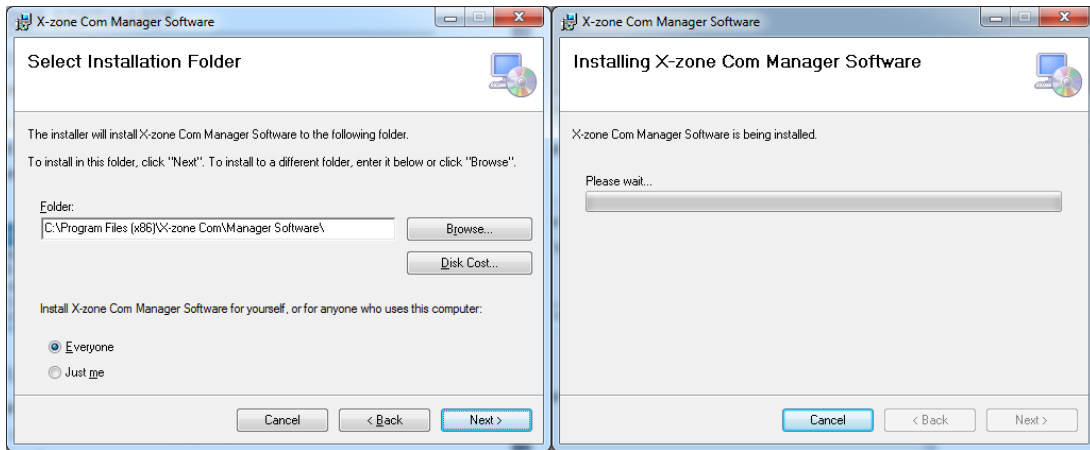
La selección de **[Everyone]** surte el efecto de que la instalación del software sea para todos lo usuarios del ordenador.

La selección de **[Just me]** surte el efecto de que la instalación del software sea sólo para el actual usuario registrado.

Para instalar el programe en este directorio haga clic en **[Next>]**. En el escritorio se crea automáticamente un acceso al programa.



Figura 4.2: La instalación se ha realizado con éxito.

Tan pronto como la instalación se haya concluido con éxito, cierre el asistente de la instalación haciendo clic en **[Close]**.

## 4.2 PRIMERA PUESTA EN SERVICIO

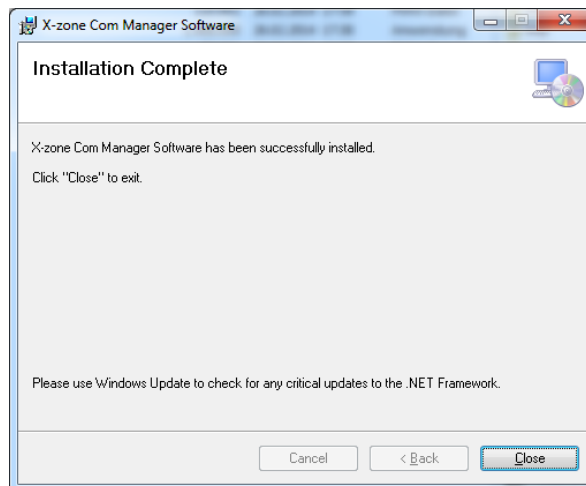

El montaje, la instalación eléctrica, la puesta en servicio, el manejo y el mantenimiento del X-zone solamente debe ser llevado a cabo por personal especializado debidamente formado. El personal especializado ha de haber leído y comprendido las instrucciones de servicio. En la instalación, el servicio, el mantenimiento y el transporte han de llevar Usted la indumentaria de protección prescrita. Compruebe una vez más que todas las conexiones se han realizado correctamente antes de conectar el sistema.

### 4.2.1 Cargar el acumulador (batería)

Al cargar el X-zone Com la conexión del dispositivo de red o del cargador de batería (en adelante mencionados como “bloque de alimentación”) debe encontrarse en la tensión de suministro fuera de una atmósfera susceptible de explosiones y de la zona de explosión indicada. Por lo demás ha de poner Usted a seguro antes de la conexión del dispositivo de red o del cargador de batería a la tensión de suministro que éste concuerde con el valor indicado en la placa de tipo. Seguidamente conecte el bloque de alimentación con la conexión K5 del X-zone Com (véase capítulo 4.2.4).



Figura 4.3: la conexión del cargador de batería y del bloque de alimentación del X-zone Com con la tensión de suministro ha de realizarse siempre fuera de la zona susceptible de explosión indicada.

Durante el proceso de carga la temperatura ambiente ha de ser entre +5°C y +30°C, de lo contrario puede prolongarse el proceso de carga mismo (véase a este respecto también el capítulo 6.4).

### ADVERTENCIA

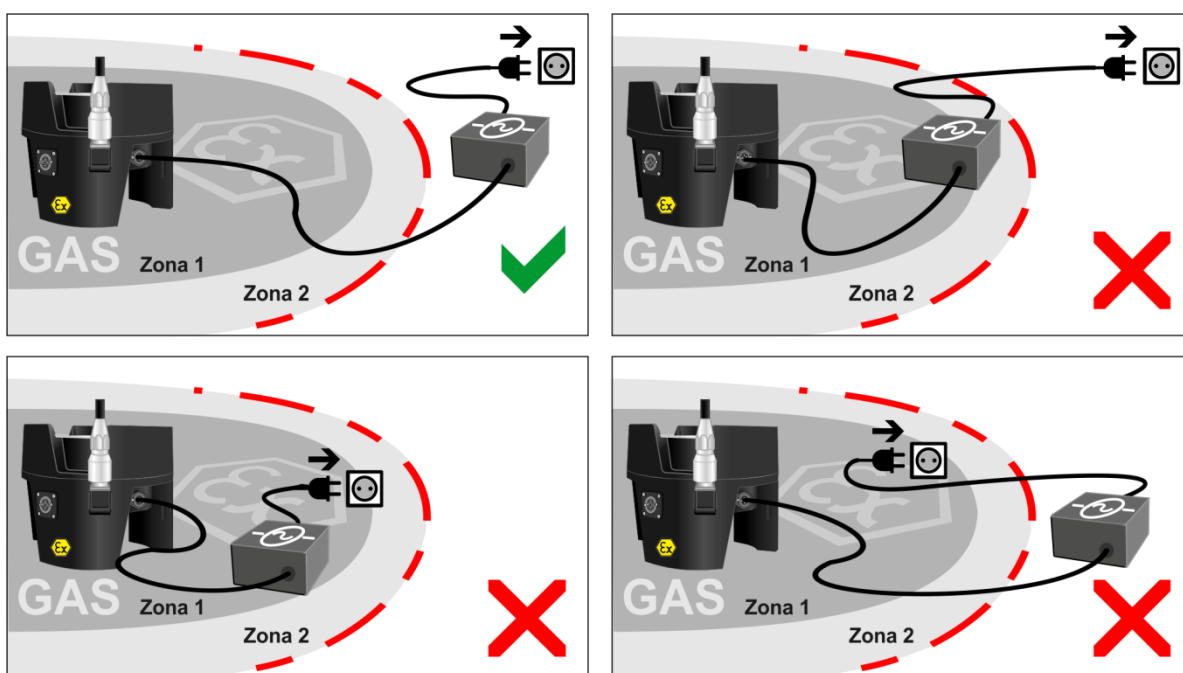

#### **¡Peligro de explosión!**

Al cargar el X-zone Com no conectar el bloque de alimentación a la tensión de suministro dentro de la zona susceptible de explosiones.

### INDICACIÓN



Observe que la batería se cargue con regularidad completamente (a lo más tardar cada semestre). De lo contrario se da el peligro de carga baja y daño de la batería. Guarde el X-zone Com desconectado con el bloque de alimentación conectado fuera de la zona susceptible de explosiones.

En la pantalla del X-zone Com puede observarse el estado de la carga por medio de un aumento del llenado cíclico de la batería (véase capítulo 6.4)



#### Significados:

1. Descargar la batería (el X-zone Com se desconecta).
2. Si la batería se encuentra conectada al cargador, el símbolo señala un sobrecalentamiento y una detención momentánea del proceso de carga. Cuando la temperatura de la batería descienda, prosigue el proceso de carga.



Carga al 100% de la batería

## 4.2.2 Colocar la tarjeta SIM

A fin de poder emplear el X-zone Com para enviar e-mails y SMS, ha de colocarse en el módem interno una tarjeta SIM.

Para el empleo del módem GSM el cliente ha de colocar una tarjeta M2M SIM, la cual es apropiada para la comunicación de datos y SMS. En relación al volumen de datos requerido y la cantidad de SMS necesaria deben seleccionarse provisoriamente con el provider los contratos pertinentes. Las tarjetas SIM, apropiadas también para la comunicación verbal (lo mismo cabe decirse de las tarjetas Twin) o concebidas principalmente para el empleo en un smartphone, tablet o unidad USB/GSM, deben activarse y comprobarse previamente en un smartphone/tablet/unidad USB GSM. Los servicios del tipo „mediación de servicios de habla“ o semejantes deben desactivarse en este caso. Tras la activación/adaptación con éxito, puede emplearse la tarjeta SIM también en el módem GSM del X-zone Com.

## ADVERTENCIA



### **¡Peligro de explosión!**

*La carcasa del producto no debe abrirse dentro de una atmósfera susceptible de explosiones!*

*La colocación o la toma de una tarjeta SIM sólo debe llevarse a cabo en un entorno no susceptible de explosiones.*



Figura 4.4: Abrir la carcasa de X-zone Com (C=clavija de suministro, A = casquillo de la antena).

## INDICACIÓN



*Antes de abrir la carcasa del módem, separa el mismo módem de su suministro de corriente retirando la clavija de suministro.*

Para poner la tarjeta SIM, siga los siguientes pasos:

1. Afloje los seis tornillos por la cara inferior del X-zone Com.
2. Tome la parte superior del X-zone Com con cuidado.
3. Separe el módem de su suministro de corriente.
4. Suelte el módem en caso de necesidad de sus bridas de sujeción.
5. Desatornille la tapa del módem (véase la Figura 4.5).
6. Suelte el bloqueo del soporte de la tarjeta desplazando el soporte mismo en la dirección de la flecha y ábralo abatiendo (véase Figura 4.5).
7. Coloque la tarjeta SIM en el soporte para ello previsto.
8. Cierre el soporte de tarjeta también abatiendo y bloquee desplazando en la dirección contraria.
9. Atornille de nuevo la pata del módem.
10. Conecte de nuevo el suministro de corriente del módem.
11. Coloque la pieza superior encima (observe a este respecto el asentamiento correcto de la junta).
12. Apriete de nuevo con la mano los 6 tornillos.





Figura 4.5: Colocación de la tarjeta SIM. Para ello se desatornilla la tapa del módem, se desplaza el soporte de la tarjeta en la dirección de la flecha y seguidamente se abre abatiendo.

### 4.2.3 Montaje / desmontaje de la antena

**ADVERTENCIA**

**Peligro de explosión!**  
En el casquillo de la antena sólo debe montarse la antena original (núm. de pedido ORI 8094108, núm. de pedido Dräger 8324372).

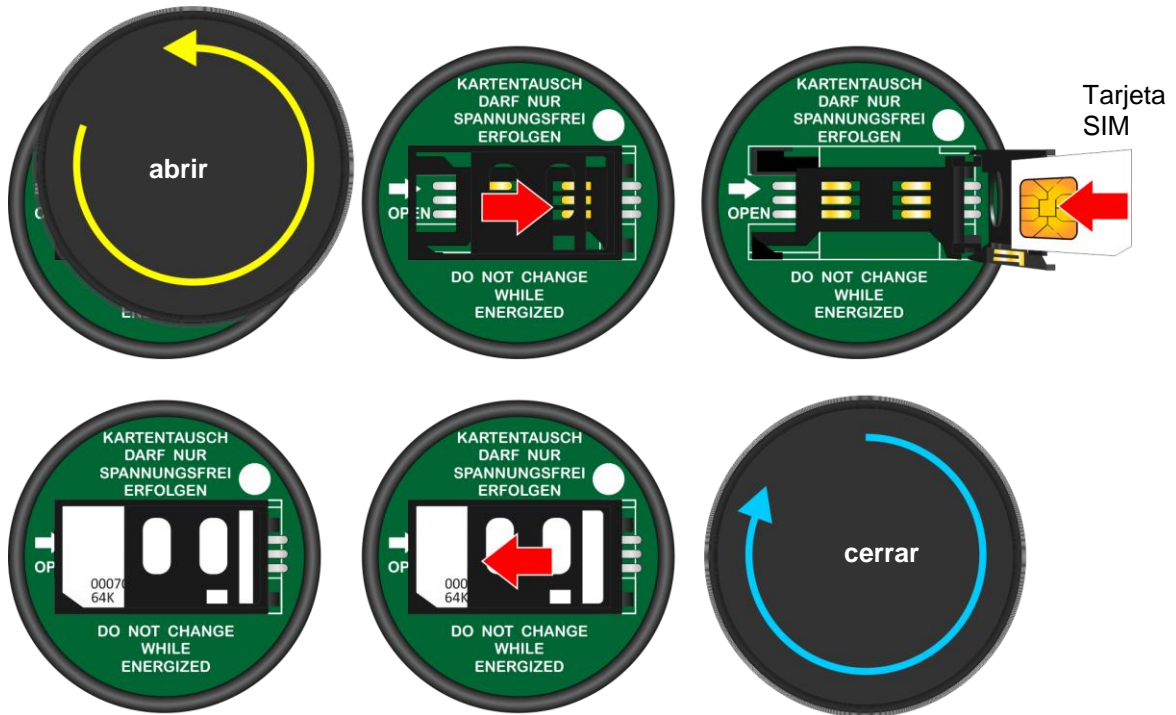
En el montaje o el desmontaje de la antena no debe rotarse la vara de la antena. Para sujetar o aflojar sólo debe girarse la tuerca, pues de lo contrario se da el peligro de que se suelte el contacto del pie de la antena (Figura 4.6).



Figura 4.6: casquillo HF del X-zone Com

## 4.2.4 Conectar con el X-zone 5x00

Sírvase del cable de conexión adjunto señalizado con el color amarillo RS485 (núm. de artículo 8094118), para unir la conexión K3 del X-zone Com con la conexión XEXT2 del X-zone 5x00. Observe al respecto que la clavija en ángulo muestre hacia abajo en el X-zone Com.



Figura 4.7: Conectar la X-zone Com con el X-zone 5x00 sirviéndose del cable de conexión RS485.



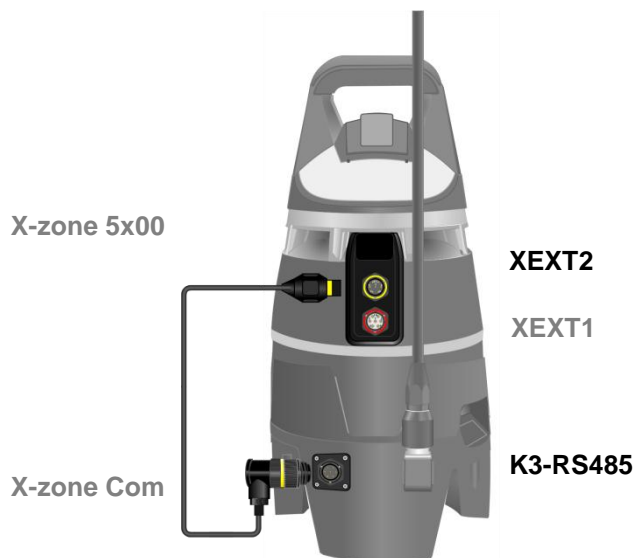

Figura 4.8: Al unir varios X-zone 5x00 sólo con cables de comunicación se conecta el X-zone Com al X-zone 5x00 en el extremo de la secuencia.

**INDICACIÓN**

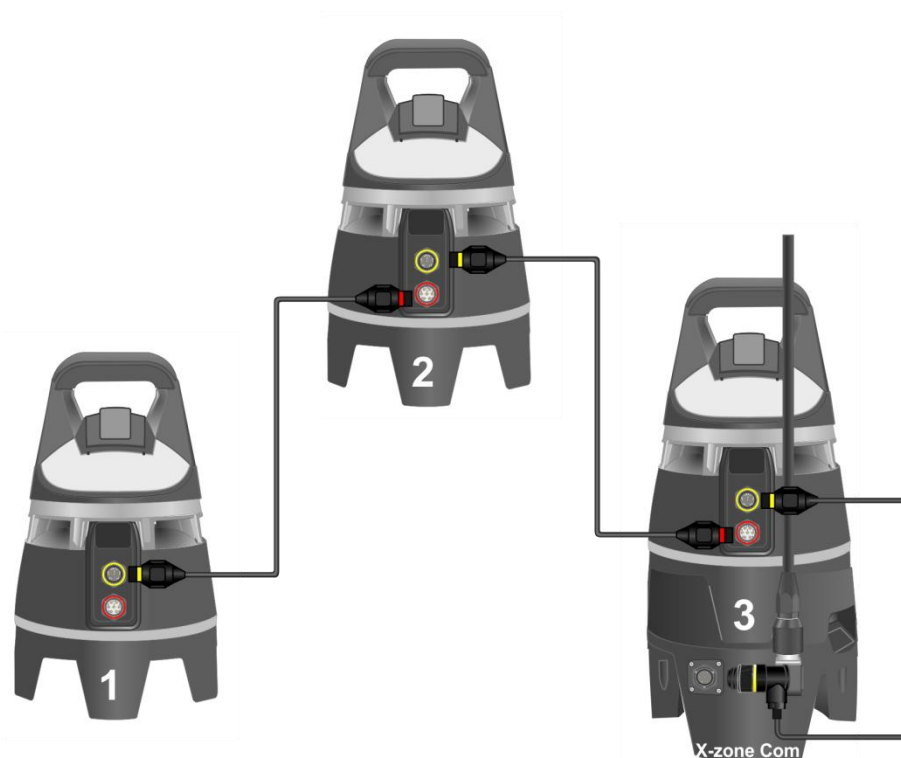

El empleo de un X-zone Com presupone un firmware a partir de la versión 2.22 con el X-zone 5x00 conectado.

Para una actualización de firmware y la configuración del X-zone 5x00 por medio del software de ordenador Dräger CC-Vision póngase en contacto con el asesor de clientes de Dräger.

Observe que en el X-zone 5x00 el protocolo de Modbus se conecta sirviéndose del software de ordenador de Dräger CC-Vision y se configura de la siguiente manera:

Ajuste de X-zone 5x00 Modbus	
Conector Modbus	XEXT2
Dirección de Modbus	2
Velocidad baudios	115200
Paridad	Even



Figura 4.9: Ajuste de Modbus dentro del software de ordenador de Dräger CC-Vision.

**Diferencia entre red cerrada y abierta:**

Una descripción detallada de las funcionalidades de la red se encuentran en las instrucciones de empleo del X-zone 5x00 de Dräger.

*„En el caso de una red inalámbrica conectada un dispositivo principal vigila la conexión inalámbrica a todos los aparatos del grupo y todos los aparatos del grupo vigilan la conexión inalámbrica al dispositivo principal. Cuando un dispositivo o aparato falla, por ejemplo por causa de una batería agotada o supresión de un aparato, se activa una alarma de aparato en el dispositivo principal. Al fallar el dispositivo principal se activa una alarma en todos los aparatos del grupo“.*

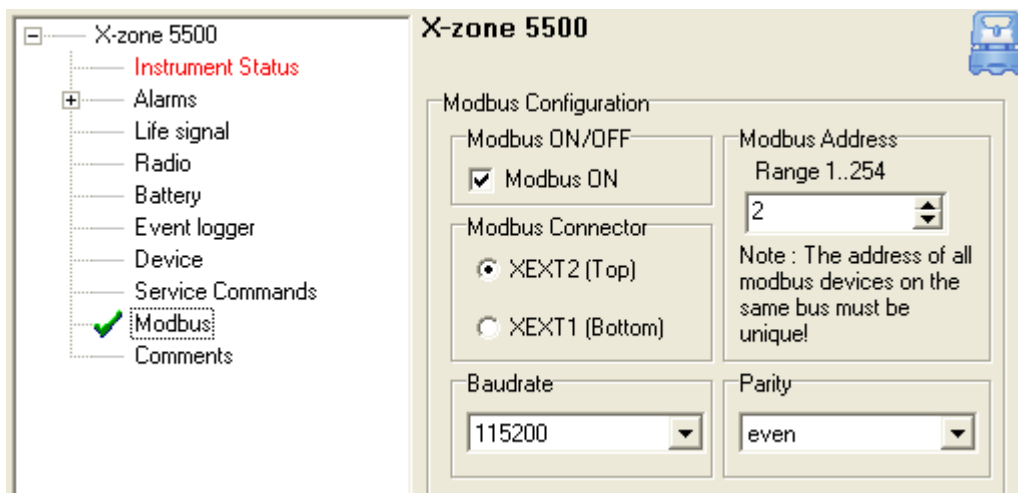
La siguiente tabla muestra diversos tratamientos a través de X-zone Com. El empleo del número de serie o de estación así como los valores de medición locales o máximos son vigentes tantos para los e-mails y SMS enviados por el X-zone Com SMS como para el portal de datos de internet Mcloud y el software Manager.

	Red abierta	Red cerrada (grupo)
Número de identificación del X-zone 5x00	Número de serie	ID dentro del grupo (número de estación)
Valor de medición empleado para un gas	Valor de medición actual del X-zone 5x00	Valor máximo actual procedente del grupo
Informaciones de alarma	✓	✓
Cantidad máxima de X-zone 5x00 en la red	25	15

#### INDICACIÓN



*El X-zone Com puede conectarse en cada X-zone 5x00 de la red inalámbrica. No es necesario conectar, por ejemplo, al aparato principal en la red cerrado.*

#### INDICACIÓN



*El X-zone Com envía regularmente una señal a X-zone. Si la conexión se interrumpe durante más de un minuto, el X-zone 5x00 señala un fallo de aparato.*

### 4.3 SEPARAR DEL X-ZONE 5X00

Si la conexión entre el X-zone Com y X-zone 5x00 se interrumpe durante un lapso superior a un minuto, el X-zone 5x00 señala un fallo de aparato. Para evitar esto mismo deje la conexión RS485 durante tanto tiempo como sea le necesario para desconectar el X-zone Com (véase capítulo 6.3). Procediendo de este modo se evita el fallo de aparato.

## 5 CONFIGURAR EL X-ZONE COM

Para configurar el X-zone Com se necesita el Manager Software, cuya instalación se describe en el capítulo 4.1.

### 5.1 CREAR UN ENLACE AL ORDENADOR

El X-zone Com se une al ordenador bien por medio de una conexión inalámbrica Bluetooth bien por medio de una conexión por cable.

#### 5.1.1 Conexión Bluetooth

La creación de la conexión Bluetooth se describe en adelante ejemplarmente para Windows 7. Dependiendo del sistema operativo el proceso puede ser levemente diferente.

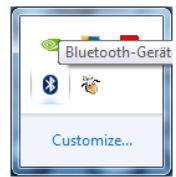

1. Ponga a seguro que en el ordenador se encuentre activado el módulo Bluetooth. En la mayoría de los casos se realiza esto pulsando las teclas funcionales azules rotuladas [FN]+[Bluetooth-Symbol].
2. Asegúrese de que el X-zone Com funcione con la batería completamente cargada.

Caso que el módulo Bluetooth se encuentre activo, haga clic con la tecla derecha del ratón en el símbolo de Bluetooth  que se encuentra en la barra de funciones de Windows y seleccione [Add Device].



Figura 5.1: Integración de Bluetooth en el X-zone Com.

Seleccione seguidamente el aparato y haga clic en [Continuar]. Caso que realice la conexión por primera vez con el X-zone Com, confirme el código de acoplamiento mostrado (en el caso de MS Windows 7). Haciendo clic en [Continuar] se añade el X-zone Com a los aparatos Bluetooth de la red del ordenador empleado.

A cada unión Bluetooth creada le asigna MS Windows un número de puerto COM. Para ver el número marque el aparato y haga clic en [Properties]. Seguidamente seleccione el formulario [Services] (véase Figura 5.2).

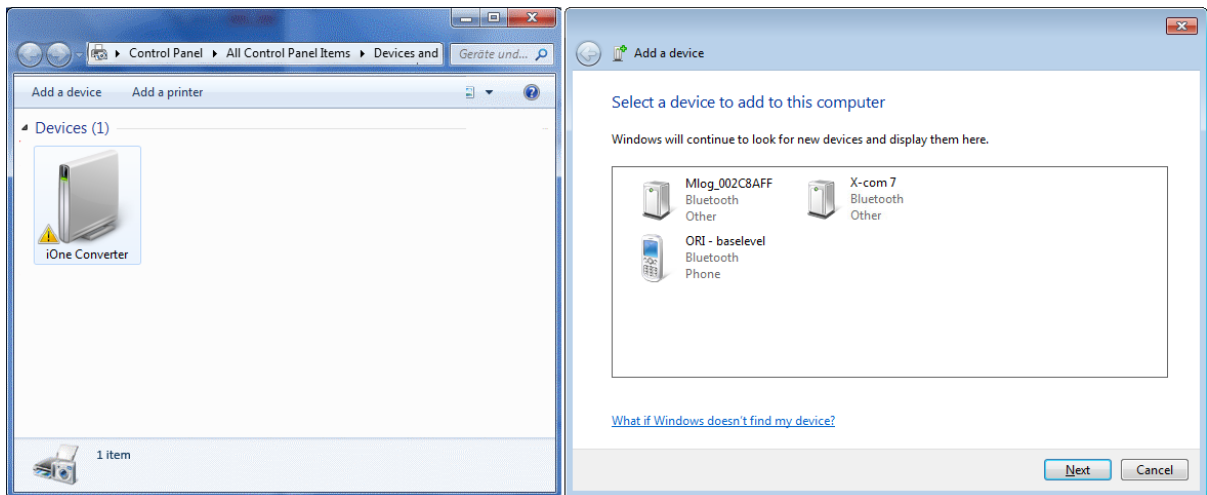

Figura 5.2: Puerto COM asignado en el caso de MS Windows 7.

El Manager Software puede determinar el puerto COM automáticamente; para crear una conexión más rápidamente el puerto COM puede ajustarse manualmente en el Manager Software.

## 5.1.2 Conexión por cable

Como alternativa a la conexión Bluetooth, el X-zone Com puede conectarse con el ordenador por medio de interfaz K2 (RS232) a través del cable suministrado. Habitualmente se necesita para esto un adaptador USB serial en el ordenador.

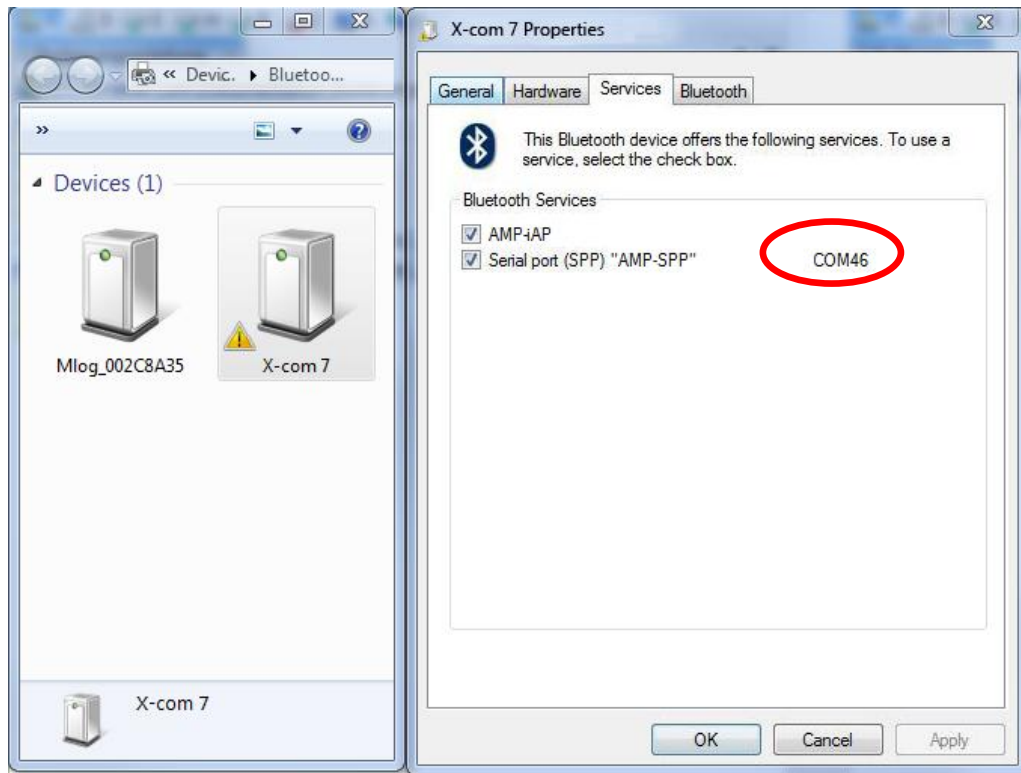
El número de puerto COM asignado por MS Windows ha de ser empleado también en este caso por el Manager Software (ajuste automático o manual).

## 5.2 VISTA SINÓPTICA / VISTA INICIAL

La ventana principal del Manager Software muestra cinco sectores de funciones que se describen a continuación.



Figura 5.3: Ventana inicial del Manager Software.

<b>1</b>	<p><b>Logotipo</b></p> <p>El logotipo se encuentra vinculado con la homepage de ORI (<a href="http://www.origmbh.de/">http://www.origmbh.de/</a>) (se necesita acceso a Internet).</p>
<b>2</b>	<p><b>Informaciones relativas a la conexión</b></p> <p><b>Conexión:</b></p> <p>[COM-Port]: selección de puerto COM.          [Connect]: crea la conexión entre el ordenador y el X-zone Com.          [Disconnect]: finaliza la conexión.</p> <p><b>Nombre del aparato:</b></p> <p>nombre del aparato del X-zone Com definido según el usuario.</p> <p><b>Ajustes:</b></p> <p>[Update]: aceptar los ajustes realizados en el X-zone Com.          [Download]: leer y mostrar los ajustes actuales del aparato.</p> <p><b>Historia de los datos:</b></p>

	[Open Log] carga de los ficheros de datos BSH para la vista de los datos mismos. Función de exportación.
<b>3</b>	<b>Entorno de configuración:</b>  Realizar los ajustes de aparatos, loggers y comunicación. Adicionalmente pueden verse diversas informaciones relativas a ID de aparatos, estado de aparatos y de batería.
<b>4</b>	<b>Gama de valor de medición:</b>  En el caso de una red abierta se muestran los valores de medición actuales del X-zone 5x00 localmente conectado. En caso de alarma se muestran adicionalmente los valores de alarma del dispositivo emisor de la alarma.  En el caso de una red conectado se muestran los valores actuales máximos y de alarma del grupo.
<b>5</b>	<b>Barra de estado</b>  Muestra el estado de la conexión al X-zone Com.  Además puede seleccionar la lengua del Manager Software y visualizar el mismo Manager Software.

## 5.3 INFORMACIONES RELATIVAS A LA CONEXIÓN

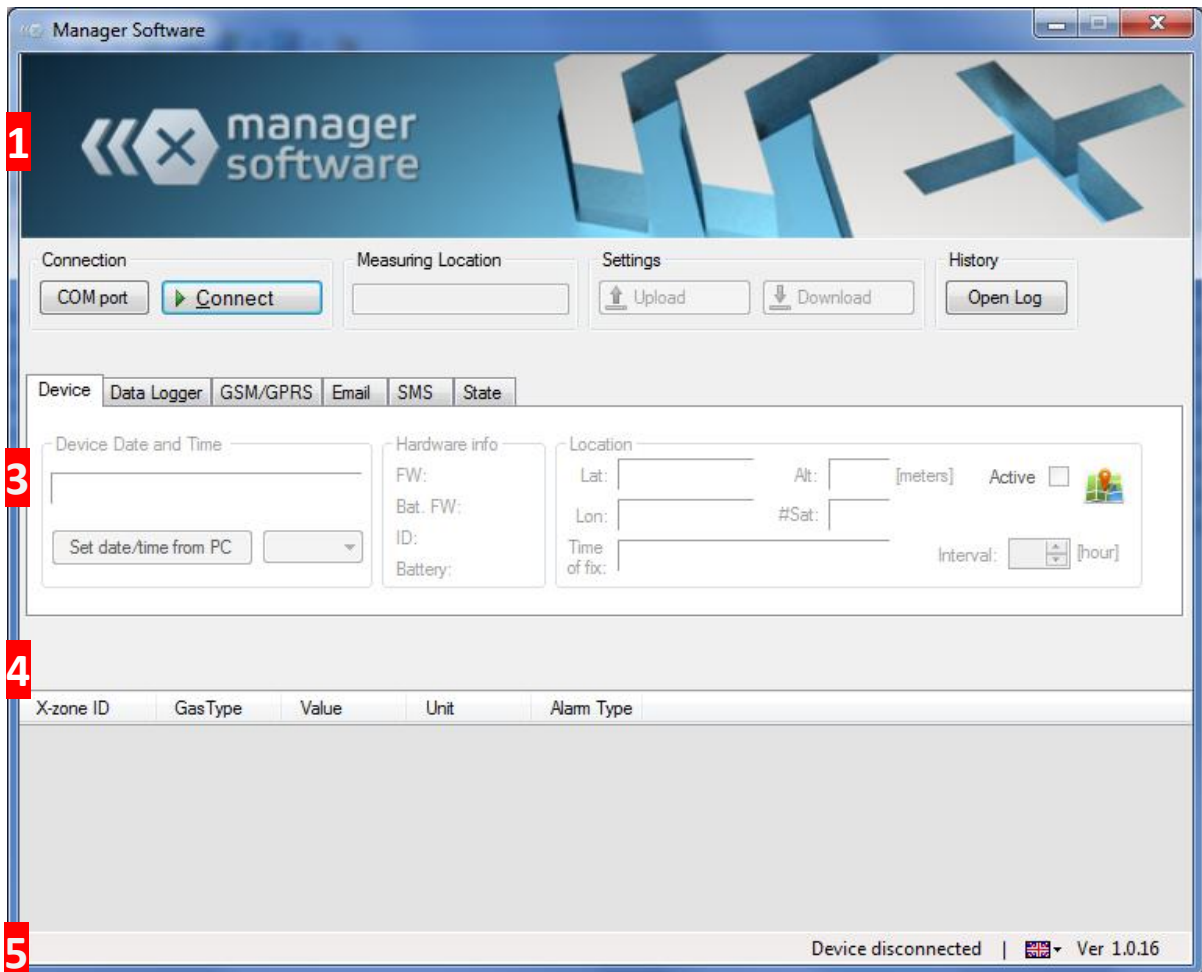
### 5.3.1 Crear la conexión al X-zone Com

La conexión entre el ordenador y el X-zone Com puede realizarse bien a través del cable RS232 o vía Bluetooth. En caso de conexión a través del cable RS232 se asigna por regla general el puerto COM 1.

**INDICACIÓN**



*Para una correcta conexión Bluetooth el módulo Bluetooth del ordenador debe encontrarse activo y el aparato debe ser asignado por el sistema operativo a un puerto Com virtual. Encontrará demás informaciones en el capítulo 5.1*

El Manager Software puede buscar automáticamente el puerto COM para la conexión serial Bluetooth o bien se puede asignar manualmente el puerto COM.

#### 5.3.1.1 Búsqueda automática

La búsqueda automática del puerto COM es el ajuste estándar tras la instalación del software. La señal del gancho [AutoDetect] debe mostrarse puesta como se ilustra en la Figura 5.5.

Haga clic en [Connect] para iniciar la conexión. En la barra de estado aparece „Searching device at:“ („Búsqueda del aparato en:“) así como la indicación del puerto COM en el que actualmente se esté buscando el aparato.





Figura 5.4: Barra de estado del Manager Software al realizarse con éxito la conexión.

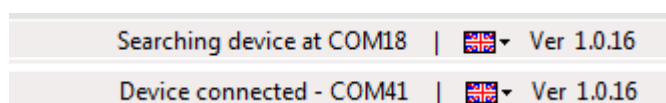

### 5.3.1.2 Selección manual del puerto COM

**INDICACIÓN**

 La selección manual del puerto Com tiene siempre sentido si cuenta con varios X-zone Com, pues de lo contrario se crea la conexión siempre con el primer X-zone Com que se encuentre.

Para la selección manual del número de puerto COM asignado por el sistema operativo haga clic sobre el botón [COM port]. Se abre la ventana representada abajo, "COM Port". Suprime el gancho [AutoDetect] y seguidamente seleccione de la lista el número de puerto COM asignado por el sistema operativo para al X-zone Com.



Figura 5.5: Selección manual del puerto COM virtual de Bluetooth o interfaz serial.

### 5.3.2 Denominación de aparato / modificar el nombre del lugar de medición

Al X-zone Com puede asignársele un nombre de usuario definido en "Measuring Location" ("Nombre de aparato") (por ejemplo un lugar de medición) (no se admiten los signos: „§“, „°“, las metafónicas de la lengua alemana ni la consonante „ß“). Bajo este nombre se muestran en el ORI Mcloud todos los valores de medición transmitidos. Al hacerse el envío de fábrica el nombre del aparato se corresponde al nombre de aparatos ID del X-zone.





Figura 5.6: Asignar al X-zone Com un nombre.

Haciendo clic en [Upload] se escribe el nombre en el X-zone Com. Pueden introducirse máximamente 10 caracteres para el nombre. Las metafónicas y los caracteres especiales de la lengua alemana no se admiten. Caso que no se asigne ningún nombre o ningún nombre válido, no pueden transmitirse los ajustes al X-zone Com y aparece un mensaje de error.

**INDICACIÓN**

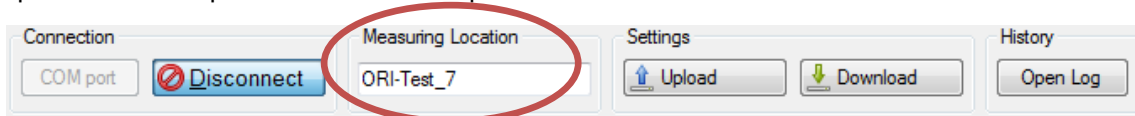
 Los nombres de aparato asignados se necesitan para el registro del X-zone Com en la Mcloud.

### 5.3.3 Memorizar y cargar los ajustes de X-zone Com

Los ajustes llevados a cabo se escriben a través de [Upload] en el X-zone Com tan pronto como todas las introducciones sean válidas. Las introducciones inválidas se marcan en rojo; la memorización no es entonces posible.

Haciendo clic en [Download] se leen los ajustes actuales del X-zone Com y se muestran por medio del Manager Software.



Figura 5.7: Transmitir los ajustes al X-zone Com o leerlos.

### 5.3.4 Mostrar la historia de los datos

**INDICACIÓN**

 Para poder emplear la historia de los datos en el Manager Software no tiene que encontrarse Usted conectado al X-zone Com.

Tras pulsar [Open Log] en "History" ("Historia de datos") aparece una ventana para abrir vía e-mail los ficheros de datos BSH enviados. Para seleccionar un juego de datos de medición el botón [...] se pulsa y se selecciona el fichero de datos correspondiente. Haciendo clic en [Download] se muestran los datos de medición del fichero seleccionado en una tabla del formulario [Data].

Type	Date Time	Gas Type	Value	Unit	Alarm Type	X-zone ID
L	25.04.2014 07:43	O2	20,9	Vol%	OK	AREH-0008
L	25.04.2014 07:43	ch4	0	%UEG	OK	AREH-0008
L	25.04.2014 07:43	O2	20,9	Vol%	OK	AREH-0008
L	25.04.2014 07:43	ch4	0	%UEG	OK	AREH-0008
L	25.04.2014 07:43	O2	20,9	Vol%	OK	AREH-0008
L	25.04.2014 07:43	ch4	0	%UEG	OK	AREH-0008
L	25.04.2014 07:43	O2	20,9	Vol%	OK	AREH-0008
L	25.04.2014 07:43	ch4	0	%UEG	OK	AREH-0008
L	25.04.2014 07:44	O2	20,9	Vol%	OK	AREH-0008
L	25.04.2014 07:44	ch4	0	%UEG	OK	AREH-0008
L	25.04.2014 07:44	O2	20,9	Vol%	OK	AREH-0008

Figura 5.8: Vista en el visualizador de datos de la tabla de los juegos de datos de medición de un fichero de datos BSH cargado.

Significado de una columna dentro de la vista de la tabla:

Columna de la tabla	Valor	Significado
Tipo	L	Valor de medición local
	M	Valor máximo del gas en el grupo
	E	Error

Valor		Valor de medición de gas registrado
Unidad	Vol%, %UEG, %LEL, %LIE, ppm, mg/m3, ppb, mbar, hPa, kPa, mg/L	Unidades de valores de medición
Tipo de alarma	OK	Valor de medición en la gama normal
	A1	A1 Alarma
	A1_Q	A1 Confirmar alarma
	A2	A2 Alarma
	A2_Q	A2 Confirmar alarma
	Err	Fallo de aparato
	Err_Q	Confirmar fallo de aparato

Para la exportación de los juegos de datos a un fichero CSV, confirme con el botón [Save as]. Seguidamente seleccione el directorio donde deba memorizarse el fichero y decida si deben abrirse los juegos de datos del cálculo de tabla instalado en su ordenador.

Seleccione el formulario [Gerät] para poder ver las informaciones contenidas en el fichero de datos relativas al aparato, GPS, alarma y capacidades de batería.



Figura 5.9: Informaciones al X-zone Com en el momento de la transmisión del fichero BSH al formulario de vista sinóptica [Gerät] del visualizador de datos.

## 5.4 CONFIGURACIÓN DE X-ZONE COM

En la sección de configuración de la ventana se muestran los ajustes actuales del X-zone Com. Se ilustran a continuación cada uno de los formularios.

The screenshot displays the 'Manager Software' interface. At the top, there's a header with the 'manager software' logo. Below it, there are four main sections: 'Connection' (COM port, Disconnect button), 'Measuring Location' (ORI-Test\_7), 'Settings' (Upload, Download buttons), and 'History' (Open Log button). A red circle highlights the 'Device' tab, which is currently selected. Below the tabs, there are three main configuration areas: 'Device Date and Time' (30 Mai 2014 16:00:23, Set date/time from PC, UTC+02), 'Hardware info' (FW: 1.00 Z, Bat. FW: 00492649, ID: 00492649, Battery: 13.53 V), and 'Location' (Lat: 52.3542150N, Alt: 67 [meters], Active checkbox, Lon: 008.7308350E, #Sat: 5, Time of fix: 30.05.2014 15:42:26, Interval: 1 [hour]). Below these sections, a message states 'No X-zone is connected.' and a table displays gas measurements:

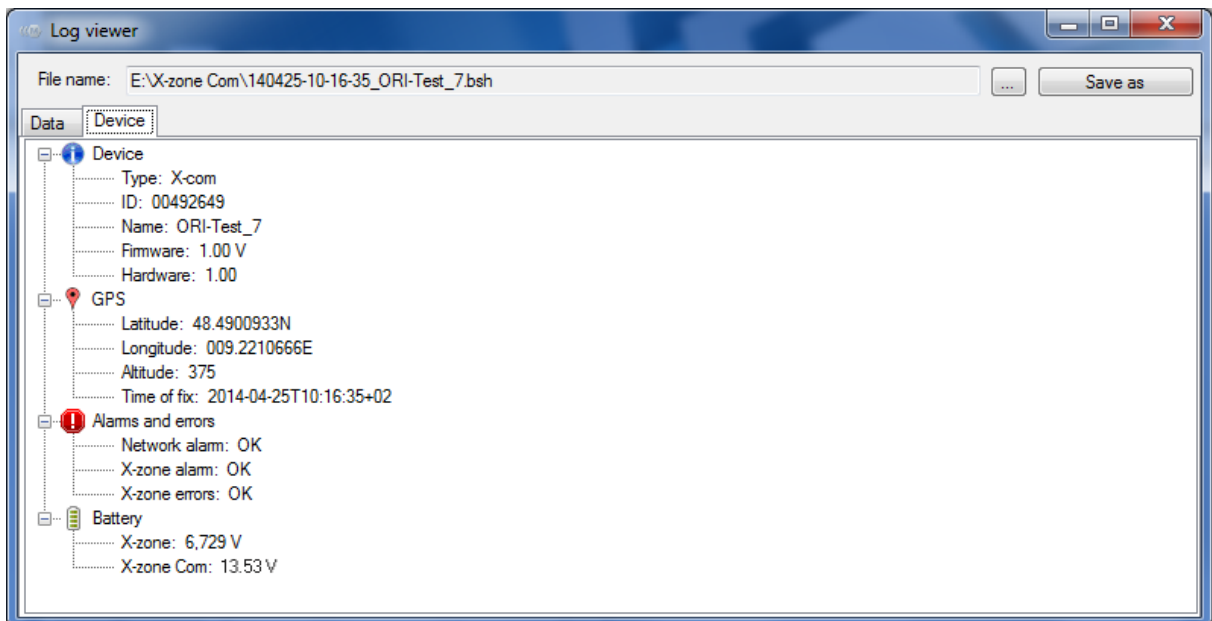
X-zone ID	GasType	Value	Unit	Alam Type
0	O2	20,9	Vol%	
0	H2S	0	ppm	
0	CO	0	ppm	
1	CO2	0,19	Vol%	
1	ch4	0	%LEL	

At the bottom right, it says 'Device connected -COM15 | Ver 1.0.16'.

Figura 5.10: Diversos formularios para ajustes generales, ajustes de registro de datos, GSM, e-mail y SMS.

Con excepción de la fecha y la hora del aparato todos los ajustes llevados a cabo deben transmitirse pulsando el botón [Upload] (en ajustes) al X-zone Com.

## 5.4.1 Formulario "aparato"

En el formulario "Gerät" ("aparato") pueden verse e introducirse valores de aparatos generales e informaciones.

Figura 5.11: Informaciones de aparatos generales como, por ejemplo la hora actual del aparato y las coordenadas GPS.

**Fecha / hora del aparato:** la hora mostrada se compone de "Universal Time Coordinated [UTC]" y la zona horaria, por ejemplo de Europa central:

1. Normal: UTC+1
2. Hora de verano: UTC+2

Haciendo clic en el botón [PC date/time] se escribe en el aparato la fecha y la hora actuales del ordenador. Se tiene en cuenta a este respecto la zona horaria seleccionada (UTC+1 hora en Europa central). Primeramente debe comprobarse la precisión de marcha del reloj del ordenador.

**INDICACIÓN**

*Tan pronto como se reciba una señal de GPS, se emplea la hora GPS.*

*En el caso de que el reloj no se encuentre ajustado, el cronomarcador se corresponde a la duración de funcionamiento desde la conexión del X-zone Com, si no se recibe la hora GPS.*

**Información:** la sección de informaciones muestra el número de la versión del firmware, el número de identificación así como el estado de carga actual del X-zone Com en voltios.

**Posición:** bajo "Location" ("Posición") puede ver los datos registrados relativos a la posición, la cantidad de los satélites GPS empleados así como cuándo fuera determinada o registrada la posición. Con "Interval" ("Intervalo") puede determinar en qué intervalos cronológicos haya de llevarse a cabo un nuevo registro de la posición GPS, en el ejemplo se hace cada hora (Figura 5.11). Un intervalo breve de GPS reduce la duración de funcionamiento de la batería.

Haciendo clic en el símbolo de la tarjeta se muestran con las coordenadas disponibles la posición del aparato en Google Maps. Se requiere para esto un browser instalado y conexión a Internet.

Figura 5.12: Intervalo según el cual se registra la posición.

## INDICACIÓN



El intervalo puede ajustarse entre 0 y 24 horas. Poniendo "0" se desactiva indefinidamente el módulo GPS.

Al conectar y con el intervalo ajustado el X-zone Com intentará determinar automáticamente las coordenadas GPS. Poniendo el gancho en el *checkbox* [Active], se inicia inmediatamente la fijación de la posición.

Location	
Lat: 52.3542150N	Alt: 67 [meters]
Lon: 008.7308350E	#Sat: 5
Time of fix: 30.05.2014 15:42:26	Interval: 1 [hour]

Figura 5.13: Iniciar una fijación inmediata de la posición marcando el checkbox.

Durante la determinación de la posición el color del escrito del *checkbox* [Active] cambia de gris a negro. Cuando se hayan determinado los parámetros GPS, se detiene este cambio de color y se muestran los datos de posición registrados. El *checkbox* [Active] se encuentra activado y se pone el momento de la fijación de la posición "Determined on" ("registrado en"). Ahora se intenta durante un minuto precisar el resultado. Después debe desactivar el checkbox [Aktiv] y el módulo GPS.

Cada intento de determinar una posición se interrumpe tras 10 minutos en caso de que no puede determinarse ninguna posición. Después el módulo GPS se desconecta a fin de ahorrar energía. Caso que no se hubiera podido determinar ninguna posición, la última que se hubiera podido determinar con éxito se sigue empleando. En la pantalla de la X-zone Com el símbolo GPS aparece rayado (véase capítulo 6.4.1).

## 5.4.2 Formulario de "registrador de datos"

El X-zone Com memoriza todos los valores de medición y resultados transmitidos por X-zone 5x00. Se puede configurar el intervalo en el que hayan de transmitirse los valores de medición.

## INDICACIÓN



Todos los ajustes llevados a cabo deben transmitirse haciendo clic en [Upload] al X-zone Com.

Figura 5.14: En el formulario "registrador de datos" se determina el intervalo de logging, pueden verse en la memoria de datos las informaciones de estado así como puede vaciar la misma memoria de datos.

**Intervalo:** en "Interval" se determinan los espacios cronológicos en los cuales se deban transmitir y memorizar los valores de medición. A este respecto pueden seleccionarse segundos (de 10 a 59 segundos) o minutos (de 1 a 60 minutos).

**Estado:** la cantidad de juegos de datos memorizados se representan en "total" y la cantidad de los juegos de datos aún no determinados en "unread" ("no leídos"). Además se muestra el nivel de ocupación de la memoria.

**INDICACIÓN**

*El registrador de datos se ha concebido en tanto memoria circular, es decir, cuando la memoria se encuentra llena, se sobrescriben automáticamente los juegos de datos más viejos.*

**Registrador de datos:** [Delete] vacía la memoria de datos del aparato. Antes del borrado definitivo se hace una pregunta de seguridad.

### 5.4.3 Formulario "GSM/GPRS"

Para una comunicación de datos de éxito a través de la red GSM/GPRS es necesario realizar diversos ajustes. Estos datos de comunicación dependen del proveedor de móvil empleado y deben ser consultados allí en caso de no ser conocidos.

**INDICACIÓN**

*Todos los ajustes llevados a cabo deben transmitirse haciendo clic en [Upload] al X-zone Com.*

Figura 5.15: Ajustes de móvil. Su proveedor de móvil le comunicará los ajustes válidos de la tarjeta SIM puesta. Haciendo clic en [Modem status] recibirá los parámetros de conexión; además se lleva a cabo una comprobación de la función.

<b>APN</b>	<p>Nombre Access Point de su ofertor de telefonía móvil, a introducir al poner una nueva tarjeta SIM</p> <p>Algunos ejemplo de puntos de acceso en Alemania (sin garantía)</p> <table border="1"> <thead> <tr> <th>Ofertor</th> <th>Puntos de acceso APN</th> <th>Usuario</th> <th>Contraseña</th> </tr> </thead> <tbody> <tr> <td>T-Mobile</td> <td>internet.t-mobile</td> <td>t-mobile</td> <td>tm</td> </tr> <tr> <td>Vodafone</td> <td>web.vodafone.de</td> <td>no necesario</td> <td>no necesario</td> </tr> <tr> <td>O2</td> <td>internet</td> <td>no necesario</td> <td>no necesario</td> </tr> <tr> <td>EPLUS</td> <td>internet.eplus.de</td> <td>eplus</td> <td>internet</td> </tr> </tbody> </table>	Ofertor	Puntos de acceso APN	Usuario	Contraseña	T-Mobile	internet.t-mobile	t-mobile	tm	Vodafone	web.vodafone.de	no necesario	no necesario	O2	internet	no necesario	no necesario	EPLUS	internet.eplus.de	eplus	internet
Ofertor	Puntos de acceso APN	Usuario	Contraseña																		
T-Mobile	internet.t-mobile	t-mobile	tm																		
Vodafone	web.vodafone.de	no necesario	no necesario																		
O2	internet	no necesario	no necesario																		
EPLUS	internet.eplus.de	eplus	internet																		
<b>Usuario</b>	nombre de usuario para su acceso de Internet																				
<b>Contraseña</b>	su contraseña para el acceso a Internet																				
<b>Tel.</b>	número de teléfono de la tarjeta SIM colocada. Entrada manual																				
<b>PIN</b>	número PIN de la tarjeta SIM colocada en el módem, caso que disponga de una protección de PIN. De lo contrario el casillero permanece vacío. Se necesita al conectar /iniciar el aparato.																				

Haciendo clic en [Modem status] se abre una ventana informativa y el módem intenta crear una conexión con la red.

Tan pronto como la dirección IP se muestre, se sabe que la comprobación de la función del módem ha sido positiva.





Figura 5.16: La ventana relativa al estado de módem le informa sobre los parámetros de conexión.

#### 5.4.4 Formulario "Email"

El X-zone Com envía cíclicamente de modo configurable e-mails con valores de medición. En caso de alarma tiene lugar el envío inmediatamente. En ambos casos se envían todos los valores de medición y de alarma aún no transferidos.

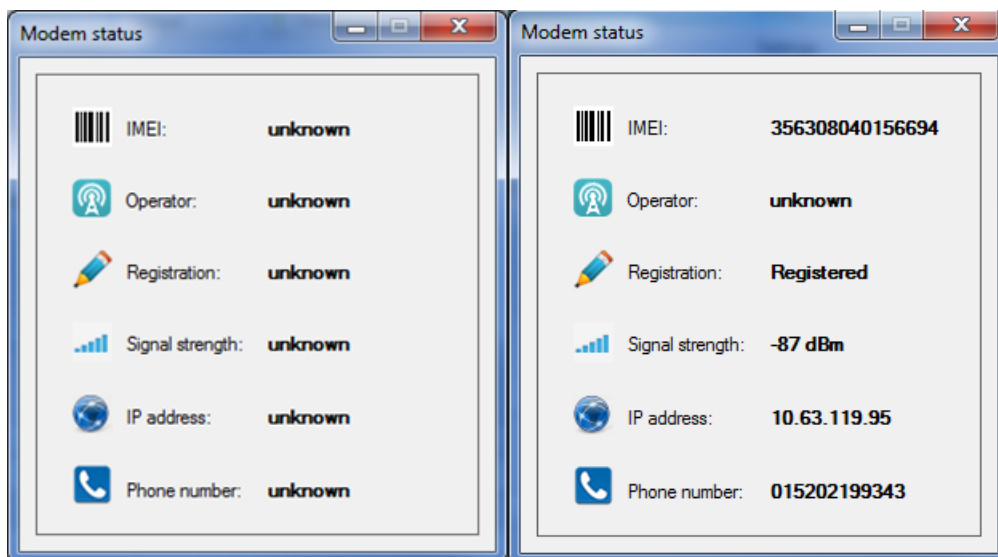

INDICACIÓN



Todos los ajustes llevados a cabo deben enviarse haciendo clic en [Upload] al X-zone Com.

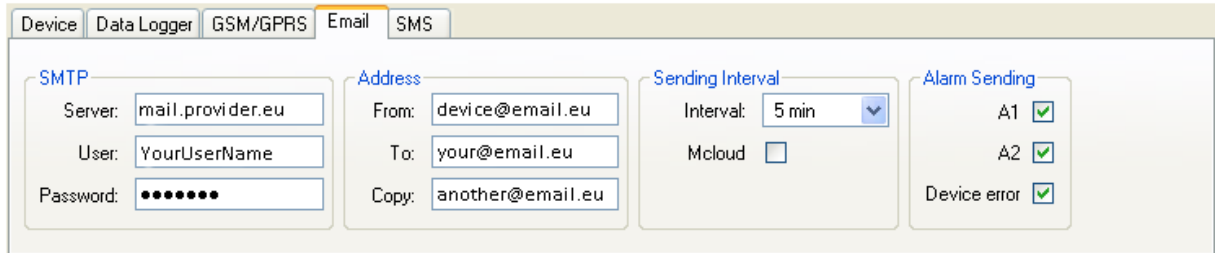

The screenshot shows a web interface for configuring email settings. It has tabs for 'Device', 'Data Logger', 'GSM/GPRS', 'Email', and 'SMS'. The 'Email' tab is active. Under 'SMTP', there are fields for 'Server' (mail.provider.eu), 'User' (YourUserName), and 'Password' (masked). Under 'Address', there are fields for 'From' (device@email.eu), 'To' (your@email.eu), and 'Copy' (another@email.eu). Under 'Sending Interval', there is a dropdown menu set to '5 min' and a checkbox for 'Mcloud'. Under 'Alarm Sending', there are three checkboxes: 'A1', 'A2', and 'Device error', all of which are checked.

Figura 5.17: Ajustes de e-mail como servidor SMTP, direcciones de emisión y recepción, intervalo de envío y relativos a los casos de alarma en que deban enviarse adicionalmente un e-mail.

**SMTP:** Los ajustes necesarios para el envío de e-mails y el empleo de Mcloud se llevan a cabo en "SMTP".

<b>Servidor</b>	dirección de su servidor de salida de correo
<b>Usuario</b>	nombre de usuario para el acceso de correo electrónico
<b>Contraseña</b>	su contraseña para el acceso de correo electrónico

**Dirección:** las direcciones de emisor y receptor se introducen en "Address".

<b>From: (De:)</b>	dirección del remitente (definida en relación al usuario según criterio del proveedor)
<b>To: (A:)</b>	receptor o destinatario de e-mail (máx. 1 destinatario).
<b>Copy: (Copia:)</b>	receptor o destinatario de e-mail (máx. 1 destinatario de la copia).

**Intervalo de envío:** bajo ("Sending Interval") ajusta el intervalo cronológico de los envíos (5/10/15/30 min; 1/2/3/4/6/8/12 h.; 1 día). Tras la memorización tiene lugar el primer envío de e-mail tras la conclusión del intervalo cronológico ajustado.

Con el marcado del checkbox "Mcloud" se transfieren los datos a Mcloud (véanse las instrucciones de servicio especiales para el empleo de Mcloud).

**Envío de alarmas:** bajo "Alarm Sending" puede configurar con qué condiciones de alarma deba activarse inmediatamente el envío de e-mails y la transmisión a Mcloud.

Compruebe los datos de provider y direcciones de recepción llevando a cabo una comprobación de función (véase capítulo 6.5). De este modo se activa inmediatamente el envío de un e-mail.

## 5.4.5 Formulario "SMS"

El X-zone Com puede configurarse de tal modo que en caso de alarma se envían SMS a números de teléfonos definidos según usuarios. Por lo demás el usuario tiene la posibilidad de preguntar vía SMS el estado actual así como enviar indicciones al X-zone Com (véase capítulo 7).

**INDICACIÓN**

Todos los ajustes llevados a cabo deben enviarse haciendose clic en [Upload] al X-zone Com.

Figura 5.18: Ajustes para el envío de SMS. Aquí determina Usted el contenido del SMS a enviar en caso de alarma. Completamente a la derecha ha de indicar el pin de "Read" ("Leer") y "Execute" ("Ejecutar").

En el formulario „SMS“ pueden determinarse una cantidad de hasta cuatro destinatarios de SMS que sean informados en caso de alarma. Para hacer un añadido haga clic en [Add] e introduzca el número. Con [Delete] se eliminan los números de teléfono marcados. Si se asigna un número, se encuentra la función de SMS suprimida. Por lo demás existe la posibilidad de determinar la cantidad máxima de SMS a enviar por día (1..99 SMS por día). Para esto ha de encontrarse marcado el checkbox [Max. Alarm/Day]. Caso que el checkbox se encuentre desactivado, la cantidad de mensajes SMS que pueden enviarse es ilimitada.

**Contenido de SMS:** bajo "Content" puede determinar la secuencia cronológica en tanto prefijo (no se admiten los signos: „§“, „°“, las metafonías de la lengua alemana y „ß“), que sigue al nombre del aparato en todos los SMS de alarma. Además puede elegir también si el actual valor de medición y el ID del X-zone 5x00 emisor de alarma se contengan en el SMS de alarma o sólo el tipo de alarma y la clase de gas.

**Alarm Sending:** con "Alarm sending" ("Enviar SMS en caso de") decide Usted, bajo qué condiciones de alarma se envía un SMS.

Tipo de alarma	Significado
<b>A1</b>	Alarma previa - concentración <b>Aspecto especial:</b> en el caso del tipo de gas O2 = carencia de oxígeno
<b>A2</b>	Alarma principal - concentración <b>Aspecto especial:</b> en el caso del tipo de gas O2 = oxígeno excedente
<b>Fallo de aparato</b>	Fallo de aparato en el X-am 5x00 o el X-zone 5x00. El aparato o varios canales de sensor no se encuentran dispuestos para el servicio. Fallo de aparato del X-zone Com anunciado, capítulo 10.1.

**INDICACIÓN**



Lea una vez más con exactitud el significado de los tipos de alarma en las instrucciones de servicio del X-am 5x00.

**PIN:** para la consulta vía SMS, que acepte como válida al X-zone Com, puede asignar Usted dos PIN. Estos tienen que encontrarse en el SMS a enviar el X-zone Com. Para acciones meramente de lecturas se contendrá el "Lesen-PIN" ("PIN de lectura"), para leer y demás acciones que, por ejemplo, influyan en la actual situación, tiene que contener el "Ausführen-PIN" ("PIN de ejecución"). El X-zone Com reacciona exclusivamente al SMS con el PIN correcto e ignora todos los demás. Una descripción detallada de los posibles SMS se encuentra en el capítulo 7.

Compruebe los números de teléfono introducidos en los que lleve a cabo la comprobación del funcionamiento (véase capítulo 6.5). Tan pronto como al menos con una de las tres condiciones de alarma deban enviarse un SMS, se activa inmediatamente el envío la alarma SMS con motivo de la comprobación de la función. Ejemplo de un mensaje de texto de alarma:





Figura 5.19: Ejemplo de una alarma SMS enviada. El X-zone Com "Test\_7" envía una alarma A2 en caso de CO2 y una alarma A1 en caso de oxígeno, medidos por el aparato de grupo X-zone con el ID 1.

**INDICACIÓN**

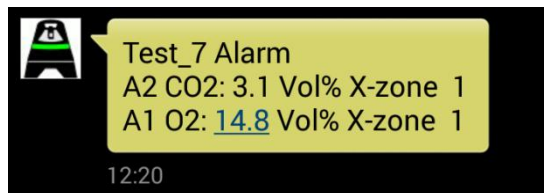

La respuesta SMS la recibirá sólo aquel usuario de SMS que haya enviado la consulta.

### 5.4.6 Formulario "Status"

El formulario „Status“ muestra el estado actual del hardware y el entorno funcional del X-zone Com conectado. El gancho verde señala la disponibilidad de servicio.



Figura 5.20: Disponibilidad de servicio íntegra del X-zone Com

En caso de fallo de error o fallo de aparato se señala esto por medio de una cruz roja. Haciendo clic en el signo + resaltado en la estructura de árbol se abre un mensaje detallado.

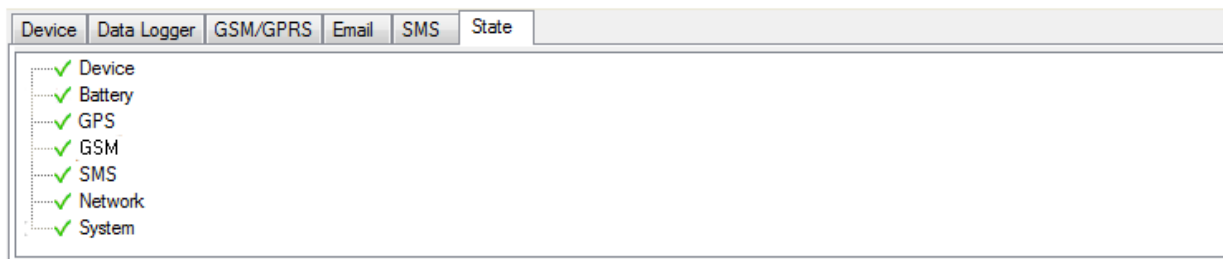

Figura 5.21: Se dan dos errores.

## 5.5 GAMA DE VALORES DE MEDICIÓN

La gama de valores de medición muestra los valores de medición y alarma actuales.

Aktuelle MAXIMALE Sensorwerte (das verbundene Gerät ist kein Master)				
X-zone ID	Gastyp	Wert	Einheit	Alarmtyp
0	O2	20,9	Vol%	A1
0	H2S	0	ppm	
0	CO	0	ppm	
0	CO2	0,25	Vol%	A2
0	ch4	0	%LEL	
1	ch4	0	%UEG	

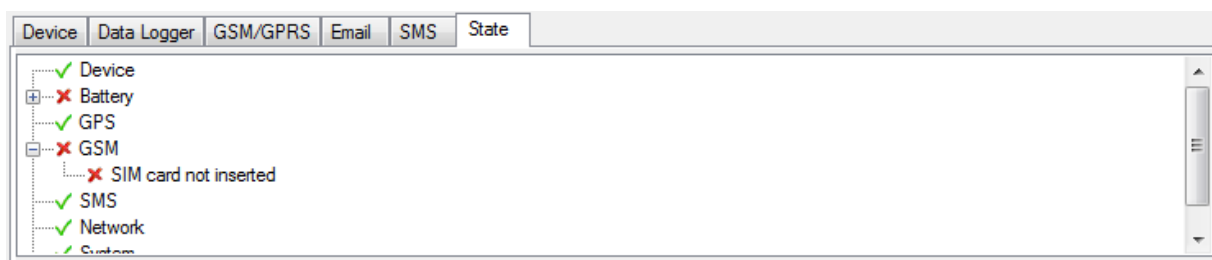
Figura 5.22: Valores de medición y alarma en la gama de valores de medición del Manager Software. La dos alarmas actuales se han disparado por el aparato de grupo 0.

La tabla muestra por cada valor de medición el número de identificación del X-zone 5x00 en el grupo, la clase de gas, la concentración actual de gas y la unidad así como la clase de alarma caso que se dé una alarma.

Del texto que se encuentra por encima de la tabla puede consultarse si el X-zone 5x00 conectado es parte de una red abierta o cerrada (grupo) y si el valor de medición, por ende, es un valor local o un valor máximo del grupo (véase capítulo 4.2.4).

Vista sinóptica	Significado
Valores LOCALES y actuales de sensor (no se ha configurado ningún grupo cerrado)	<b>Red abierta:</b> se muestran los valores de sensor del X-zone 5x00 conectado localmente al X-zone Com.
El valor de sensor actual MÁXIMO de sensor (el aparato conectado no es un master)	<b>Grupo:</b> máximos valores de medición de las clases de gas medidas actualmente en la red
Valores de sensor actuales MÁXIMOS	<b>Grupo:</b> valores de medición máximos de las clases de gas actualmente medidas en la red
No conectado con el X-zone 5x00	Sin conexión al X-zone

## 6 MANEJO DEL X-ZONE COM

En adelante se ilustra el manejo del X-zone Com.

### 6.1 GAMPO DE USUARIO

El X-zone Com dispone de una pantalla OLED en la que se representan las informaciones más importantes y dos teclas con barrita magnética para los usuarios.



Figura 6.1: Campo de usuario de X-zone Com

Las teclas están asignadas de la siguiente manera:

	Tecla <b>ON/OFF</b> para conectar y desconectar el aparato	<b>Pulsación prolongada</b> ON (aprox. 3 segundos) OFF (aprox. 3 segundos) <b>Toque breve:</b> regreso a la visita sinóptica
	<b>Tecla funcional</b>	<b>Pulsación prolongada</b> lleva a cabo la comprobación de la función <b>Toque breve</b> conmuta a la próxima página de pantalla cuando se da un error. Durante la comprobación funcional se concluye este mismo proceso con un toque breve.

### 6.2 CONECTAR EL APARATO

Para conectar el X-zone Com, accione la tecla izquierda (ON/OFF) con la barrita magnética durante unos 3 segundos. En la pantalla se cuenta descendentemente de 3 a 1.



Figura 6.2: Cuenta descendente al conectar.

**CUIDADO**

El X-zone Com solamente debe funcionar en la gama de temperatura indicada.

Al conectar, el X-zone Com intentará acceder automáticamente a la red GSM y determinar las coordenadas GPS. Con la batería agotada no puede conectarse el X-zone Com.

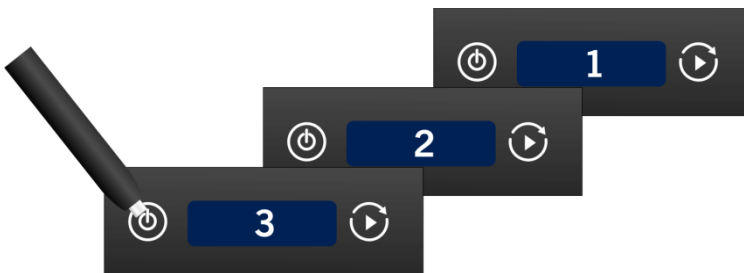
Caso que el módem no cuente con una tarjeta SIM se genera el mensaje de error x21 „no SIM card“.

## 6.3 DESCONECTAR EL APARATO

Para desconectar el X-zone Com, accione la tecla izquierda (ON/OFF) con la barra magnética durante unos 3 segundos. En la pantalla se cuenta entonces descendentemente de 3 a 1.



Figura 6.3: Cuenta descendente al desconectar.

En caso de que la batería se encuentre agotada, el X-zone Com se desconecta automáticamente.

## 6.4 VISUALIZACIONES DE PANTALLA

La visualización de la pantalla se divide en dos zonas.

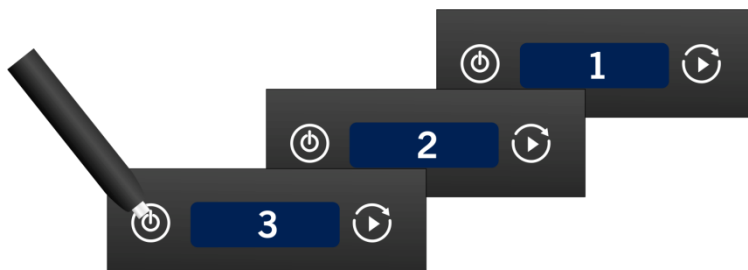
- Zona izquierda: señalización de estado de funciones o acciones individuales.
- Zona derecha: señalización de estado total.



Figura 6.4: Visualización de pantalla en el X-zone Com.











### 6.4.1 Vista sinóptica de símbolos

El Estado total se describe por medio de los siguientes símbolos.

Símbolo	Significado	Símbolo	Significado
	Actualmente no se dan errores. Todas las acciones de la comprobación del funcionamiento han concluido con éxito.		Estado de la última acción: X-zone Com, tuvo lugar un fallo de aparato.
	Al menos una acción en proceso (por ejemplo, creación de una conexión, envío de SMS, determinación de la posición).		

Los significados de los símbolos de las funciones individuales se ilustran en la siguiente tabla.

Símbolo	Significado	Símbolo	Significado
---------	-------------	---------	-------------

	¡Transmisión de datos a ORI Mcloud activada! <b>Parpadeante:</b> se envían los datos.		
	Activado el envío de e-mail a un receptor al menos. <b>Parpadeante:</b> se envía un e-mail.		Envío de e-mail y transmisión a Mcloud no posible / interrumpido.
	SMS enviado con éxito / activado. <b>Parpadeante:</b> se envía SMS.		El SMS no pudo enviarse.
	Batería completamente cargada. <b>Carga de la batería en aumento cíclica en la pantalla:</b> batería cargándose.		Batería agotada; el aparato puede desconectarse en todo momento.
	Posición GPS transmitida con éxito. <b>Parpadeante:</b> determinación de las coordenadas.		Sin GPS (desconectado o recepción no posible).
	Intensidad de señal aprox. 100%.		
	Intensidad de señal aprox. 20%. <b>Parpadeante:</b> registro en la red GSM actualmente activo.		Sin conexión a la red GSM.

**Ejemplo:**

1.		La batería se encuentra aún cargada al 75 % aproximadamente, la intensidad de la señal es del 100% aproximadamente, la conexión a Mcloud y las funciones de e-mail se encuentran activas, las coordenadas de GPS han sido determinadas. El estado total es en orden.
----	---	--



### 6.4.2 Señalización de errores

En la pantalla pueden señalizarse diversos errores. En el capítulo 10.1 se encuentra una tabla de errores. Contiene una descripción y un consejo relativo al modo de proceder para cada uno de los errores. Accionando la tecla derecha se pasa de una señalización de error a otra.



Figura 6.5: Ejemplo de un error con número de error y descripción breve

**Ejemplos:**

	El SMS y el email no se han enviado durante la comprobación del funcionamiento. El envío de datos a Mcloud no se encuentra activado en este ejemplo. <b>Posibles causas:</b>
	
	<ul style="list-style-type: none"> <li>Número de teléfono no válido</li> </ul>

- Dirección de e-mail errónea en "to" y "copy to"

## 6.5 EJECUCIÓN DE LA COMPROBACIÓN DEL FUNCIONAMIENTO

La comprobación del funcionamiento tiene el cometido de comprobar los ajustes de envío y recepción y la aptitud de funcionamiento del X-zone Com así como comprobar la recepción de GSM y GPS. Además se inicia con ella inmediatamente una determinación o localización de la posición.

La comprobación del funcionamiento se activa accionando la tecla de usuario derecha  (3 segundos) del X-zone Com. Se llevan a cabo entonces las siguientes funciones:

- Activación de GPS, determinación de las coordenadas y la hora.
- Acceso o registro del módem a la red inalámbrica, crear el acceso APN, determinar la dirección IP.
- Enviar e-mails a destinatarios de e-mail inscritos con todos los datos no enviados hasta ese momento.
- Transmitir todos los datos aún no enviados a Mcloud si la función Mcloud se encontrara activada.
- Envío de un SMS a todos los números de teléfono inscritos toda vez que al menos se dé una condición de alarma y haya de enviarse un SMS.

Las informaciones de estado se muestran en la pantalla (envío de SMS, e-mail y Cloud, determinación de la posición). Mientras una acción no concluya, parpadea el símbolo.

Caso que se den errores, se muestra en la zona derecha de la pantalla el símbolo de error correspondiente. Demás informaciones sobre los errores pueden consultarse en el Manager Software, en el formulario "State" ("Estado") (capítulo 5.4.6).



Si se han enviado SMS y e-mails y la posición se hubiera determinado con éxito, aparece la imagen de pantalla representada a la izquierda.

Accionando el botón izquierdo la visualización se conmuta de nuevo a la pantalla de estado.

### INDICACIÓN



*Durante la comprobación del funcionamiento la tecla de usuario izquierda del X-zone Com se encuentra limitada. Entonces sólo es posible desconectar el aparato con ella.*



## 7 SMS AL X-ZONE COM

El X-zone Com ofrece al usuario la posibilidad de consultar vía SMS el estado actual así como enviar instrucciones al X-zone Com. Al hacer una consulta vía SMS debe emplearse la siguiente estructura.

[PIN] Comando

El [PIN] a introducir (personal identification number) consiste en el "Lesen-PIN" ("PIN de lectura") asignado en el Manager Software para leer o bien en el "Ausführen-PIN" ("PIN de ejecución") para leer y demás acciones que, die por ejemplo, influyen en la situación actual (véase capítulo 5.4.5). El PIN evita que un SMS de no autorizados sea aceptado por el X-zone Com.

Una introducción errónea de PIN genera un mensaje de error directamente en el aparato. En este caso no hay ninguna respuesta vía SMS.



Figura 7.1: Mensaje de error en el aparato al emplearse un PIN de SMS erróneo.

El comando puede escribirse en mayúsculas o minúsculas. Está autorizado el empleo del signo de interrogación junto al comando.

Las respuestas vía SMS se ilustran en detalle en los siguientes apartados.

PIN	Comando	Respuesta
<b>[PIN de lectura]</b>	Stat	Informaciones relativas al aparato
	Group	Información relativa al grupo
	Local	Valores de medición locales del X-zone 5x00 directamente conectado al X-zone Com
	Max	Valores máximos de los gases medidos en la red cerrada
	Alarm	Actuales valores de alarma
<b>[PIN de ejecución]</b>	Ack	Confirmación de alarma
	Evac	Alarma de evacuación conec.
	Evac off	Alarma de evacuación desconec.
	GPS	Últimas cordinadas GPS conocidas

## 7.1 ÓRDENES SMS A LEER

Las órdenes SMS a leer pueden transmitirse con el "Read-PIN" ("PIN de lectura") o con el "Execute-PIN" ("PIN de ejecución").

### 7.1.1 Pregunta de estado

#### [PIN] stat

Contenido del SMS de respuesta	Gama de valores
Nombre del aparato del X-zone Com	Secuencia de signos ASCII definidos según usuario
Estado de conexión al X-zone 5x00	"X-zone connected" "X-zone not connected"
Nivel GSM RSSI [-dBm]	de -100 a 0
Tensión de batería del X-zone Com [V]	de 12 a 13,5 V (máx. 15V)
Tensión de batería del X-zone 5x00 [V]	de 5 a 7 V
Empleo de e-mail de alarma	ON/OFF
Intervalo de envío ajustado para e-mails y transmisión de datos a Mcloud	5/10/15/30 min.; 1/2/3/4/6/8/12 horas;. 1 día

Ejemplo:



Figura 7.2: Vista de la pantalla de un Smartphone tras la consulta de estado vía SMS.

**A)** Respuesta al no darse conexión al X-zone 5x00.

**B)** Respuesta al darse conexión al X-zone 5x00.

Los modos de escritura diferentes del comando están autorizados.

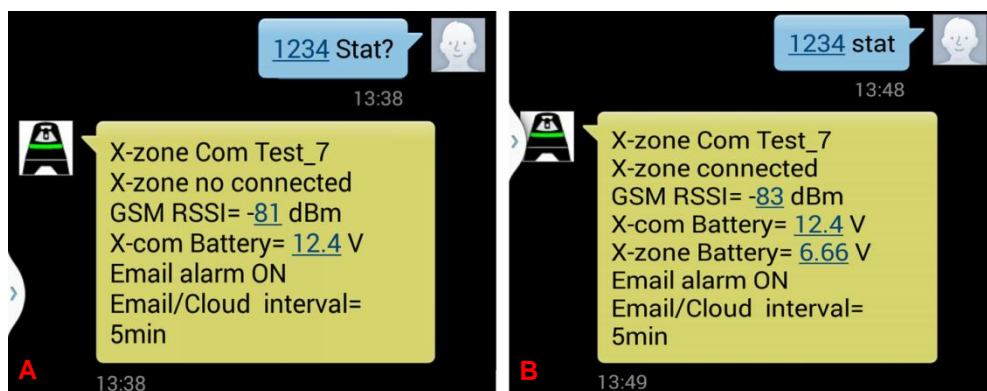
## 7.1.2 Consulta de informaciones sobre el estado del grupo

Con el comando "group" ("grupo") pueden consultarse informaciones sobre le grupo de aparatos o un aparato no agrupado en una red abierta.

### [PIN] group

Contenido del SMS de respuesta	Gama de valores
Nombre de aparato del X-zone Com	Secuencia de signos ASCII definidos según usuario
Estado del grupo del aparato	„Main device“ „group device“ „ungrouped“
Tamaño del grupo, en la medida en que esté conectado al aparato principal	de 2 a 15
Estado de alarma	No alarm, A1, A2, device error
Cantidad de los gases vigilados (del grupo o del X-zone 5x00 conectado localmente)	de 0 a 8

### Ejemplo: respuesta en el caso de un grupo



Figura 7.3: Vista de pantalla de un Smartphone tras la consulta del estado de grupo.

**A)** El aparato que responde consiste en un aparato principal (ID=0). El grupo consta de dos aparatos y vigila en total 4 gases. Se da una alarma A1.

**B)** El X-zone Com se encuentra conectado al aparato de grupo con ID 1. Del grupo se vigilan en total 6 gases. No se da una alarma.

### Ejemplo: respuesta de un aparato local

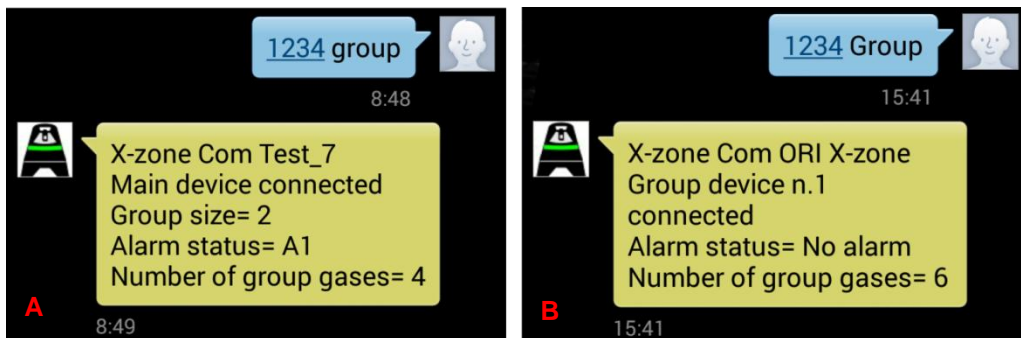

Figura 7.4: El aparato que responde es un aparato local no agrupado que vigila un total de tres gases.

### 7.1.3 Valores de medición X-zone 5x00 conectado localmente

Con la pregunta SMS "Local" se transmiten los valores de medición actuales del X-zone 5x00 directamente conectado con el X-zone Com al margen de que sea parte de un grupo o no.

#### [PIN] local

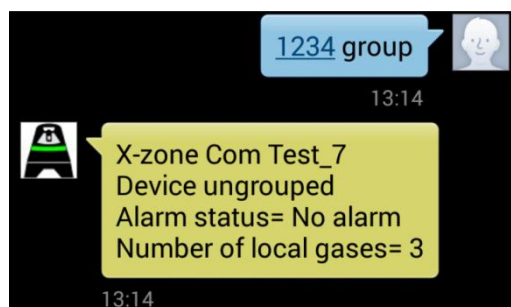
Contenido del SMS de respuesta	Gama de valores
Nombre de aparato del X-zone Com	Secuencia de signos ASCII definidos según usuario
Tipo de gas	Nombre breve del gas del X-am 5x00
Valor de la concentración	de 0 a 10.000
Unidad	Vol%, %UEG, %LEL, %LIE, ppm, mg/m3, ppb, mbar, hPa, kPa, mg/L
Tipo de alarma	A1, A2
Número de identificación	Número de serie del X-zone 5x00

Ejemplo:



Figura 7.5: Vista de pantalla de un Smartphone tras el envío de "1234 local". En el ejemplo el X-zone "AREH-0003" conectado con el X-zone Com "ORI X-zone" mide 5 gases. Respecto de CO<sub>2</sub> se da una alarma A2, respecto de für O<sub>2</sub> una alarma A1.

### 7.1.4 Pregunta de los valores de medición máximos en un grupo

El X-zone Com transmite una lista que contiene el valor máximo actualmente medido relativo a cada uno de los gases medidos del grupo incluyendo un tipo de alarma eventualmente disponible y la identificación (ID) de aparatos. El valor mostrado del oxígeno es el valor mínimo.

#### [PIN] máx

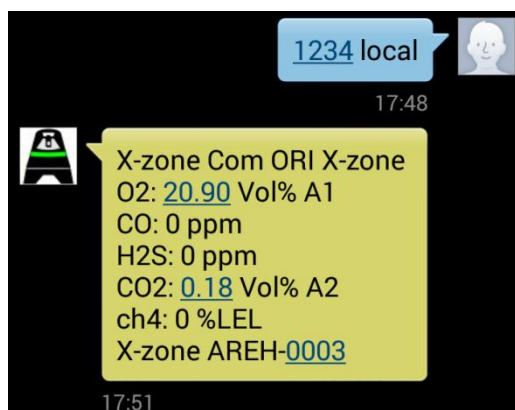
Contenido del SMS de respuesta	Gama de valores
Nombre de aparato del X-zone Com	Secuencia de signos ASCII definidos según usuario
Tipo de gas	Nombre breve del gas del X-am 5x00
Valor de la concentración	de 0 a 10.000
Unidad	Vol%, %UEG, %LEL, %LIE, ppm, mg/m <sup>3</sup> , ppb, mbar, hPa, kPa, mg/L
Tipo de alarma	A1, A2
Número de identificación del X-zone 5x00 en el grupo que haya medido el valor máximo	de 0 a 15

#### Ejemplo: valores máximos



Figura 7.6: Imagen de pantalla de un Smartphone tras la consulta de todos los valores máximos de los gases vigilados del grupo. En el ejemplo se mide el valor ch4 del aparato de grupos con ID=1. El resto de los gases del aparato principal con el ID=0. Respecto de O<sub>2</sub> y CO<sub>2</sub> se dan correspondientemente las alarmas A1 y A2.



Figura 7.7: Imagen de pantalla de un Smartphone, en el caso de que el X-zone 5x00 conectado no sea ningún aparato de grupo. Sírvase en este caso de la orden "local".

## 7.1.5 VISUALIZAR LAS CORDENADAS GPS

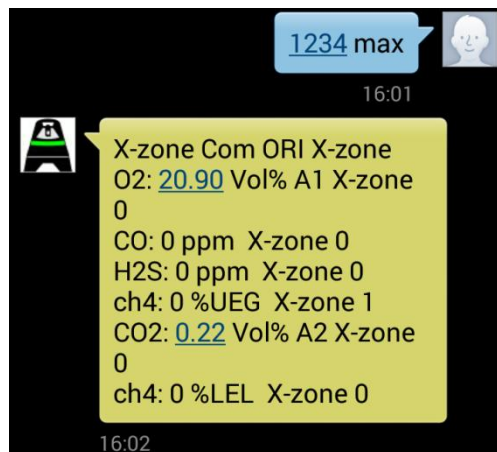
El SMS de respuesta contiene la última posición conocida del X-zone Com.

### [PIN] GPS

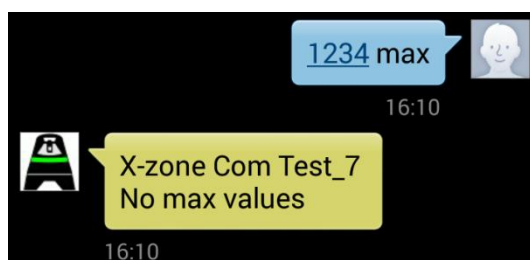
Contenido del SMS de respuesta	Gama de valores
Nombre de aparato del X-zone Com	Secuencia de signos ASCII definidos según usuario
Cordenadas	Grado de latitud, grado de longitud
Altura	Altura aproximada sobre el nivel del mar (Mean Sea Level)
Fecha y hora de la última determinación con éxito de la posición	Fecha y hora

La hora indicada se compone del "Universal Time Coordinated [UTC]" y de la divergencia cronológica local, por ejemplo en Europa Central:

- Normal: UTC+1
- Horario de verano: UTC+2

Ejemplo:



Figura 7.8: Imagen de pantalla de un Smartphone tras la consulta de la posición. En el ejemplo se determinaron las coordenadas por última vez a la hora local 08:05 (UTC+1). La consulta de SMS se realizó a la hora local 09:18.

## 7.1.6 Consulta de las alarmas actual

Se remite una lista de las alarmas actuales. La lista puede contener alarmas de gases y fallos de aparato. Con la alarma de gas se transmiten las siguientes indicaciones: tipo de gas activadores de la alarma, el valor de medición actual y la unidad así como en qué X-zone 5x00 se da la alarma. Con motivo de fallo de aparatos se transmite en qué X-zone 5x00 se encuentra el error pero ningún código de error.

La estructura de la respuesta SMS depende de los ajustes que haya llevado Usted a cabo en el Manager Software.

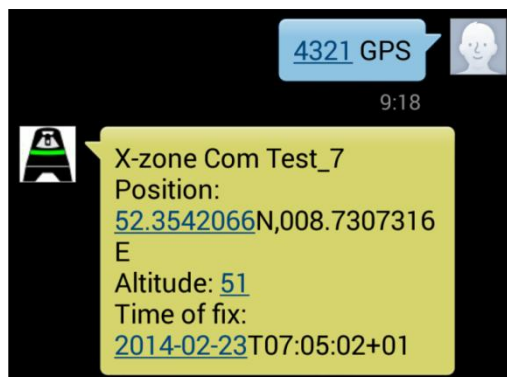
Figura 7.9: Determinación de la estructura de respuesta de SMS dentro del Manager Software.

### [PIN] Alarma

En caso de una alarma de gas (A1, A2)

Contenido del SMS de respuesta	Gama de valores
Nombre de aparato del X-zone Com	Secuencia de signos ASCII definidos según usuario
Prefijo	Secuencia de signos ASCII definidos según usuario
Tipo de alarma	A1, A2
Tipo de gas	Nombre breve del gas del X-am 5x00
Valor de la concentración (optativa)	de 0 a 10.000
Unidad (optativa)	Vol%, %UEG, %LEL, %LIE, ppm, mg/m <sup>3</sup> , ppb, mbar, hPa, kPa, mg/L
ID del X-zone 5x00 (optativa)	de 0 a 15 el número de serie del X-zone 5x00

En caso de fallo de aparatos de X-zone 5x00

Contenido del SMS de respuesta	Gama de valores
Nombre de aparato del X-zone Com	Secuencia de signos ASCII definidos según usuario

Prefijo	Secuencia de signos ASCII definidos según usuario
Tipo de alarma	"Device alarm"
ID del X-zone 5x00 (optativa)	de 0 a 15 o el número de serie del X-zone 5x00

### Ejemplos: Alarmas



Figura 7.10: Imagen de pantalla de un Smartphone tras una pregunta de alarma. Se pregunta el "Test\_7" del X-zone Com. Se da una alarma A1 en caso de oxígeno. El siguientes valor de oxígeno consiste en el valor O2 actualmente medido, no en el valor que ha llevado a la alarma

La alárma se activó

- A. por el "X-zone 0" (0=aparato principal)
- B. por el "X-zone 1" (1=aparato de grupo).

#### INDICACIÓN

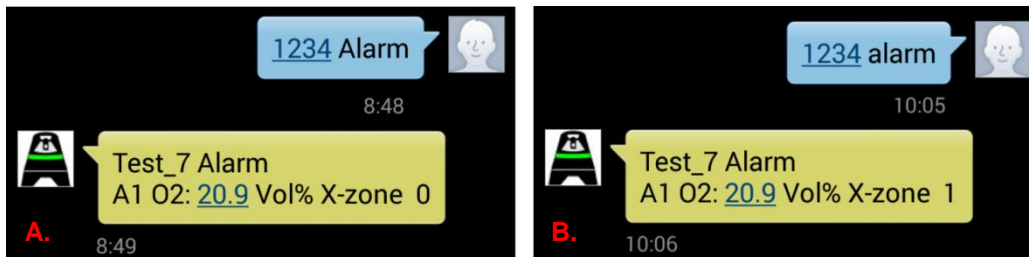

En el caso de una alarma anteriormente confirmada recibirá al enviar el PIN de orden de alarma el mensaje "All alarms stopped".



## 7.2 ÓRDENES SMS A EJECUTAR

**INDICACIÓN**

 Necesita el "Execute-PIN" determinado en el Manager Software para las órdenes SMS a ejecutar.

### 7.2.1 Confirmación de alarma

El comportamiento del X-am 5x00 en el caso de una confirmación de alarma depende de su configuración. Las alarmas pueden ser confirmables o no confirmables o automantenibles o no automantenibles. Por este motivo, por favor, lea a fondo e íntegramente las instrucciones de servicio de su aparato de medición de gases Dräger X-am 5x00.

**INDICACIÓN**

 Una confirmación de todas las alarmas no tiene necesariamente como consecuencia el que dejen de señalizarse alarmas. El comportamiento del sistema depende de la situación de alarma y de la configuración del X-am 5x00.

La respuesta SMS contiene, además del nombre de aparato del X-zone Com, un texto que comunica el que las alarmas hayan sido confirmadas.

#### [Execute-PIN] ack

Contenido del SMS de respuesta	Gama de valores
Nombre de aparato del X-zone Com	Secuencia de signos ASCII definidos según usuario
Texto de confirmación	"Alarms acknowledged"

**Ejemplo:**



Figura 7.11: Imagen de pantalla de un Smartphone tras enviar la confirmación de alarma.

### 7.2.2 Activar la alarma de evacuación

El usuario, con un SMS, puede activar una alarma que es señalizada por la red del X-zone 5x00 en tanto alarma A2. Esta alarma se llama „de evacuación“, ya que normalmente tiene el cometido de evacuar una zona.

## [Execute-PIN] evac

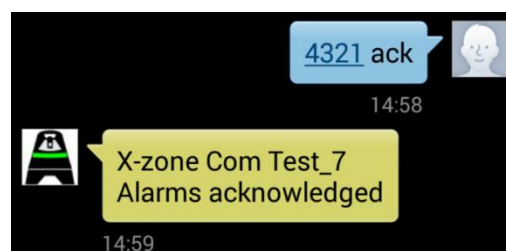
Contenido del SMS de respuesta	Gama de valores
Nombre de aparato del X-zone Com	Secuencia de signos ASCII definidos según usuario
Texto de confirmación	“Evacuation alarm”

Ejemplo:





Figura 7.12: Imagen de pantalla de un Smartphone después de que una alarma de evacuación haya sido activada.

INDICACIÓN

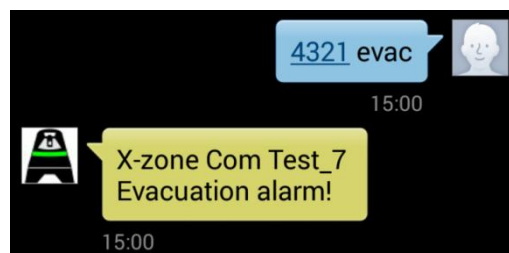

En el caso de una alarma de evacuación aparecen en todos los X-am 5x00 del grupo un símbolo de evacuación en la pantalla.

## 7.2.3 Concluir la alarma de evacuación

La alarma de evacuación puede concluirse vía SMS o desconectando el X-zone Com.

## [Execute-PIN] evac off

Contenido del SMS de respuesta	Gama de valores
Nombre de aparato del X-zone Com	Secuencia de signos ASCII definidos según usuario
Texto de confirmación	“Evacuation alarm stopped”

Ejemplo:



Figura 7.13: Imagen de pantalla de un Smartphone después de que la alarma de evacuación haya sido repuesta.

## 8 VISTA SINÓPTICA MCLLOUD

Se ilustran brevemente en este capítulo la funcionalidad de ORI Mcloud y su empleo. Encontrará informaciones detalladas de ORI Mcloud en el manual correspondiente.

Mcloud es un portal de datos de Internet, en el que puede preguntar y representar los datos de su X-zone Com por medio de su browser de WEB. Además del estado de aparato general, el estado de carga de la batería y el último momento de envío, verá todos los valores de procesos de medición y valores de alarma. El espacio cronológico para las series de medición puede seleccionarse. Los datos representados gráficamente puede exportarlos Usted en un fichero CSV y descargarlos en su ordenador, donde puede abrir y seguir procesando los ficheros, por ejemplo, con Microsoft Excel. Por lo demás puede dejar representar en una tarjeta la posición de sus aparatos de X-zone Com.

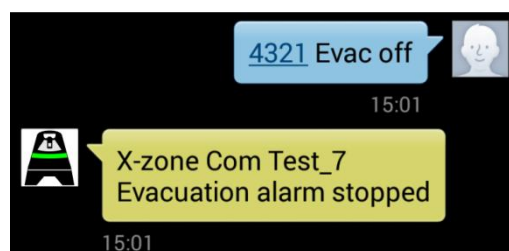
Para el acceso a Mcloud necesita una conexión a Internet, un browser de WEB y, después de transcurrir cuatro semanas, una licencia que debe adquirir para cada aparato. Las primeras semanas gratuitas para Usted comienzan tan pronto como registre el aparato. Después de transcurrir este tiempo puede adquirir las licencias temporalmente limitadas. Si la licencia de un X-zone Com es válida, puede memorizarse cualquier cantidad de valores de medición. Antes de concluir la vigencia de una licencia se le indicará esto mismo a tiempo por medio de un símbolo de aviso dentro de la lista de aparatos.

Los datos de su Ihres X-zone Com se almacenan en Alemania en un servidor comprobado por TÜV según "Trusted Site TSI V3.0 Level 1". El acceso vía browser se encuentra protegido por contraseña y se realiza a través de un protocolo de transferencia de hipertexto seguro HTTPS.

### 8.1 LISTA DE APARATOS MCLLOUD

En la lista de aparatos se muestran todos los aparatos registrados. Caso que su aparato no se muestre, debe registrarse en Mcloud (véase Figura 8.2). El registro sólo es posible, si su aparato previamente ha realizado mínimamente un envío. Para transferir los datos de medición a Mcloud, no debe olvidar, pues, que debe activar la funcionalidad de Cloud por medio del Manager Software (véase capítulo 5.4.4).

Home List of devices Map All measured values

REGISTER DEVICE

In order for your device data can be stored in Mcloud, you must register the device. Please fill out the following form and click 'Register'. The registration is only possible if your device has previously sent data at least once.

Register device

Device-ID (Hex-Format):



Device-name (the same with location):

Xcom

Register

Figura 8.1: Requerimiento de registro de Mcloud de ORI.

Respecto de cada X-zone Com registrado verá:

- **1** los ID de aparatos,
- **2** el último lugar de medición (el nombre de aparato dado por el usuario sirviéndose del Manager Software),
- **3** cuándo haya hecho el aparato un envío por última vez,
- **4** estado de envío  = actualmente activo;  = inactivo durante un plazo prolongado de tiempo (a partir de 24 horas).

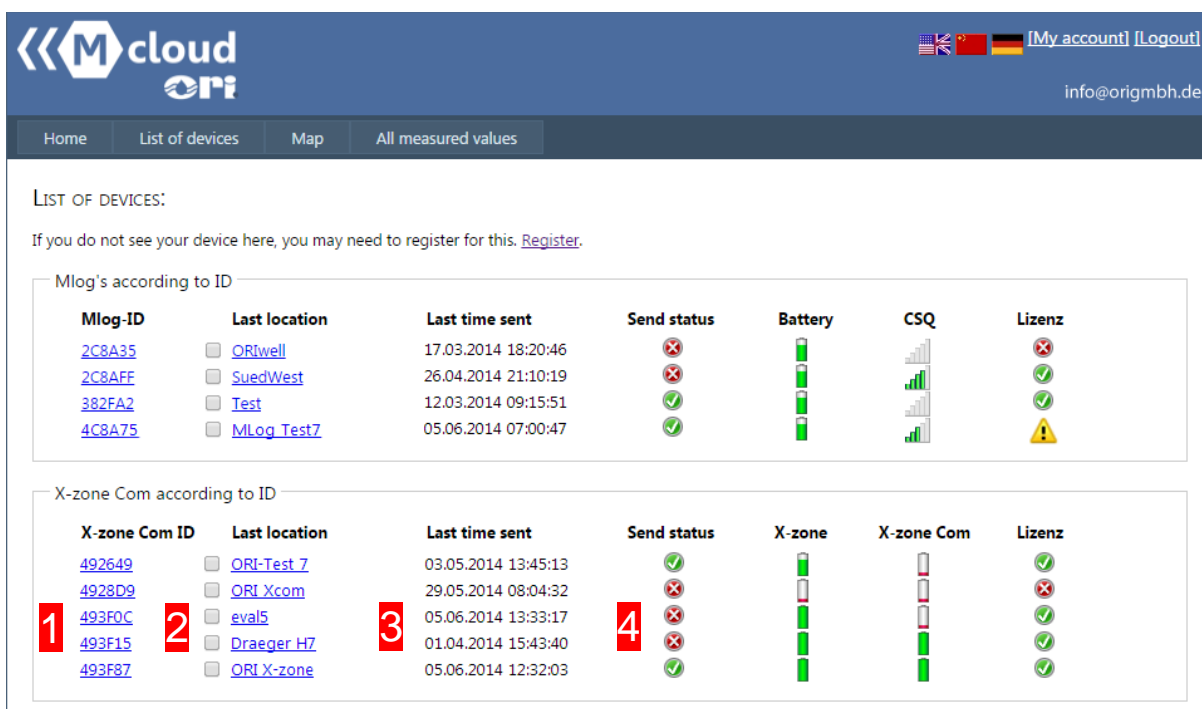

The screenshot shows the Mcloud ori web interface. At the top, there is a navigation bar with 'Home', 'List of devices', 'Map', and 'All measured values'. Below this, there is a section titled 'LIST OF DEVICES:' with a link to 'Register' if a device is not visible. The main content is divided into two sections: 'Mlog's according to ID' and 'X-zone Com according to ID'. The 'Mlog's' table has columns for Mlog-ID, Last location, Last time sent, Send status, Battery, CSQ, and Lizenz. The 'X-zone Com' table has columns for X-zone Com ID, Last location, Last time sent, Send status, X-zone, X-zone Com, and Lizenz. Red boxes with numbers 1, 2, 3, and 4 highlight specific data points in the X-zone Com table.

Mlog-ID	Last location	Last time sent	Send status	Battery	CSQ	Lizenz
<a href="#">2C8A35</a>	<input type="checkbox"/> ORIwell	17.03.2014 18:20:46				
<a href="#">2C8AFF</a>	<input type="checkbox"/> SuedWest	26.04.2014 21:10:19				
<a href="#">382FA2</a>	<input type="checkbox"/> Test	12.03.2014 09:15:51				
<a href="#">4C8A75</a>	<input type="checkbox"/> MLog_Test7	05.06.2014 07:00:47				

X-zone Com ID	Last location	Last time sent	Send status	X-zone	X-zone Com	Lizenz
<a href="#">492649</a>	<input type="checkbox"/> ORI-Test 7	03.05.2014 13:45:13				
<a href="#">4928D9</a>	<input type="checkbox"/> ORI Xcom	29.05.2014 08:04:32				
<b>1</b> <a href="#">493F0C</a>	<b>2</b> <input type="checkbox"/> eval5	<b>3</b> 05.06.2014 13:33:17	<b>4</b>			
<a href="#">493F15</a>	<input type="checkbox"/> Draeger H7	01.04.2014 15:43:40				
<a href="#">493F87</a>	<input type="checkbox"/> ORI X-zone	05.06.2014 12:32:03				

Figura 8.2: Lista de todos los aparatos registrados así como el enlace del registro de los aparatos.

En las demás columnas se representan informaciones adicionales relativas a los aparatos por medio de símbolos, en un X-zone Com, por ejemplo, la propia capacidad de la batería y la capacidad de la batería del X-zone 5x00 conectado.

Capacidad de la batería (%)	CSQ (%) Intensidad de la señal	Estado de la licencia
aprox. 75-100%	aprox. 100%	Licencia válida
aprox. 50-75%	aprox. 80%	La licencia vence en breve
aprox. 30-50%	aprox. 60%	La licencia ha vencido
aprox. 15-30%	aprox. 40%	
< 15%	aprox. 20%	
	ninguna señal	

## 8.2 ESTADO DE APARATO MCLLOUD

Haciendo una vez clic en el ID de aparato (1) contará con informaciones detalladas relativas al aparato. Aquí pueden activarse para más seguridad la vigilancia del intervalo de envíos del aparato. A este respecto ha de introducir en "Monitoring time transmission interval" ("Tiempo de vigilancia del intervalo de envío") (en minutos) el ciclo de envíos asignado en el Manager Software. Entonces se comprueba si los envíos del aparato al Cloud se realizan según estos intervalos. Si no fuera éste el caso, se activa la alarma de intervalo de envío.

X-ZONE COM

Here you can see the current status and parameter values of the last episode of your X-zone Com. In addition, you can also renew the license of your X-zone here.

ORI X-zone

X-zone Com location: ORI X-zone	Created on: 07.04.2014 18:20:14	Last measured value: 05.06.2014 12:31:58	Alarm X-zone: Ok	Battery X-zone: 6,609
X-zone Com ID: 493F87 (4800391)	Last time sent: 05.06.2014 12:32:03	Local timezone: 02:00:00	Alarm Net: Ok	Battery X-zone Com: 14,136

GPS

Time: 20/05/2014 17:31:34	Time zone: 02:00:00	Longitude: 8.730717	Latitude: 52.35361	Altitude: 0
------------------------------	------------------------	------------------------	-----------------------	----------------

Parameter

Monitoring time transmission interval [min]:  Enter 0 to switch off the monitoring.

Licence

X-zone Com license expiration date:  New Licence number:

Figura 8.3: Muestra el estado de aparato tras hacer clic en el ID de aparato. En el momento de la transmisión en Alemania se tiene el horario de verano, por este motivo en tanto zona horaria local se indica 02:00:00 (UTC+2 - véase capítulo 7.1.5).

En el caso de una alarma de intervalo de envío se le avisa a Usted por medio de un e-mail y el color del símbolo del aparato cambia a rojo. Al hacerse la confirmación de la alarma, en el mapa el símbolo del aparato cambia de rojo a verde. En la vista del mapa puede pasar a la barra del menú principal haciendo clic en el punto de menú [Map].



Figura 8.4: El color del símbolo del aparato del mapa cambia de rojo a verde tras confirmarse la alarma de intervalo de envío que tenga lugar.

## 8.3 VALORES DE MEDICIÓN M-CLOUD

Haciendo una vez clic en último lugar de medición (2) accederá a los actuales datos de medición del aparato. Aquí pueden marcarse los sensores de medición individuales y seguidamente representar gráficamente sus valores de medición respecto de un espacio cronológico seleccionado o exportarse en tanto fichero CSV.

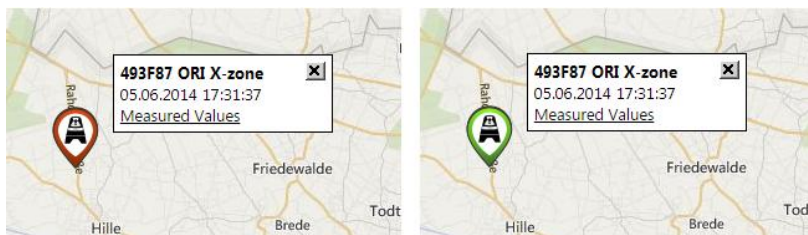

Figura 8.5: Representación gráfica ampliada de los valores de medición de dos sensores de gas del X-zone Com Test\_7.

La serie de datos de varios aparatos pueden mostrarse si marca los checkbox de los lugares de medición correspondientes y luego hace clic. Alternativamente haga clic en la barra de menú [Alle valores de medición] a fin de mostrar para la selección todos los aparatos con los sensores correspondientes.

### INDICACIÓN



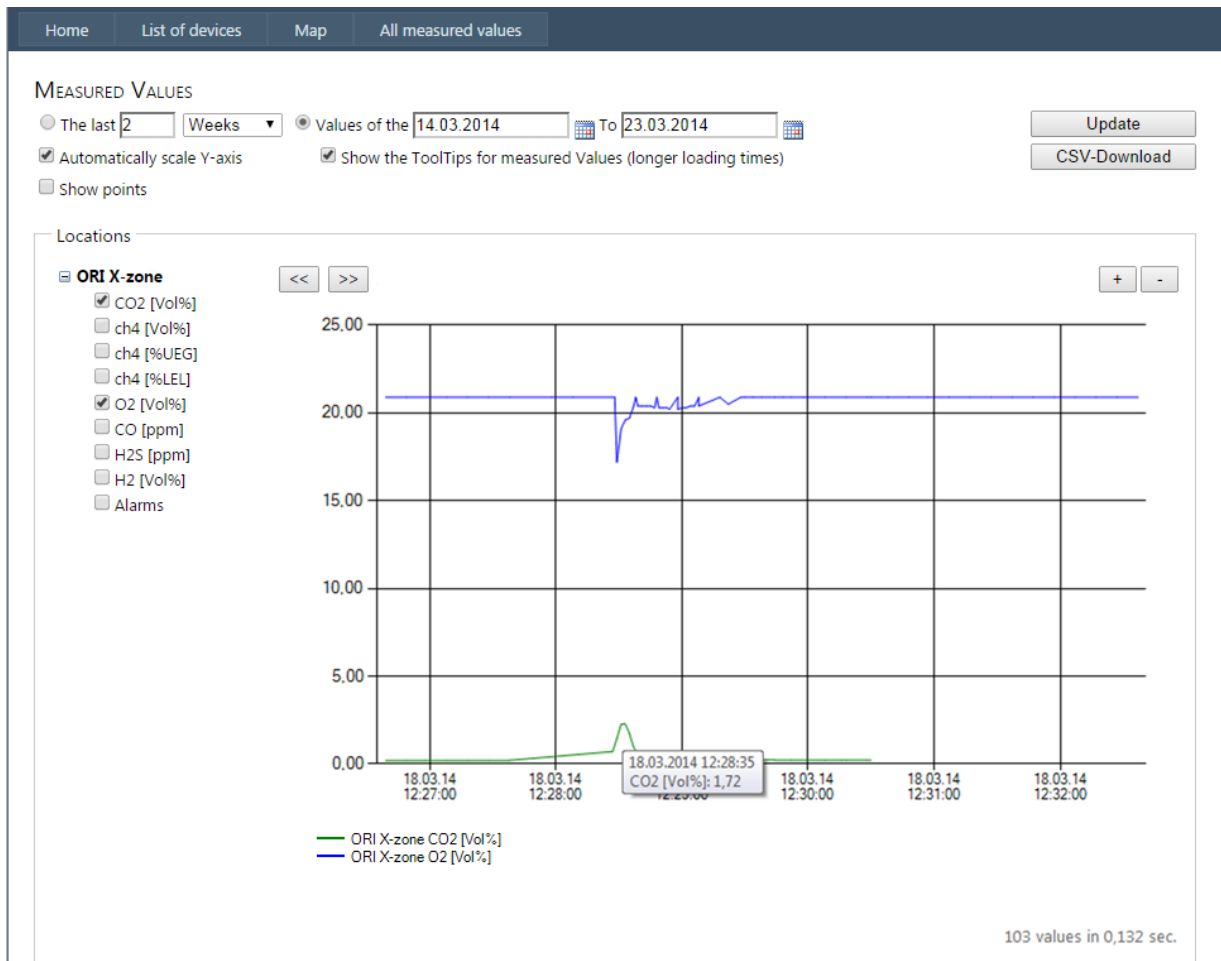



Es posible representar gráficamente o exportarse varias series de datos de aparatos con diversos ID. Por lo demás pueden mostrarse también diversos lugares de medición de un aparato con diversos sensores.



## 8.4 REPRESENTACIÓN DE MAPA MCLLOUD

Haciendo una vez clic en [Karte] en la barra de menú principal se muestra la posición de todos los aparatos registrados en una tarjeta (señalización seleccionable entre vista de tarjeta, vista de pájaro o automática).

Símbolos de aparato mostrados	
	X-zone Com
	Cámara
	Mlog
	Tomador de muestras



Figura 8.6: Todos los aparatos registrados se muestran en un mapa.

Pasando por un símbolo de aparato con el cursor de ratón aparece a la derecha del símbolo una pequeña ventana con el ID del aparato, el nombre del aparato, la hora del último envío de datos y un enlace a los valores de medición.

Con la ruedecilla del ratón o por medio del símbolo de la lupa de arriba a la izquierda puede ampliar o disminuir el mapa.

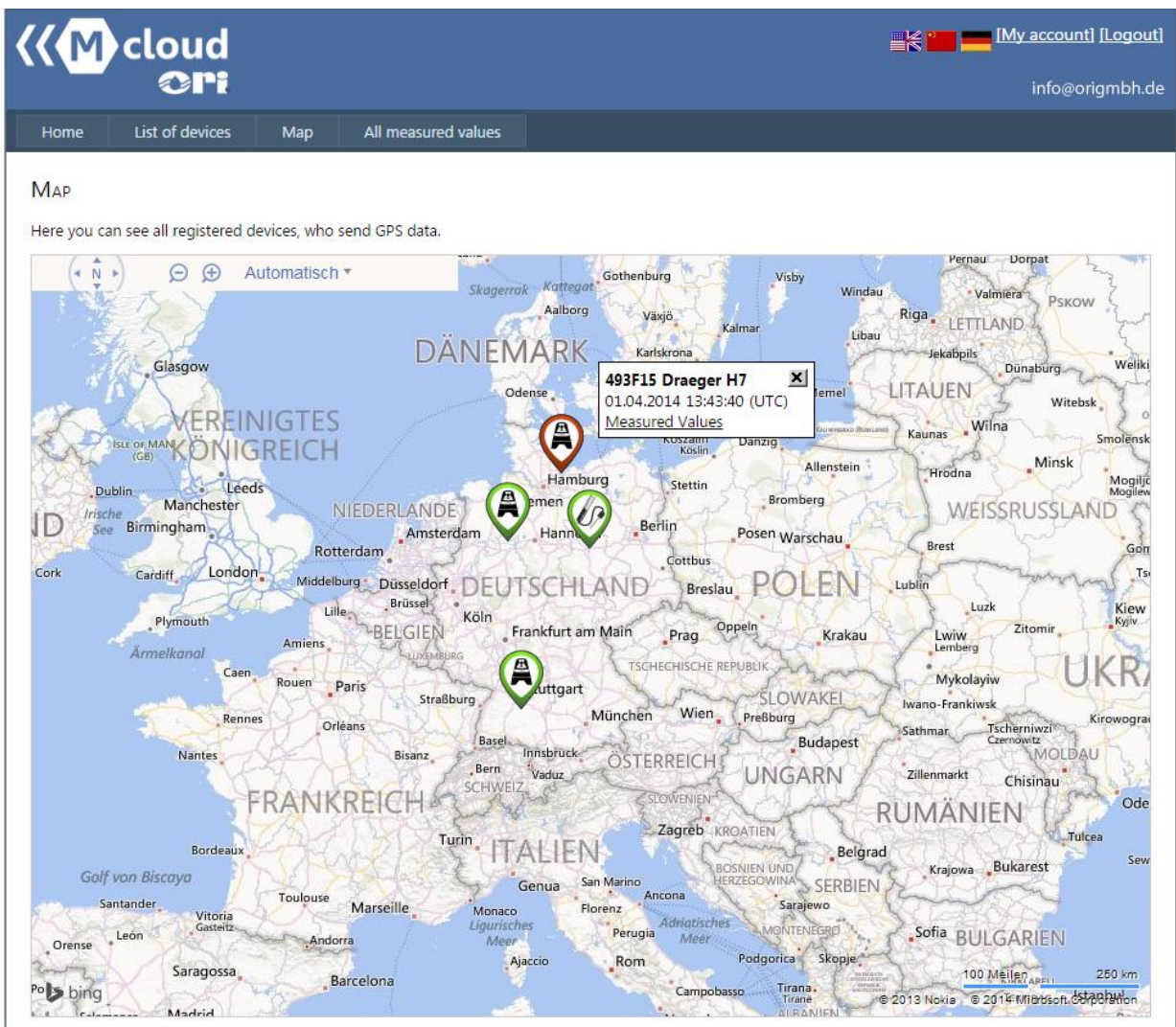

Figura 8.7: Posición de los aparatos registrados en la representación del mapa. En el caso de demás ampliaciones se conmuta automáticamente a la vista de pájaro. De los dos aparatos aquí reconocibles uno de ellos hace mucho tiempo que no ha enviado datos a Mcloud (símbolo de aparato rojo).



## 9 MANTENIMIENTO Y CONSERVACIÓN

### 9.1 INTERVALOS

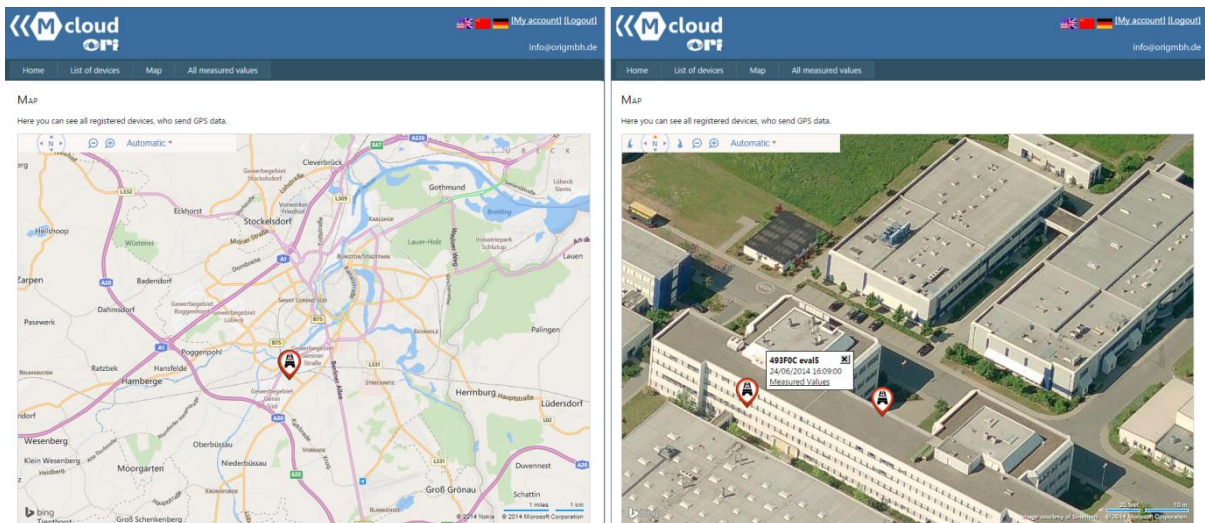
**X-zone Com:** el aparato ha de someterse regularmente a inspecciones y trabajos de mantenimiento que han de correr a cargo del personal especializado.

**Cargador de batería:** el cargador de batería no requiere mantenimiento especial. En el caso de que el servicio sea necesario, lo lleva a cabo el fabricante o personas por él autorizadas.

### 9.2 LIMPIEZA

El aparato debe limpiarse exclusivamente con un paño húmedo.

#### INDICACIÓN



**No emplee para la limpieza ningún producto que contenga alcohol**

### 9.3 CAMBIO DE LA BATERÍA EN CASO DE REPARACIÓN

#### ADVERTENCIA



**¡Peligro de explosión!**

No abrir el compartimento de la batería en una atmósfera con peligrosidad de explosión. La batería es una pieza autorizada respecto de la susceptibilidad de explosión y la desconexión y conexión de la tensión de suministro sólo debe llevarse a cabo en un entorno no susceptible de explosiones.

#### CUIDADO



**¡Daño del aparato!** Al abrir la carcasa sujete la pieza superior del X-zone Com de modo que esta pieza misma y la batería no se caigan al suelo y se dañen.



Figura 9.1: Abrir el compartimento de la batería.

Aflojar los 6 tornillos de la carcasa de la cara inferior.

Retirar la pieza superior.

Retirar la clavija de conexión de la batería, soltar las bridas de sujeción, tomar la batería.

El ensamblaje del X-zone Com se realiza en sentido inverso. Para ello apriete a mano los tornillos.

# 10 ANEXO

## 10.1 CÓDIGOS DE ERROR

Código de error	Señalización de pantalla (X-zone Com)	Descripción	Solventación
<b>Fallo de aparato</b>			
1	Check sum error	Error de comprobación de memoria – memoria de configuración	Ponerse en contacto con el servicio de ORI.
2	Check sum error	Error de comprobación de memoria - memoria de datos	Ponerse en contacto con el servicio de ORI.
3	Internal HW error	<i>Real time clock</i> no funciona	Ponerse en contacto con el servicio de ORI.
6	Internal HW error	<i>RS485 bridge</i> no funciona	Ponerse en contacto con el servicio de ORI.
<b>Batería error</b>			
9	Battery HW error	Error de comunicación con el controlador de la batería	Ponerse en contacto con el servicio de ORI (¿batería internamente conectada?)
10	Battery main alarm	Alarma principal de la batería	Ponerse en contacto con el servicio de ORI.
11	Battery pre-alarm	Alarma previa de la batería	Cargar X-zone Com.
12	Battery empty	Batería completamente descargada	Cargar X-zone Com.
14	Battery too cold	Temperatura de la batería demasiado baja	Interrumpa la carga y coloque el X-zone Com en un lugar más caliente.
15	Charging error	Error de carga de batería	Error de carga de batería - ponerse en contacto con el servicio de ORI.
<b>GPS error</b>			
16	GPS HW error	El módulo GPS no funciona	Ponerse en contacto con el servicio de ORI.
17	GPS error	Error GPS no específico	Ponerse en contacto con el servicio de ORI.
<b>GSM error</b>			
20	GSM modem error	GSM módem no funciona	¿Módem internamente conectado?
21	No SIM card	Ninguna tarjeta SIM puesta	Colocar la tarjeta SIM.
22	SIM not working	La tarjeta SIM no funciona	Colocar una nueva tarjeta SIM.
23	SIM: Wrong PIN	Tarjeta SIM: PIN erróneo	Configure el PIN correcto por medio del Manager Software.
24	SIM blocked	Tarjeta SIM bloqueada: introducción de PUK necesaria	Coloque la tarjeta SIM en el teléfono móvil y active la tarjeta introduciendo la PUK ( <i>Personal Unblocking Key</i> ).
25	Roaming error	<i>Roaming</i> no autorizado	Verwenden Sie eine entsprechende tarjeta SIM.
26	GSM error	Error desconocido de GSM	configure y controle los ajustes GSM/GPRS por medio del Manager Software (véase capítulo 5.4.3).
27	No GSM network	No se ha encontrado ninguna red GSM	Modifique la posición del aparato y controle: <ul style="list-style-type: none"> <li>la intensidad de la señal (véase capítulo 5.4.3)</li> <li>la antena</li> <li>la validez de la tarjeta SIM y su haber</li> </ul>
28	Wrong APN login	Error de autenticación de GPRS: indicación APN errónea	Controle por medio del Manager Software la corrección de las siguientes introducciones: <ul style="list-style-type: none"> <li>APN de su ofertor de telefonía</li> <li>nombre de usuario</li> <li>contraseña</li> </ul>
29	GPRS error	Error desconocido de GPRS	Configure y controle los ajustes GSM/GPRS por medio del Manager Software (véase capítulo 5.4.3).
30	IP error	Sin dirección IP	Configure y controle los ajustes GSM/GPRS por medio del Manager Software (véase capítulo 5.4.3).
31	Unknown mail server	<i>Mail host, el nombre no puede borrarse</i> (asignarse)	Introduzca un nombre de servidor de e-mail válido.
<b>SMS error</b>			
40	Unknown phone no.	Número de teléfono desconocido	Configuración por medio del Manager Software.

41	SMS error	Error de SMS desconocido	Configuración por medio del Manager Software.
42	SMS not sent	El SMS no pudo enviarse	Controle: <ul style="list-style-type: none"> <li>ajustes de SMS por medio del Manager Software</li> <li>el haber en el caso de tarjeta Prepaid</li> </ul>
43	Wrong PIN in SMS	Recibido SMS con PIN falso	Introduzca por medio del Manager Software el PIN de lectura y de "Admin" y empléelo al enviar un SMS al X-zone Com (véase capítulo 5.4.5)
47	Unknown e-mail user	Usuario de e-mail desconocido	Controle por medio del Manager Software: <ul style="list-style-type: none"> <li>el nombre de usuario</li> <li>la contraseña</li> </ul>
48	Mailbox full	Sección de e-mail llena	Controle su sección de e-mail
49	Email rejected	El e-mail ha sido rechazado	controle los justes de e-mail por medio del Manager Software
50	Email not sent	El e-mail no pudo enviarse	Controle por medio del Manager Software: <ul style="list-style-type: none"> <li>la intensidad de la seña (véase capítulo 5.4.3)</li> <li>los ajustes de e-mail</li> </ul>
<b>Systemfehler</b>			
85	No time set	Sin ajustes de hora y fecha	Ponga la fecha y la hora por medio del Manager Software (véase capítulo 5.4.1)
86	Incompatible SW	Error de comunicación Modbus con el X-zone 5x00	Actualice el software del X-zone 5x00 y del X-zone Com.
89	X-zone missing	X-zone 5x00 ha sido desconectado del X-zone Com	Controle: <ul style="list-style-type: none"> <li>la conexión al X-zone 5x00.</li> <li>los ajustes Modbus en el X-zone 5x00 (115200, E, 8,1)</li> </ul>

## 10.2 LISTA DE PEDIDOS

Descripción	Número de pedido ORI	Número de pedido Dräger
<b>X-zone Com Set –</b>  II 2C Ex ib [Ia IIC Ga] [Ib IIC] IIB T3/T4 Gb		
Unidad de comunicación para Dräger X-zone 5x00	8094 100	8324383
<b>Cargador de batería/bloque de alimentación:</b>		
Cargador de batería	8094 114	8324374
cable para Europa	8094 142	8325391
cable para Gran Bretaña	8094 141	8325392
cable para Australia	8094 140	8325393
<b>Paquete de baterías</b>	8094 106	8324376
<b>Cables:</b>		
RS232 para conexión al X-zone Com / PC	8094 120	8324379
RS 485 para conexión al X-zone Com / X-zone	8094 118	8324373
<b>Software</b>		
Manager Software para parametrage del X-zone Com	5415 045-2	
Licencia Mcloud de 12 meses	5415 061	8325346
Licencia Mcloud de 36 meses	5415 063	8325347
<b>Piezas de repuesto:</b>		
Juego de sujeción (para la conexión mecánica segura entre X-zone y X-zone Com por medio de un cinturón)	8094 117	
Juego de cinturón para sujeción	8094 136	8324377
Pie para X-zone Com con soporte de sujeción	8094 135	8324384
<b>Piezas de repuesto:</b>		
Módem GSM-GPRS	5415 029	8324375
Batterie/batería	8094 106	8324376
Antena GSM X-zone Com	8094 108	8324372

## 10.3 ACTUALIZACIÓN DE FIRMWARE

Para la actualización de firmware del X-zone Com, necesita una conexión entre el ordenador y X-zone Com vía Bluetooth o un cable de enlace RS232, también el software "FirmLoader.exe" y un fichero actual de firmware "XCOM VX\_XXX.fmw". Éste podrá solicitarlo a su servicio de asistencia de ORI o Dräger. Antes de proseguir, determine el número de puerto COM de su conexión caso que no lo conozca (véase capítulo 5.1). Seguidamente proceda de la siguiente manera:

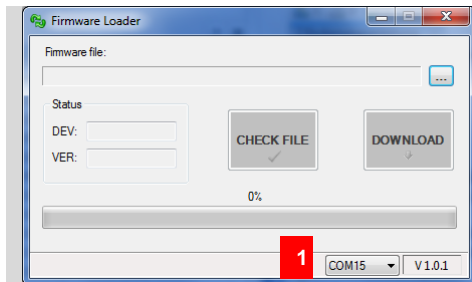

1 Inicie "FirmLoader.exe" y seleccione el puerto COM.

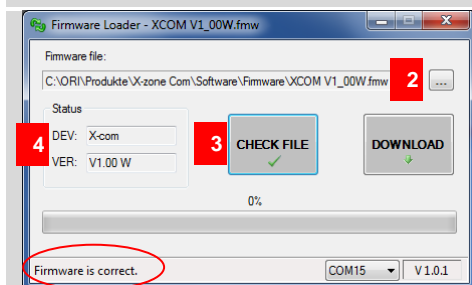

2 Seleccione el fichero de firmware actual.

3 Haga clic en la tecla [CHECK FILE] para probar el firmware seleccionado.

4 En los casilleros "DEV" y "VER" se le muestran el tipo de aparato y el número de la versión del firmware seleccionado. En la barra de estado de abajo a la izquierda aparece un texto informativo.

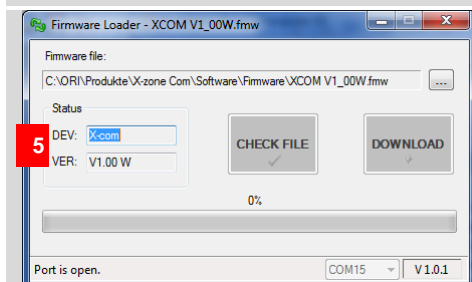

5 Controle si se trata de un firmware para un X-zone Com.

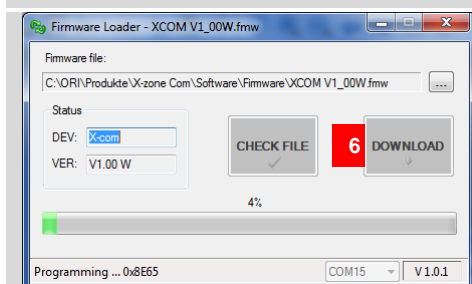

6 Entonces haga clic en [DOWNLOAD] para reproducir el firmware en su X-zone Com.

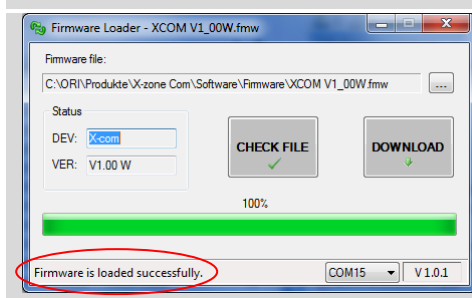

Cuando el firmware se haya descargado con éxito se mostrará esto mismo en la barra de estado de abajo a la izquierda.

Concluya el proceso "Firmware Loader" haciendo clic en , que se encuentra en el menú de ventana.

### INDICACIÓN



*En el caso de una conexión existente con un X-zone 5X00 tiene lugar durante el la DESCARGA una alarma de aparato.*

Caso que la actualización no haya tenido éxito, sírvase comprobar todas las conexiones. Asegúrese de que en el caso de una conexión Bluetooth el ordenador reconozca su X-zone Com y de que la distancia entre ambos aparatos no sea demasiado grande ni se vea obstaculizada por objetos colocados entre ellos. Compruebe el número de puerto COM.

Seguidamente inicie de nuevo la actualización.

## 10.4 CERTIFICADOS

	<h1>IECEX Certificate of Conformity</h1>	
<b>INTERNATIONAL ELECTROTECHNICAL COMMISSION</b> <b>IEC Certification Scheme for Explosive Atmospheres</b> <small>for rules and details of the IECEx Scheme visit <a href="http://www.iecex.com">www.iecex.com</a></small>		
Certificate No.:	<input type="text" value="IECEX FTZU 14.0013X"/>	issue No.: <input type="text" value="0"/>
Status:	<input type="text" value="Current"/>	
Date of Issue:	<input type="text" value="2014-06-13"/>	Page 1 of 3
Applicant:	<b>ORI-Abwassertechnik GmbH &amp; Co. KG</b> Bollacken 2, 32479 Hille Germany	
Electrical Apparatus: <i>Optional accessory:</i>	<b>Communication Equipment Device COM</b>	
Type of Protection:	<b>Intrinsic safety</b>	
Marking:	<b>Ex ib [ia IIC Ga] [ib IIC] IIB T3/T4 Gb</b>	
<i>Approved for issue on behalf of the IECEx Certification Body:</i>	Dipl. Ing. Lukáš Martinák	
<i>Position:</i>	Head of the Certification Body	
<ol style="list-style-type: none"><li>1. This certificate and schedule may only be reproduced in full.</li><li>2. This certificate is not transferable and remains the property of the issuing body.</li><li>3. The Status and authenticity of this certificate may be verified by visiting the Official IECEx Website.</li></ol>		
Certificate issued by:		





Physical Technical Testing Institute  
Ostrava – Radvanice



## EC-Type Examination Certificate

(1)

(2)

Equipment or Protective Systems Intended for Use  
in Potentially Explosive Atmospheres  
(Directive 94/9/EC)

(3) EC-Type Examination Certificate Number:

**FTZÚ 14 ATEX 0048X**

(4) Equipment or protective system: **Communication Equipment Device.COM**

(5) Manufacturer: **ORI Abwassertechnik GmbH & Co. KG**

(6) Address: **Bollacken 2, D-32479 Hille, Germany**

(7) This equipment or protective system and any of acceptable variation thereto is specified in the schedule to this certificate and the documents therein referred to.

(8) The Physical Technical Testing Institute, notified body number 1026 in accordance with Article 9 of the Council Directive 94/9/EC of 23 March 1994, certifies that this equipment or protective system has been found to comply with the Essential Health and Safety Requirements relating to the design and construction of equipment and protective systems intended for use in potentially explosive atmospheres given in Annex II to the Directive.

The examination and test results are recorded in confidential Report N°:

**14/0048 dated 13.06.2014**

(9) Compliance with Essential Health and Safety Requirements has been assured by compliance with:

**EN 60079-0:2012, EN 60079-11:2012, EN 60079-26:2007**

(10) If the sign "X" is placed after the certificate number, it indicates that the equipment or protective system is subject to special conditions for safe use specified in the schedule to this certificate.

(11) This EC-Type Examination Certificate relates only to the design, examination and testing of the specified equipment or protective system in accordance to the directive 94/9/EC. Further requirements of the Directive apply to the manufacturing process and supply of this equipment or protective system. These are not covered by this certificate.

(12) The marking of the equipment or protective system shall include following:

 **II 2G Ex ib [ia IIC Ga] [ib IIC] IIB T3/T4 Gb**

This EC-Type Examination Certificate is valid till: **13.06.2019**

Responsible person:

  
Dipl. Ing. Lukáš Martinák  
Head of Certification Body



Date of issue: 13.06.2014

Page: 1/4

This certificate is granted subject to the general conditions of the FTZÚ, s.p.  
This certificate may only be reproduced in its entirety and without any change, schedule included.

FTZÚ, s.p., Pikartská 1337/7, 716 07 Ostrava-Radvanice, Czech Republic,  
tel +420 595 223 111, fax +420 596 232 672, ftzu@ftzu.cz, www.ftzu.cz

\*\*\*



Physical Technical Testing Institute  
Ostrava – Radvanice



## Supplement No. 1 to EC-Type Examination Certificate

- (1)
- (2) **Equipment or Protective Systems Intended for Use  
in Potentially Explosive Atmospheres  
(Directive 94/9/EC)**

- (3) EC-Type Examination Certificate Number:

**FTZÚ 14 ATEX 0048X**

- (4) Equipment or protective system: **Communication Equipment Device.COM**

- (5) Manufacturer: **ORI Abwassertechnik GmbH & Co. KG**

- (6) Address: **Bollacken 2, D-32479 Hille, Germany**

- (7) This supplement of certificate is valid for: - modification of certified apparatus  
- modification of apparatus marking  
- new model (variant) external power supply **02617PS**
- (8) Modification of certified apparatus (protective system) and any of its approved variants are specified in documentation, list of which is mentioned in schedule of this certificate.
- (9) This supplement to type examination certificate is valid only for type examination of design and construction of product sample in accordance with Annex 3 Paragraph 6) of Directive No. 94/9/EC. The Directive contains another requirements, which manufacturer shall fulfil before products are placed on market or introduced in service.
- (10) Safety requirements of modified parts were fulfilled by satisfying the following standards:  
**EN 60079-0:2012, EN 60079-11:2012, EN 60079-26:2007**
- (11) Marking of equipment shall contain symbols:

 **II 2G Ex ib [ia IIC Ga] [ib IIC] IIB T3/T4 Gb**

 **II (2)G [Ex ib Gb] IIB** zdroj 02617PS

- (12) This type examination certificate is valid till: **13.06.2019**

Responsible person:

  
Dipl. Ing. Lukáš Martinák  
Head of Certification Body



Date of issue: 20.10.2014

Page: 1/3

This supplement to certificate is granted subject to the general conditions of the FTZÚ, s.p.  
This supplement to certificate may only be reproduced in its entirety and without any change, schedule included.

FTZÚ, s.p., Pikartská 1337/7, 716 07 Ostrava-Radvanice, Czech Republic,  
tel +420 595 223 111, fax +420 596 232 672, ftzu@ftzu.cz, www.ftzu.cz